



Surgical Instruments



 Princeton
Medical Group



1601 Championship Blvd, Suite 233 Franklin, TN 37064
800 – 875 – 0869 / Fax: 615 – 791 – 8598

www.princetonmedical.net

Catalog Look-Up Instructions

By Product Category:

- On the index page in the front of the catalog, find the category you are looking for (i.e. category 09 - scissors). All category numbers are located at the top of each page.
- Each product has a category number associated with it.....it will be the first two numbers of the product code. For example, all scissors begin with '09'.
- The two numbers after the dash in the product code will reflect the length/dimension of the product (i.e. 09970-18)

By Product Name:

- All products listed by proper name are listed in the index in the back of the catalog (pages lined in gray).
- For example, when looking for Metzenbaum scissors by proper name, go to the back section of the catalog. All names are listed in alphabetical order.
- All page numbers are located at the bottom of each page.

For your convenience, each product will only be listed/shown once in this catalog.

Catalog Index

03: Diagnostics	33, 34: Bone Surgery
05: Anesthesia	41: Neurosurgery
07: Scalpels	43, 44: Ophthalmology
09: Scissors	45: Otology
10: Micro Scissors	47: Rhinology
11: Thumb & Tissue Forceps	49: Mouth & Tongue
12: Microsurgery Forceps Trauma Bulldog Clamps	51: Tonsils
13: Hemostatic Forceps	53: Larynx
15: Towel Forceps	55: Tracheotomy
17: Dressing Forceps	57: Thorax
19: Retractors	61: Cardiovascular Surgery
21: Probes, Cotton Applicator	63: Gall & Kidney
23: Trocars	65: Intestines, Stomach
25: Needle Holders	67: Urology
27: Suturing Instruments	69: Rectum
29: Sterilization Instruments	71: Gynecology
31: Plaster of Paris	73: Obstetrics
	75: Podiatry, Dermatology

In addition to the above categories, Princeton Medical also carries the following products not listed in this catalog:

- Laparoscopic Instruments
- Arthroscopic Instruments
- Sterilization Containers

Nystagmusbrille
 Nystagmus spectacles
 Anteojos para nistagmo
 Occhiali nistagmo



FRENZEL

03167-03
 Beleuchtete Nystagmusbrille
 mit querliegendem
 Batteriehandgriff und festen
 Gläsern

Energiequelle:
 2 Stück 4-Volt-Lämpchen
 2 Stück Baby-Zellen 1.5 V

03167-03
 Anteojos para nistagmo, con
 iluminación, con mango para
 pilas en forma horizontal,
 vidrios fijos,

Alimentación:
 2 unidades de bombillos de
 4 voltios
 2 unidades de pilas de
 1.5 voltios

03167-03
 Nystagmus spectacles for
 observation of the eyes during
 examination of the vestibular
 apparatus, with battery handle
 and fixed glasses. Illuminated
 on inside of lenses.

Source of energy:
 2 bulbs 4-volt
 2 baby-battery cells 1.5 V

03167-03
 Occhiali Nistagmo illuminati
 con manipolo a batteria,
 lenti fisse.
 Per la rilevazione della reazione
 patologica del nistagmo.

Alimentazione:
 2 lampadine 4 Volt
 2 batterie 1,5 Volt

Stirnlampen
Head Lights
Lámparas frontales
Lampade frontali



03180-94



03180-93



ZIEGLER
03180-90
compl.



03180-92

03180-90
Ziegler-Stirnspiegel,
komplett, mit schwarzem
Stirnreifen,
mit Kugelgelenk,
90 mm ø

03180-90
Ziegler Head Mirror,
complete with black head
band, with ball socket,
90 mm ø

03180-90
Ziegler espejo frontal, com-
pleto con cinta negra,
con articulación,
90 mm ø

03180-90
Specchio frontale, Ziegler,
completo con fascia nera,
con snodo sferico,
90 mm di ø

03180-92
Stirnreifen, allein

03180-92
head band, only

03180-92
cinta, suelta

03180-92
fascia, sola

03180-93
Spiegel, allein
90 mm ø

03180-93
Mirror, only
90 mm ø

03180-93
Espejo, suelto
90 mm ø

03180-93
Specchio,
solo 90 mm ø

03180-94
Gelenk für Stirnreifen

03180-94
Socket joint for head bands
only

03180-94
Articulación para cintas fron-
tales suelta

03180-94
Snodo sferico per fascie
frontali

Stirnlampen
Head Lights
Lámparas frontales
Lampade frontali



03195-00
CLAR

komplett mit Stirnstreifen und Kabel
complete with head band and cable
completo con cinta frontal y cable
completa con fascia frontale e cordone



03195-01

Spiegel aus Glas ohne Fassung
Glass Mirror without frame
Reflector de cristal, sin montura
Riflettore di cristallo, senza montatura



03195-06
6 Volt



03195-07 Kleintransformator
220 Volt = 0 - 10 Volt / 3 Watt
Mini-Transformer Unit
Transformador eléctrico pequeño
Mini-trasformatore elettrico

03195-08 Kleintransformator
110 Volt = 0 - 10 Volt / 3 Watt
Mini-Transformer Unit
Transformador eléctrico pequeño
Mini-trasformatore elettrico

03195-09 Clar-Spiegel-Gelenkverbindung
Clar special socket joint
Articulación especial de Clar
Snodo speciale di Clar

03195-04 Stirnstreifen, alleine
head band, only
cinta frontal, suelta
fascia frontale, sola

03195-10 Clar Kopfsprange allein aus Metall
mit Kabellaschen und
Fixierschraube mit Gelenk
Clar spring metal head band only,
with cable clips and fixing screw
with socket joint
Casco frontal de resorte metálico
suelto de Clar, con bridas de
cable, y tornillo de sujeción con
articulación
Fascia metallica a casco di Clar,
solo, con portacordoni e vite di
fissaggio a snodo

Stethoskope
Stethoscopes
Estetoscopios
Stetoscopi

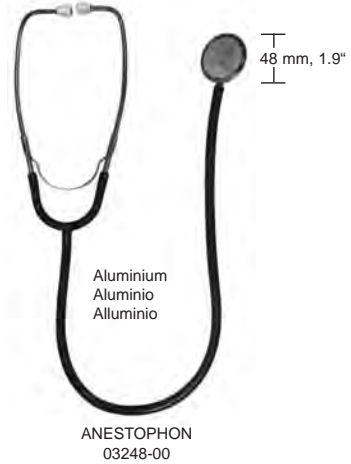
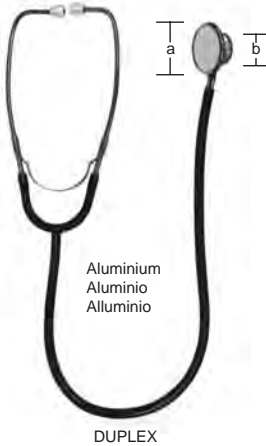

	a	b	
03246-00	48 mm, 1.9"	30 mm, 1.2"	
03246-01	39 mm, 1.5"	25 mm, 1.0"	Baby
03246-02	21 mm, 0.8"	21 mm, 0.8"	Neonatal



Perkussionshämmer
 Percussion Hammers
 Martillos de percusión
 Martelli da percussione



TAYLOR - USA Mod.
 03288-17 17 cm, 6 3/4"
 03288-20 20 cm, 8"



BABINSKY
 03292-22 22 cm, 8 3/4"



TROEMNER
 03294-24 24 cm, 9 1/2"



DEJERINE
 03304-20 20 cm, 8"



BERLINER
 03306-17 17 cm, 6 3/4"

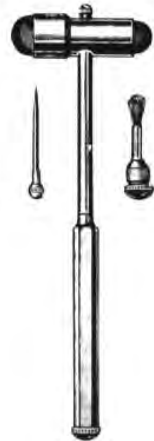

BUCK
 03308-18 18 cm, 7"

Prüf- und Meßinstrumente
 Examination and Measuring Instruments
 Instrumentos para exámenes y medidas
 Strumenti per esaminare e misurare

Dynamometer
 Dynamometer
 Dinamómetro
 Dinamometro



COLLIN
 03310-01 Erwachsene, Adult,
 adultos, adulti
 03310-02 Kind, child, niños, bambini

Winkelmesser
 Goniometer
 Goniómetro
 Goniometro



MOELTGEN
 03312-01



Finger-Goniometer
 Finger goniometer
 Goniómetro para dedos
 Goniometro per le dita
 03314-01



WARTENBERG
 03320-19 19 cm, 7 1/2"



aus Stahl
 of steel
 de acero
 di acciaio
 03350-15 1,5 m 0.6"

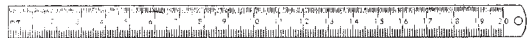

Metall		
03340-10	10 cm	4"
03340-15	15 cm	6"
03340-20	20 cm	8"
03340-30	30 cm	12"
03340-50	50 cm	20"

Schieblehren
Calipers
Calibres
Calibro



03360-21
21 cm, 8 1/4"

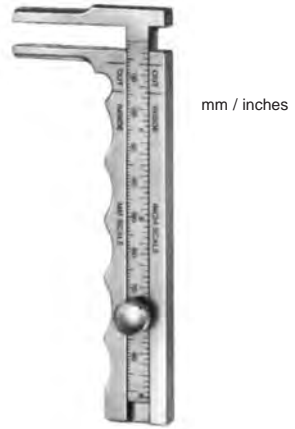

TOWNLEY
03361-10
11,5 cm, 4 1/2"

Saugrohre
Suction tubes
Tubos de aspiración
Cannule per aspirazione



POOLE 20 cm, 8"
05130-05 5.5 mm ø, 0.2"
(17 Fr.)

05130-10 10 mm ø, 0.4"
(30 Fr.)



POOLE 19 cm, 7 1/2"
05140-05 5.5 mm ø, 0.2"
(17 Fr.)

05140-08 8 mm ø, 0.3"
(23 Fr.)



compl. BABY-YANKAUER
05150-21 21 cm, 8 1/4"

compl. YANKAUER
05150-27 27 cm, 10 1/2"

Saugrohre
 Suction tubes
 Tubos de aspiración
 Cannule per aspirazione

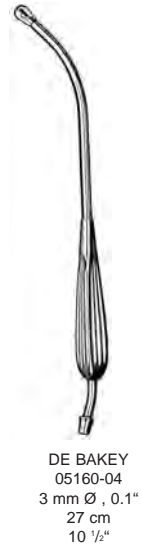
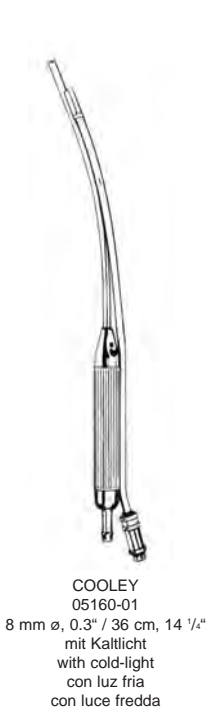
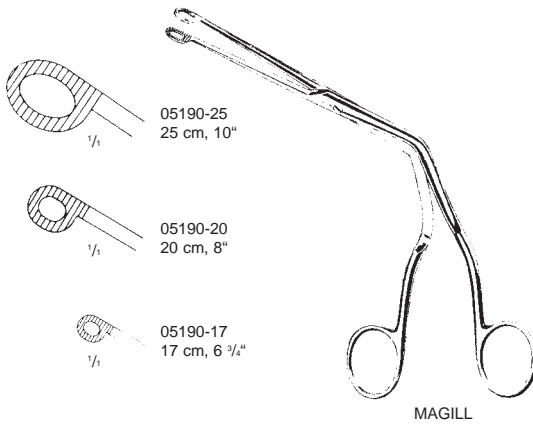

Laryngoskope
Laryngoscopes
Laringoscopios
Laringoscopi



McINTOSH

Fig. 0	5,5 cm	2 1/4"	05210-00
Fig. 1	7,5 cm	3"	05210-01
Fig. 2	9,0 cm	3 1/2"	05210-02
Fig. 3	11,0 cm	4 3/8"	05210-03
Fig. 4	13,5 cm	5 1/4"	05210-04

Cold light
05211-00
05211-01
05211-02
05211-03
05211-04



05239-03
Halogen-Lampe
Halogen Lamp
Lámpara Halógena
Lampada Alogena



05239-01
f./p. Fig. 0-1



05239-02
f./p. Fig. 2-4



FOREGGER

Fig. 0	5,5 cm	2 1/4"	05220-00
Fig. 1	7,0 cm	2 3/4"	05220-01
Fig. 2	9,0 cm	3 1/2"	05220-02
Fig. 3	11,0 cm	4 3/8"	05220-03
Fig. 4	13,5 cm	5 1/4"	05220-04

Cold light
05221-00
05221-01
05221-02
05221-03
05221-04



05239-03
Halogen-Lampe
Halogen Lamp
Lámpara Halógena
Lampada Alogena



05239-01
f./p. Fig. 0-1



05239-02
f./p. Fig. 2-4

Laryngoskope
Laryngoscopes
Laringoscopios
Laringoscopi

MILLER



05230-00
55 mm, 2 1/2"
Nutzlänge
working length
largo útil
lunghezza utile

für Säuglinge
for babies
para neonatales
per neonati



05230-01
80 mm, 3 1/8"
Nutzlänge
working length
largo útil
lunghezza utile

für Kinder
for children
para niños
per bambini

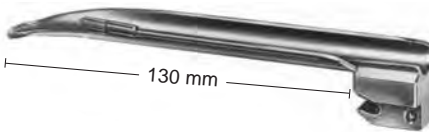

05230-02
130 mm, 5"
Nutzlänge
working length
largo útil
lunghezza utile

für Jugendliche
for adolescents
para adolescentes
per adolescenti



05230-03
170 mm, 6 3/4"
Nutzlänge
working length
largo útil
lunghezza utile

für Frauen
for women
para mujeres
per donne



05230-04
180 mm, 7"
Nutzlänge
working length
largo útil
lunghezza utile

für Männer
for men
para hombres
per uomini



05239-01
f./p. Fig. 0-1



05239-02
f./p. Fig. 2-4

Laryngoskope
Laryngoscopes
Laringoscopios
Laringoscopi



McIntosh

05203-00

Set bestehend aus:
1 Etui
1 Batteriegriff 05234-28
3 Spatel (Fg. 2-4)

Set consisting of:
1 Case
1 Handle
3 Blades (Fg. 2-4)

Juego compuesto de:
1 Estuche
1 Mango
3 Hoja (Fg. 2-4)

Set composto da:
1 Astuccio
1 Manico
3 Spatole (Fg. 2-4)

05204-00

Set bestehend aus:
1 Etui
1 Batteriegriff 05234-28
4 Spatel (Fg. 1-4)

Set consisting of:
1 Case
1 Handle
4 Blades (Fg. 1-4)

Juego compuesto de:
1 Estuche
1 Mango
4 Hoja (Fg. 1-4)

Set composto da:
1 Astuccio
1 Manico
4 Spatole (Fg. 1-4)



Foregger

05223-00

Set bestehend aus:
1 Etui
1 Batteriegriff 05234-28
3 Spatel (Fg. 2-4)

Set consisting of:
1 Case
1 Handle
3 Blades (Fg. 2-4)

Juego compuesto de:
1 Estuche
1 Mango
3 Hoja (Fg. 2-4)

Set composto da:
1 Astuccio
1 Manico
3 Spatole (Fg. 2-4)

05224-00

Set bestehend aus:
1 Etui
1 Batteriegriff 05234-28
4 Spatel (Fg. 1-4)

Set consisting of:
1 Case
1 Handle
4 Blades (Fg. 1-4)

Juego compuesto de:
1 Estuche
1 Mango
4 Hoja (Fg. 1-4)

Set composto da:
1 Astuccio
1 Manico
4 Spatole (Fg. 1-4)

Batteriegriffe, Warmlicht
Battery handles, warm light
Mango de pila, luz caliente
Manico a batteria, luce calda



05233-18 18 mm ø, 3/4"



05234-28 28 mm ø, 1"
05234-37 37 mm ø, 1 1/2"



05238-01 30 mm ø, 1 1/4"

Batteriegriffe, Kaltlicht
Battery handles, cold light
Mango de pila, luz fria
Manico a batteria per luce fredda



05238-02
18 mm \varnothing
 $\frac{3}{4}$ "



05238-03
30 mm \varnothing
1 $\frac{1}{4}$ "

Batteriegriffe, Warmlicht
 Battery handles, warm light
 Mango de pila, luz caliente
 Manico a batteria, luce calda



05240-30 30 mm ø, 1 1/4"
 Griff mit Trafo-Anschluß
 Handle with Transformer-connection
 Mango con conexión al transformador
 Manico con connessione al trasformatore



05241-11 Trafo 110 V
 05241-22 Trafo 220 V

Trafo 110 Volt mit amerikanischem Netzanschluß
 Transformer 110 Volt with american mains connection
 Transformador 110 V con conexión americana
 Trasformatore 110 V ricarica batteria

Trafo 220 Volt mit 1,40 m (55") langem Kabel
 Transformer 220 Volt with cable 1,40 m (55") long
 Transformador, 220 V con cable de 1,40 m (55")
 Trasformatore 220 V ricarica batteria

Laryngoskope
Laryngoscopes
Laringoscopios
Laringoscopi

Operation Laryngoskop:
rostfreier Edelstahl
Rohr: innen matt/außen glänzend
Griff: ganz matt

Operation Laryngoscope:
stainless steel
tube: inner surface matt/outer
surface polished
handle: matt

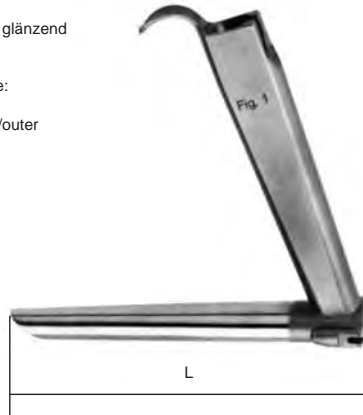

Laringoscopio para operaciones:
Acero inoxidable
Pala: Superficie interior: Mate
Superficie exterior: Brillante
Mango entero: Mate

Laringoscopio a luce
fredda per microchirurgia
endolaringeo
tubo: interiore opaco – esterno lucido
manico: opaco

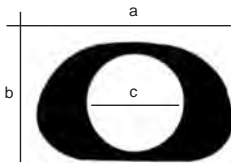

Nr.	L (mm)	a (mm)	b (mm)	c (mm)
05301-01	135	21,8	14,0	13,0
05301-02	152	22,5	14,8	13,0
05301-03	182	23,0	15,0	14,0
05301-04	172	29,5	18,0	17,0
05301-05	172	31,5	21,5	19,0

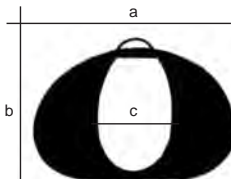

Nr.	L (mm)	a (mm)	b (mm)	c (mm)
05301-06	182	29,0	20,0	16,0 x 26,0
05301-07	222	29,0	20,0	16,0 x 26,0

Laryngoskope
 Laryngoscopes
 Laringoscopios
 Laringoscopi

05300-01/02 Bruststütze für Erwachsene/Kinder bestehend aus:
 05300-03 Stützstange für Erwachsene 34 cm / 05300-06 Ring / 05300-05 Gelenk
 05300-04 Stützstange für Kinder 24 cm / 05300-06 Ring / 05300-05 Gelenk
 05300-01/02 Chest Support for adults/children complete consisting of:
 05300-03 Support rod for adults 34 cm / 05300-06 Ring / 05300-05 Joint
 05300-04 Support rod for children 24 cm / 05300-06 Ring / 05300-05 Joint
 05300-01/02 Soporte pectoral para adultos/niños compuesto de:
 05300-03 para adultos 34 cm / 05300-06 / 05300-05
 05300-04 para niños 24 cm / 05300-06 / 05300-05
 05300-01/02 Braccio portalarinoscopio sternale per adulti/bambini composto da:
 05300-03 per adulti 34 cm / 05300-06 anello / 05300-05 giunto
 05300-04 per bambini 24 cm / 05300-06 anello / 05300-05 giunto

Operationslaryngoskop, Kleinsasser
 Operation laryngoscope, Kleinsasser
 Laringoscopios operativo, Kleinsasser
 Laringoscopia operativa, Kleinsasser

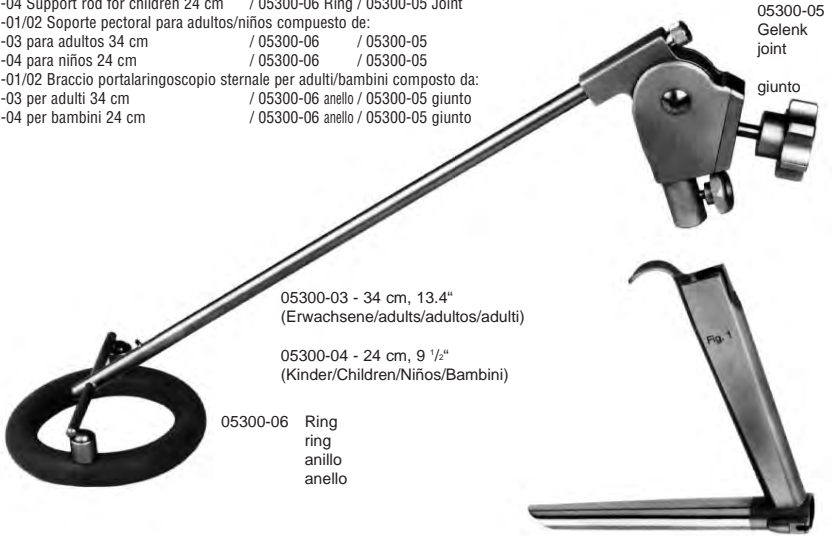

05300-03 - 34 cm, 13.4"
 (Erwachsene/adults/adultos/adulti)
 05300-04 - 24 cm, 9 1/2"
 (Kinder/Children/Niños/Bambini)

05300-06 Ring
 ring
 anillo
 anello

05300-05
 Gelenk
 joint
 giunto

Fiberglas-Lichtträger – Fiberglass-light-guide –
 Portadore de luz fria – portatore di luce fredda
 a fibre di vetro

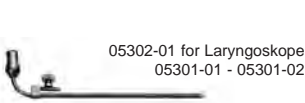

05302-01 for Laryngoskope
 05301-01 - 05301-02

05303-01
 Injektionskanüle für Laryngoskope: 05301-01 - 05301-07
 Injetion drain tube for Laryngoscopes: 05301-01 - 05301-07
 Canúla de inyeccion para laringoscopios: 05301-01 - 05301-07
 Cannula da iniezione per laringoscopi: 05301-01 - 05301-07

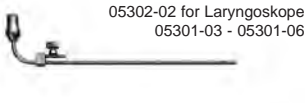

05302-02 for Laryngoskope
 05301-03 - 05301-06

05304-01
 Rauchabsaugrohr für Laryngoskop: 05301-03 - 05301-07
 Suction tube for Laryngoscopes: 05301-03 - 05301-07
 Canúla de succion para laringoscopios: 05301-03 - 05301-07
 Tubo di aspirazione per laringoscopi: 05301-03 - 05301-07

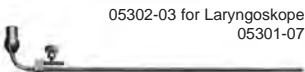

05302-03 for Laryngoskope
 05301-07



Laryngoskope
Laryngoscopes
Laringoscopios
Laringoscopi

HOLINGER Laryngoskop
HOLINGER Laryngoscope
HOLINGER Laringoscopio
HOLINGER Laringoscopi

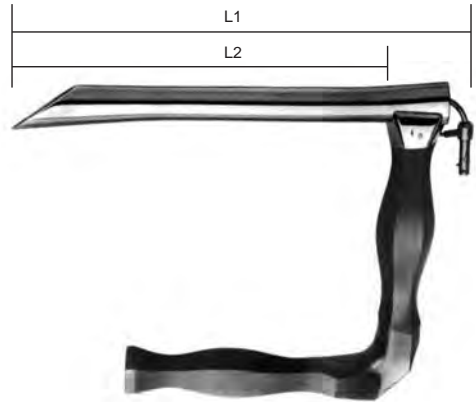

Nr.	L1	L2	Lichtträger light guide Portador de luz portatore di luce
05310-01	180 mm	157 mm	05311-01
05310-02	170 mm	146 mm	05311-02
05310-03	120 mm	98 mm	05311-03
05310-04	90 mm	77 mm	05311-04

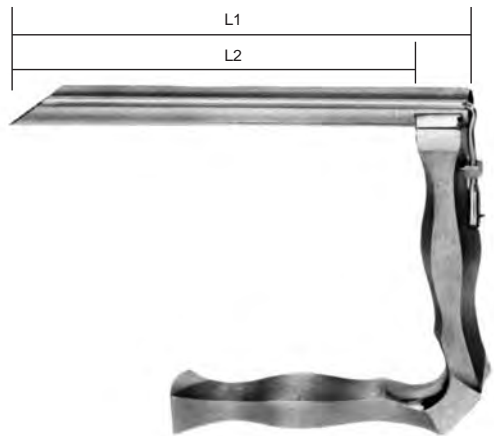

JACKSON Laryngoskop
JACKSON Laryngoscope
JACKSON Laringoscopio
JACKSON Laringoscopi

Nr.	L1	L2	Außen-Dm Outer-dm dm-exterior dm-esterno	Innen-Dm Inner-dm dm-interior dm-interno	Lichtträger light guide Portador de luz portatore di luce
05320-01	160 mm	135 mm	17,5 mm	14,5 mm	05321-01
05320-02	160 mm	135 mm	14,5 mm	12,0 mm	05321-02
05320-03	120 mm	105 mm	14,0 mm	11,5 mm	05321-03
05320-04	90 mm	75 mm	13,0 mm	10,0 mm	05321-04

Skalpell-Griffe
 Scalpel Handles
 Mangos de bisturíes
 Manici per lama bisturi

passend zu den Klingen
 for blades
 para las hojas
 per lama bisturi

(A) No. 10, 11, 12, 13, 14, 15, 16, 17, 18, 19

(B) No. 20, 21, 22, 23, 24, 25



07103-00
 Fig. 3

(A)



07103-01
 Fig. 3 grad.

(A)



07103-02
 Fig. 3 L

(A)

Skalpelli-Griffe
 Scalpel Handles
 Mangos de bisturíes
 Manici per lama bisturi



07104-00
 Fig. 4

(B)



07104-02
 Fig. 4 L

(B)



07105-02
 Fig. 4 L

(B)

Skalpell-Griffe
Scalpel Handles
Mangos de bisturíes
Manici per lama bisturi



07106-01
14,5 cm 5 3/4"



07106-02
14 cm 5 1/2"



Skalpelli-Griffe
Scalpel Handles
Mangos de bisturíes
Manici per lama bisturi



07107-00
Fig. 7

(A)



07107-01
Fig. 7K

(A)



07107-03

(A)



07107-04

(A)

Skalpell-Griffe
Scalpel Handles
Mangos de bisturíes
Manici per lama bisturi



07108-00
Fig. 8

(B)



07109-03
Fig. 3 L

(A)

Skalpell-Griffe
Scalpel Handles
Mangos de bisturíes
Manici per lama bisturi



07161-00 07162-00 07165-00 07167-00

Packung mit 10 Stück
box of 10
en cajas de 10 pzas
confezione di 10

07109-10 10,0 cm, 4"
07109-13 13,0 cm, 5"
07109-15 15,5 cm, 6"

Skalpell-Klingen, Steril
 Scalpel Blades, Sterile
 Hojas de bisturí, estéril
 Lame per bisturi, sterili



07110-00



07111-00



07112-00



07113-00



07115-00



07116-00



07118-00



07119-00



07120-00



07121-00



07122-00



07123-00



07124-00



07125-00



Packung mit 100 Stück
 in packages of 100 each
 en cajas de 100 c/u
 confezione di 100 pezzi

Skalpellklingen-Entferner
 Scalpel Blade Remover
 Quita hojas
 Togli lama



07130-00

Einmal-Skalpelle, Steril
 Disposable Scalpels, Sterile
 Bisturys uso único, estériles
 Bisturi monouso, sterili



07210-00

Packung mit 10 Stück
 in packages of 10 each
 en cajas de 10 c/u
 confezione di 10 pezzi



07211-00



07212-00



07213-00



07215-00



07218-00



07219-00



07220-00



07222-00



07224-00



07225-00

Amputationsmesser
Amputation Knives
Cuchillos para amputación
Cotelli per amputazione

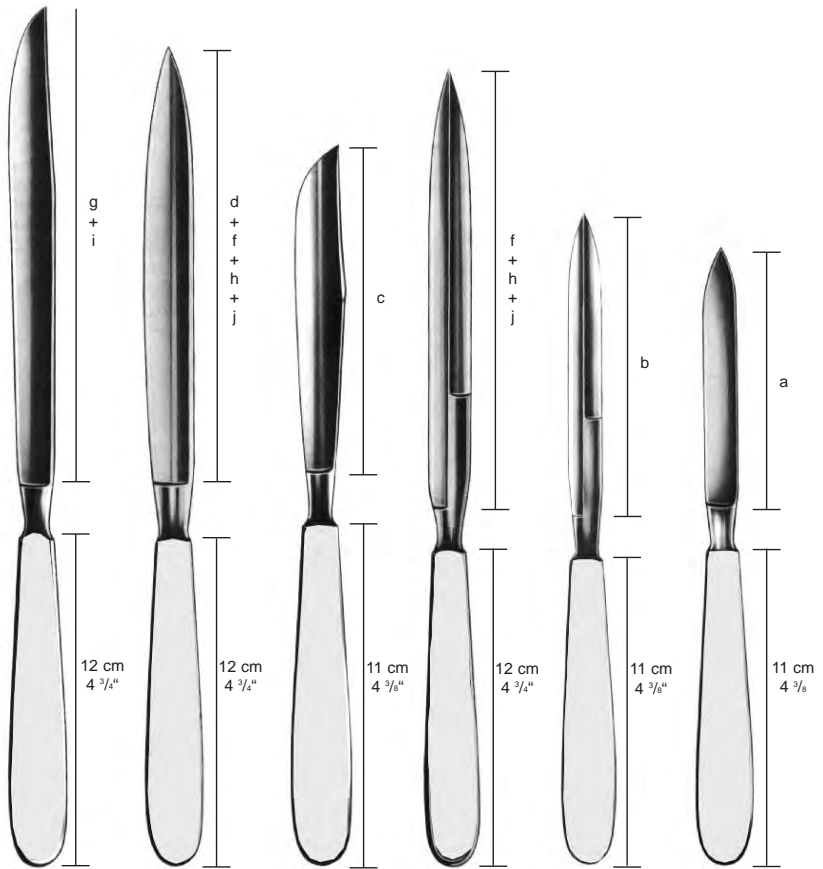

Liston
07200-17
07200-20

Reda
07201-13
07201-16
07201-19
07201-22

Langenbeck
07202-12

Catlin
doppelschneidig
double
aftingedeges
filo doble
doppio taglio
07203-16
07203-19
07203-22

07204-11

Zwischenknochen-
messer doppel-
schneidig
Inerosseous knife
double aftingedeges
Cuchillo interóseo
filo doble
Cottello interosseo
doppio taglio

07205-09

Phalangen-
messer
Phalangeal knife
Cuchillos para
falanges
Cottello per falangi

Schnittlänge
Length of blades
Largo de hojas
Lunghezze delle lame

a - 9,5 cm	c - 12,0 cm	e - 15,0 cm	g - 17,0 cm	i - 20,0 cm
b - 11,0 cm	d - 13,0 cm	f - 16,0 cm	h - 19,0 cm	j - 22,0 cm
a - 3 3/4"	c - 4 3/4"	e - 6"	g - 6 3/4"	i - 8"
b - 4 3/8"	d - 5"	f - 6 1/4"	h - 7 1/2"	j - 8 3/4"

Klingenbrecher, Rasierklingen
 Blade Breakers, Razor Blades
 Rompe-hojas, hojas de afeitarse
 Lama di rasoio, Rompilamette



TROUTMAN-CHRIS
 07290-09 9 cm, 3 1/2"



REDA
 07291-11 11 cm, 4 3/8"



CASTROVIEJO
 07294-13 13 cm, 5 1/8"



07296-00

Packung = 10 Stück
 package = 10 each
 caja = 10 c/u
 confezione = 10 pezzi

Skalpelle mit Metallheft
 Scalpels with Metal Handle
 Bisturías, mango metálico
 Bisturi, manico di metallo



Fig. 1
 07402-01
 15 cm, 6"
 30 mm, 1.2"



Fig. 2
 07402-02
 15 cm, 6"
 36 mm, 1.4"



Fig. 3
 07402-03
 15.5 cm, 6"
 40 mm, 1 1/2"



Fig. 4
 07402-04
 16 cm, 6 1/4"
 45 mm, 1 3/4"



Fig. 5
 07402-05
 16 cm, 6 1/4"
 50 mm, 2"



Fig. 6
 07402-06
 15 cm, 6"
 27 mm, 1"



Fig. 7
 07402-07
 15 cm, 6"
 35 mm, 1.4"



Fig. 8
 07402-08
 16 cm, 6 1/4"
 40 mm, 1 1/2"



Fig. 9
 07402-09
 16 cm, 6 1/4"
 47 mm, 1.9"



Fig. 10
 07402-10
 17 cm, 6 3/4"
 50 mm, 2"

Resektions- und Knorpelmesser
 Resection and Cartilage Knives
 Cuchillos para resección/cartilagos
 Coltelli per resezione e cartilagini



19 cm, 7 1/2"

07403-01

Metallheft
 metal handle
 mango metálico
 manico di metallo



19 cm, 7 1/2"

07403-02

Holzheft
 wooden handle
 mango de madera
 manico in legno



18 cm, 7"

07410-05
 Langenbeck

07412-05

Sezier-, Hirn- und Organmesser
 Autopsy- Brain- and Post mortem knives
 Cuchillos para autopsia- cerebro- órganos
 Coltelli per cartilagini- cervello e organi

Schnittlänge
 Length of blades
 Largo de hojas
 Lunghezze delle lame

- a - 8,5 cm, 3.4"
- b - 9,5 cm, 3 3/4"
- c - 11,0 cm, 4 1/8"
- d - 14,0 cm, 5 1/2"
- e - 16,0 cm, 6 1/4"
- f - 17,0 cm, 6 3/4"
- g - 19,5 cm, 7 3/4"
- h - 20,0 cm, 8"
- i - 24,0 cm, 9 1/2"

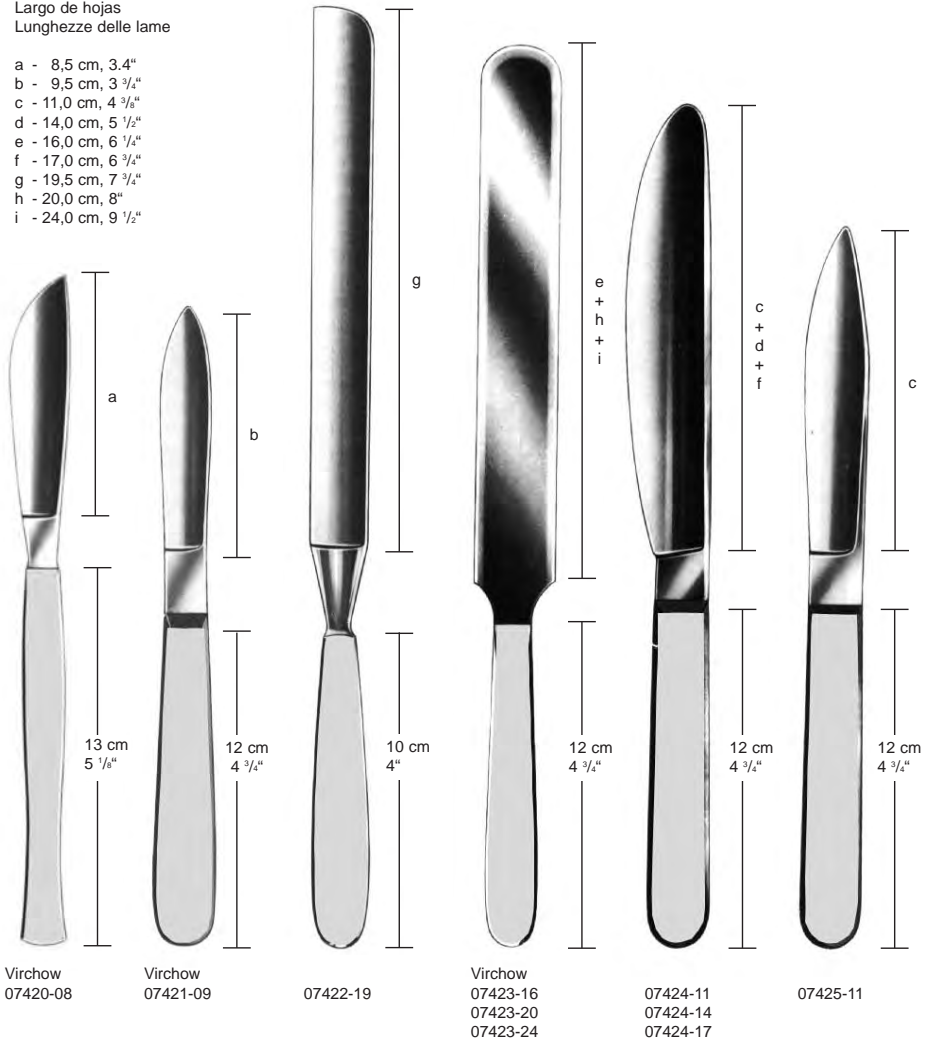

Dermatome, Rasiermesser
 Dermatome, Razor
 Dermátomo, Navajas
 Dermatomo, Rasoio



SCHINK
 07490-00
 30 cm, 11 3/4"
 0,1 - 2 mm
 compl.
 mit/with/con
 07490-01 (1) Stk./ pcs/ pzas
 07490-02 (2) Stk./ pcs/ pzas



07490-01
 Ersatzklinge
 Spare blade
 Hoja de repuesto
 Lama di ricambio per dermatomo

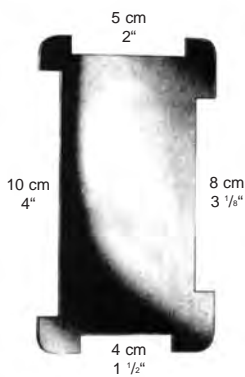

07490-02
 Spannplatte
 Skin straightening plate
 Placa para extender la piel
 Placca per stendipelle



07496-00
 Rasiermesser 8 cm, 3 1/8"
 Razors 8 cm, 3 1/8"
 Navajas 8 cm, 3 1/8"
 Rasoio 8 cm, 3 1/8"

Dermatome
 Dermatome
 Dermátomo
 Dermatomo

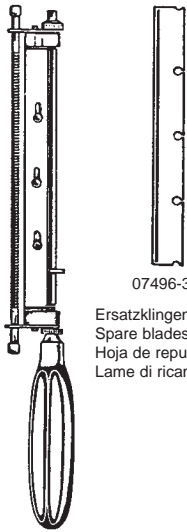

07496-31

Ersatzklingen
 Spare blades pack
 Hoja de repuesto
 Lame di ricambio

HUMBY
 07495-31 31 cm, 12 1/4"
 0,1 - 1,2 mm



SILVER
 07498-00
 190 mm, 7 1/2"
 Dermatome, ohne Klengen
 Skin graft knife, without blade
 Dermátomo sin hoja
 Senza lama utilizzo con lamette
 da barba normale



Klingen
 blades
 bisturi
 07499-01

WATSON
 07499-00
 300 mm, 11 3/4"
 Dermatome, ohne Klengen
 Skin graft knife, without blade
 Dermátomo sin hoja
 Senza lama utilizzo con lamette
 da barba normale

Chirurgische Scheren
Operating Scissors
Tijeras para cirugía
Forbici per chirurgia



STANDARD

09102-11 11,5 cm, 4 1/2"
09102-13 13,0 cm, 5"
09102-14 14,5 cm, 5 3/4"
09104-14 TC
09102-15 15,5 cm, 6"
09102-16 16,5 cm, 6 1/2"
09102-18 18,5 cm, 7 1/4"
09102-20 20,0 cm, 8"



STANDARD

09110-11 11,5 cm, 4 1/2"
09110-13 13,0 cm, 5"
09110-14 14,5 cm, 5 3/4"
09114-14 TC
09110-15 15,5 cm, 6"
09110-16 16,5 cm, 6 1/2"
09110-18 18,5 cm, 7 1/4"
09110-20 20,0 cm, 8"



STANDARD

09120-11 11,5 cm, 4 1/2"
09120-13 13,0 cm, 5"
09120-14 14,5 cm, 5 3/4"
09124-14 TC
09120-15 15,5 cm, 6"
09120-16 16,5 cm, 6 1/2"
09120-18 18,5 cm, 7 1/4"
09120-20 20,0 cm, 8"



STANDARD

09103-11 11,5 cm, 4 1/2"
09103-13 13,0 cm, 5"
09103-14 14,5 cm, 5 3/4"
09105-14 TC
09103-15 15,5 cm, 6"
09103-16 16,5 cm, 6 1/2"
09103-18 18,5 cm, 7 1/4"
09103-20 20,0 cm, 8"



STANDARD

09111-11 11,5 cm, 4 1/2"
09111-13 13,0 cm, 5"
09111-14 14,5 cm, 5 3/4"
09115-14 TC
09111-15 15,5 cm, 6"
09111-16 16,5 cm, 6 1/2"
09111-18 18,5 cm, 7 1/4"
09111-20 20,0 cm, 8"



STANDARD

09121-11 11,5 cm, 4 1/2"
09121-13 13,0 cm, 5"
09121-14 14,5 cm, 5 3/4"
09125-14 TC
09121-15 15,5 cm, 6"
09121-16 16,5 cm, 6 1/2"
09121-18 18,5 cm, 7 1/4"
09121-20 20,0 cm, 8"

Präparierscheren
 Dissecting Scissors
 Tijeras de disección
 Forbici per dissezione

Inzisionschere – Incision Scissors – Tijera de incision – Forbici per incisione



09128-14
 14,0 cm
 5 1/2"

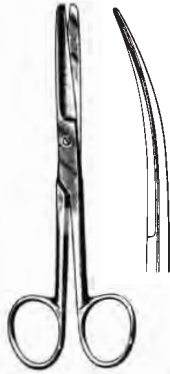

DEAVER
 09130-14 14 cm 09131-14
 5 1/2"

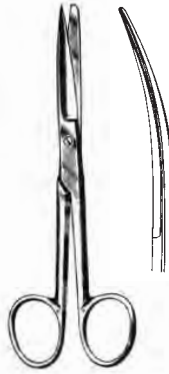

DEAVER
 09140-14 14 cm 09141-14
 5 1/2"

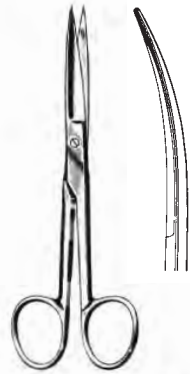

DEAVER
 09150-14 14 cm 09151-14
 5 1/2"



MAYO
 09160-14 14,5 cm 09161-14
 09164-14 TC 14,5 cm 09165-14 TC
 5 3/4"



MAYO-STILLÉ
 09170-15 15,0 cm 09171-15
 09174-15 TC 15,0 cm 09175-15 TC
 6"



MAYO-NOBLE
 09180-17 17,0 cm 09181-17
 6 3/4"

09160-17 17,0 cm 09161-17
 09164-17 TC 17,0 cm 09165-17 TC
 6 3/4"
 09160-23 23,0 cm 09161-23
 09164-23 TC 23,0 cm 09165-23 TC
 9"

09170-17 17,0 cm 09171-17
 09174-17 TC 17,0 cm 09175-17 TC
 6 3/4"
 09170-21 21,0 cm 09171-21
 09174-21 TC 21,0 cm 09175-21 TC
 8 1/2"

Präparierscheren
Dissecting Scissors
Tijeras de disección
Forbici per dissezione



LEXER
09190-16
09194-16 TC
16 cm, 6 1/4"



LEXER
09191-16
09195-16 TC
16 cm, 6 1/4"



LEXER BABY
09202-10 09203-10
09206-10 TC 09207-10 TC
10 cm, 4"



JORGENSEN
09204-22
22 cm, 8 3/4"

Präparierscheren
Dissecting Scissors
Tijeras de disección
Forbici per dissezione



METZENBAUM
09280-12 09284-12 TC
12 cm 4 3/4"
09280-15 09284-15 TC
15 cm 6"
09280-18 09284-18 TC
18 cm 7"
09280-20 09284-20 TC
20 cm 8"
09280-23 09284-23 TC
23 cm 9"
09280-25 09284-25 TC
25 cm 10"
09280-28 09284-28 TC
28 cm 11"
09280-30 09284-30 TC
30 cm 12"



METZENBAUM
09281-12 09285-12 TC
12 cm 4 3/4"
09281-15 09285-15 TC
15 cm 6"
09281-18 09285-18 TC
18 cm 7"
09281-20 09285-20 TC
20 cm 8"
09281-23 09285-23 TC
23 cm 9"
09281-25 09285-25 TC
25 cm 10"
09281-28 09285-28 TC
28 cm 11"
09281-30 09285-30 TC
30 cm 12"



METZENBAUM FINO
09282-15 09286-15 TC
15 cm 6"
09282-18 09286-18 TC
18 cm 7"
09282-20 09286-20 TC
20 cm 8"
09282-23 09286-23 TC
23 cm 9"
09282-25 09286-25 TC
25 cm 10"
09282-28 09286-28 TC
28 cm 11"



METZENBAUM FINO
09283-15 09287-15 TC
15 cm 6"
09283-18 09287-18 TC
18 cm 7"
09283-20 09287-20 TC
20 cm 8"
09283-23 09287-23 TC
23 cm 9"
09283-25 09287-25 TC
25 cm 10"
09283-28 09287-28 TC
28 cm 11"

Präparierschere / Kapselschere
Dissecting Scissors / Capsula Scissor
Tijeras de disección / Tijera p. cápsula
Forbici per dissezione / Forbici per capsula

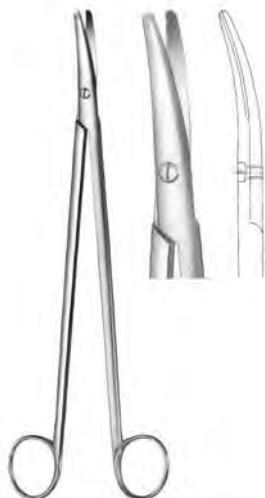

WELLER
09289-28
28 cm, 11"



RESANO
09290-25
25 cm, 10"

Chirurgische Scheren, fein
 Operating Scissors, fine
 Tijeras para cirugía, finas
 Forbici per chirurgia, fine



METZENBAUM "S"

09291-18 18 cm, 7" 09295-18 TC
 09291-20 20 cm, 8" 09295-20 TC
 09291-23 23 cm, 9" 09295-23 TC

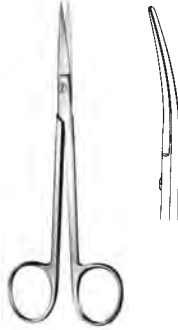

SANVENERO

09302-14 14 cm 09303-14
 5 1/2"

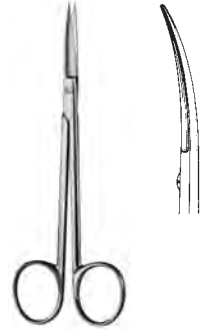

JOSEPH

09304-14 14 cm 09305-14
 5 1/2"

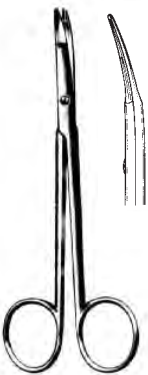

KILNER

09310-12 12 cm 09314-12 TC
 09310-15 15 cm
 09312-12 12 cm gerade/straight/recta/retta

9 cm 3 1/2"
 10 cm 4"
 11 cm 4 3/8"
 12 cm 4 3/4"
 15 cm 6"



REYNOLDS

09320-15 15 cm 09321-15
 09321-18
 09325-15 TC

Iris - Standard

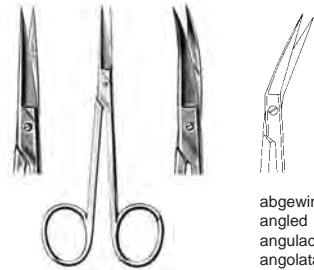

abgewinkelt
 angled
 angulada
 angolata

09340-09 9 cm 09341-09 09346-11 11 cm
 09340-10 10 cm 09341-10
 09340-11 11 cm 09341-11
 09344-11 TC 09345-11 TC

Chirurgische Scheren, fein
 Operating Scissors, fine
 Tijeras para cirugía, finas
 Forbici per chirurgia, fine

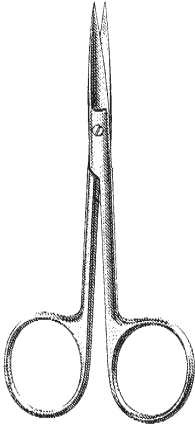

— KNAPP
 10 cm, 4" —
 09348-01 09348-02

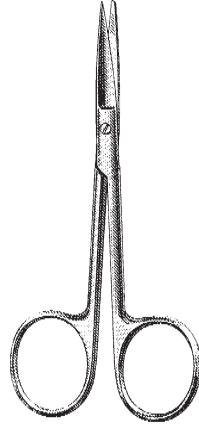

— KNAPP
 10 cm, 4" —
 09348-03 09348-04

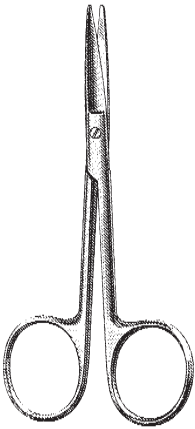

— KNAPP
 10 cm, 4" —
 09348-05 09348-06



LITTLER
 12 cm, 4 3/4"
 09349-12

Präparierscheren, feines Modell
Dissecting Scissors, fine pattern
Tijeras de disección, finas
Forbici per preparazione, modello fino



GRAEFE
09350-10
100 mm
4"



COTTLE
09358-11
115 mm
4 1/2"

Scheren, Ophthalmologie
 Scissors, Ophthalmology
 Tijeras, oftalmologia
 Forbici, per oftalmologia



GRADLE

09350-09 09351-09
 9,5 cm, 3 3/4"

gerade	gebogen
straight	curved
rectas	curvas
retta	curva



09352-09 09353-09
 9,5 cm, 3 3/4"

gerade	gebogen
straight	curved
rectas	curvas
retta	curva



09354-10 09355-10
 10 cm, 4"

gerade	gebogen
straight	curved
rectas	curvas
retta	curva



09356-10 09357-10
 10 cm, 4"

gerade	gebogen
straight	curved
rectas	curvas
retta	curva

Scheren, Ophthal, Nase
 Scissors, Ophthal, Nasal
 Tijeras, oftalmología, nasales
 Forbici, oftalmologia, nasali

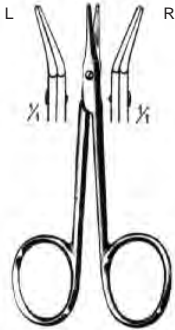

AEBLI
 09347-09 9 cm 09349-09
 3 1/2"



STEVENS
 11 cm
 4 3/8"



09360-11 09361-11
 09362-11 09363-11



ENUCLEATION
 09381-11
 13 cm, 5 1/8"



STRABISMUS
 09370-11 09371-11
 09374-11 TC, 09375-11 TC
 11 cm, 4 3/8"



HEYMANN
 09401-18
 18 cm, 7"



FOMON
 09403-15
 15 cm, 6"

Tonsillen-, Gefäßscheren
 Tonsil, Vascular Scissors
 Tijeras, amígdalas y vasculares
 Forbici per tonsilli e vascolari



COTTLE
 09405-16
09406-16 TC
 16 cm, 6 1/4"



DEAN
 09425-17 09427-17
 17 cm, 6 3/4"



BOETTCHER
 09435-18
 18 cm, 7"



GOOD
 09437-19
 19 cm, 7 1/2"

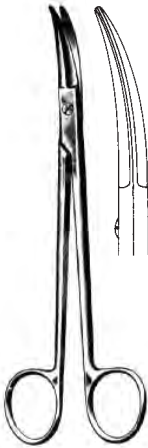

PRINCE
 09439-17
 17 cm, 6 3/4"



09468-15
 15 cm, 6"



09470-11
 11 cm, 4 3/8"

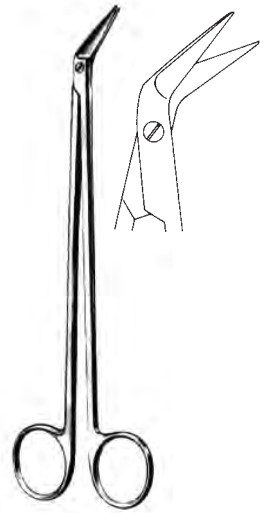

POTTS-DE MARTEL
 09473-21
 21 cm, 8 1/2"

Scheren, Thorax und Gefäße
 Scissors, thorax and vascular
 Tijeras, torácicas y vasculares
 Forbici vascolari e toraciche



DIETRICH
 09475-25 – 09475-00
 17 cm, 6 3/4"



09475-25
09476-25 TC
 18 cm, 7"



09475-45
09476-45 TC
 18 cm, 7"



09475-60
09476-60 TC
 17,5 cm, 6.9"



09475-90
09476-90 TC
 17 cm, 6 3/4"



09475-00
09476-00 TC
 17 cm, 6 3/4"

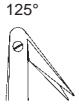

DIETRICH
 09477-01
 17 cm, 6 3/4"



De Bakey
 (Potts-Smith)

Scheren mit Hartmetalleinsätzen
 Scissors with Tungsten Carbide
 Tijeras con carburo de tungsteno
 Forbici con carburo di tungsteno

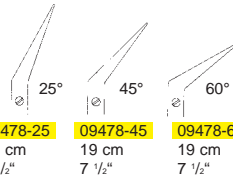

09478-25 19 cm 7 1/2"
09478-45 19 cm 7 1/2"
09478-60 19 cm 7 1/2"

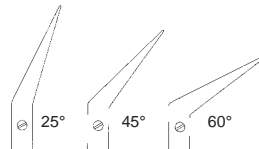

09479-25 23 cm 9"
09479-45 23 cm 9"
09479-60 23 cm 9"

Gefäßscheren
Vascular Scissors
Tijeras vasculares
Forbici vascolari

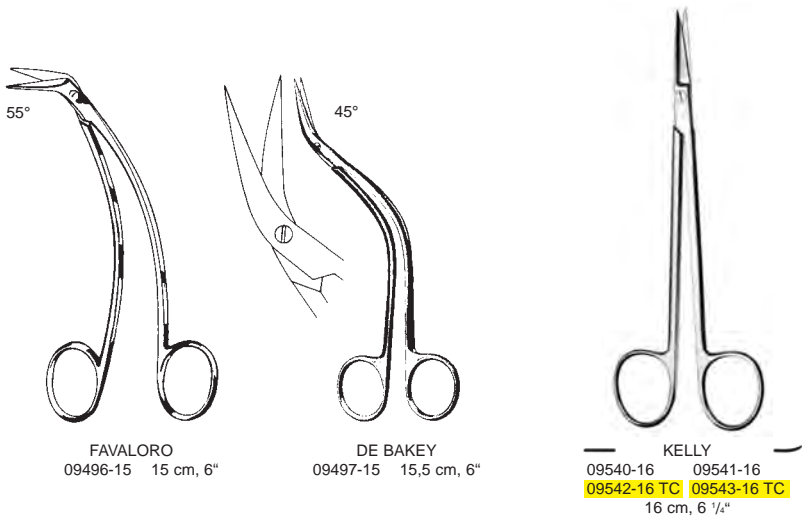
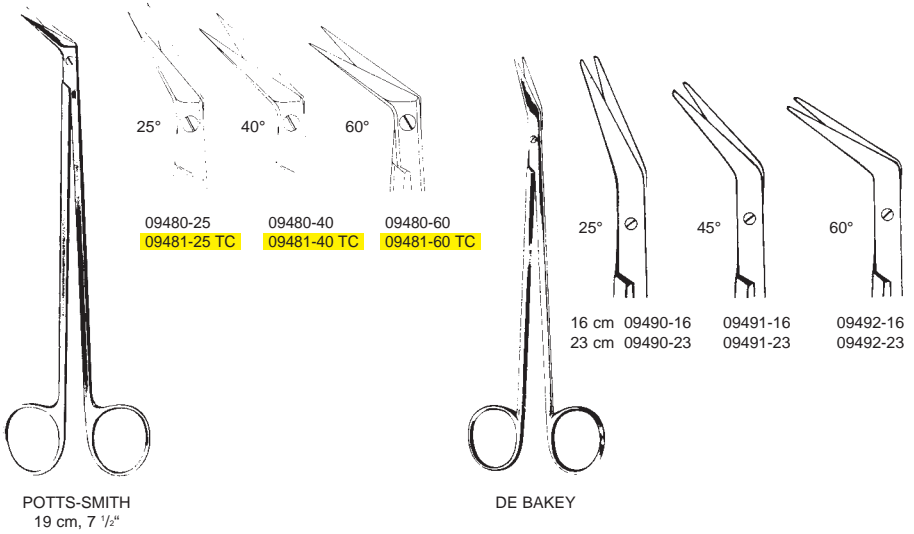

Gynäkologische Scheren
 Gynecological Scissors
 Tijeras ginecológicas
 Forbici ginecologiche



SIMS

09510-20 20 cm, 8" 09511-20
 09510-23 23 cm, 9" 09511-23

09516-23 TC 23 cm, 9" 09517-23 TC



09512-20
 09512-23



09513-20
 09513-23



09514-20
 09514-23



09515-20
 09515-23

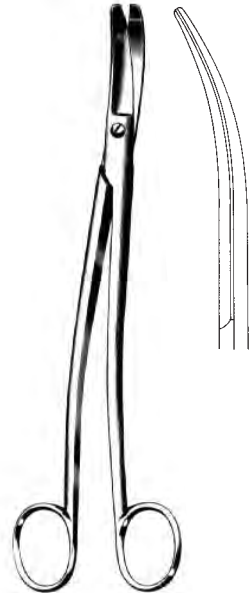

SIEBOLD

09523-24 24 cm, 9 1/2"

Gynäkologische Scheren
 Gynecological Scissors
 Tijeras ginecológicas
 Forbici ginecologiche

Parametrium



09501-22 22,5 cm, 8.9"
 09505-22 TC 22,5 cm, 8.9"

09501-23 23 cm, 9"
 09505-23 TC 23 cm, 9"



WERTHEIM
 09525-22 22,5 cm, 8.9"



DOYEN
 09530-17 09531-17
 17,5 cm, 6.9"



DUBOIS
 09536-27 09537-27
 27 cm, 10 1/2"

Chirurgische Scheren
 Operating Scissors
 Tijeras para cirugía
 Forbici per chirurgia



gezahnt
 saw edge
 dentadas
 dentellata

WALDMANN
 09548-18
 18 cm, 7"



U.S.A. Mod.
 09550-10
 10,5 cm, 4"



BUSCH
 09551-16
 16 cm, 6 1/4"



SCHUMACHER
 09553-16
 16 cm, 6 1/4"



BRAUN-STADLER
 09560-14 14,5 cm, 5 3/4"
 09560-22 22,0 cm, 8 1/2"

Chirurgische Scheren
 Operating Scissors
 Tijeras para cirugía
 Forbici per chirurgia

Neurochirurgie - Neurosurgery - Neurocirugía - Neurochirurgia



09580-11 09581-11
 11 cm, 4 3/8"



09582-15 09583-15
 15 cm, 6"

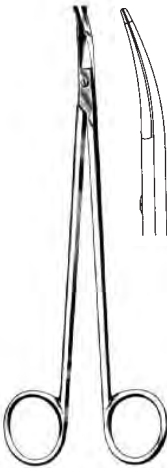

STRULLY
 09601-22
 22 cm, 8 7/8"



TOENNIS-ADSON
 09610-18
 18 cm, 7"



TOENNIS-ADSON
 09611-18
 18 cm, 7"

Chirurgische Scheren
Operating Scissors
Tijeras para cirugía
Forbici per chirurgia



gezahnt
saw edge
dentadas
dentellata

MARTIN CARTILAGE
09613-20
20 cm, 8"



McINDOE
09614-19
19 cm, 7 1/2"



FOMON
09617-13
13 cm, 5 1/8"



SCHMIEDEN-TAYLOR
09619-17
17 cm, 6 3/4"

Chirurgische Scheren
 Operating Scissors
 Tijeras para cirugía
 Forbici per chirurgia



CRAFOORD
 09641-30
 30 cm, 11 3/4"



THOREK
 09643-19 19 cm, 7 1/2"
 09643-25 25 cm, 10"

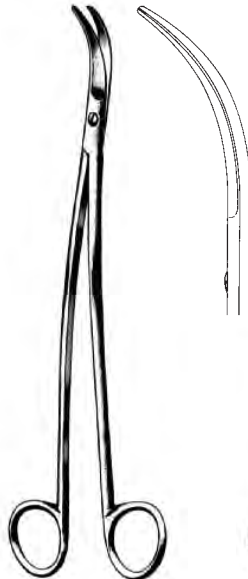

SATINSKY
 09651-24
 24,5 cm, 9 1/2"

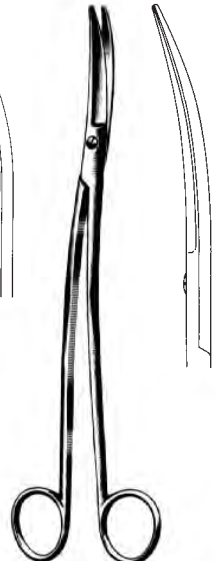

KLINKENBERGH-LOTH
 09661-23
 23 cm, 9"

Chirurgische Scheren
 Operating Scissors
 Tijeras para cirugía
 Forbici per chirurgia

Darmscheren
 Enterotomy Scissors
 Enterótomos
 Forbici per enterotomia



FERGUSSON
 09770-18
 18 cm, 7"



09772-21
 21 cm, 8 1/4"



09774-21
 21 cm, 8 1/4"



— SYSTRUNK —
 09775-13 09777-13
 13 cm, 5 1/8"

Ligaturscheren, Fadenscheren
 Ligature Scissors
 Tijeras para ligaduras
 Forbici per legature



SPENCER
 09802-09
 9 cm, 3 1/2"



SPENCER
 09802-11
 11 cm, 4 3/8"



NORTHBENT
 09803-09 9 cm, 3 1/2"
 09803-13 13 cm, 5 1/8"



LITTAUER
 09804-14
 14 cm, 5 1/2"



HEATH
 09809-15
 15 cm, 6"

Chirurgische Scheren
 Operating Scissors
 Tijeras para cirugía
 Forbici per chirurgia

Zahnfleischscheren
 Gum Scissors
 Tijeras para encías
 Forbici gengivali

- 1 Schneide gezahnt
 1 blade toothed
 1 hoja dentada
 1 taglio della lama dentellato



— GOLDMAN-FOX —
 09820-13 13 cm, 5 1/8" 09821-13

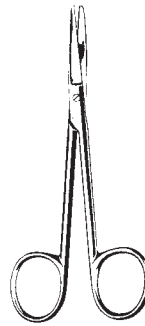

WAGNER
 12 cm, 4 3/4"

gerade
 straight
 rectas
 rette



Fig. 1
 09828-12



Fig. 2
 09826-12



Fig. 3
 09824-12

gebogen
 curved
 curvas
 curve



Fig. 1
 09823-12



Fig. 2
 09829-12



Fig. 3
 09825-12

Draht-, Blechscherer
 Wire and plate shears
 Tijeras para alambre y láminas
 Forbici per filo di metallo e lamiera



QUINBY
 09827-12 12 cm, 4 3/4"



UNIVERSAL
 09831-12 12 cm, 4 3/4"
 09835-12 TC 12 cm, 4 3/4"

Beebe Kronenscheren
 Beebe Crown Scissors
 Beebe Tijeras para coronas
 Beebe Forbici per corona



Beebe

09850-10
 gerade 10,5 cm (4") spitz
 straight 10,5 cm (4") pointed
 rectas 10,5 cm (4") agudas
 rette 10,5 cm (4") acute

09852-10
 gerade 10,5 cm (4") stumpf
 straight 10,5 cm (4") blunt
 rectas 10,5 cm (4") romas
 rette 10,5 cm (4") smusse

09851-10
 gebogen 10,5 cm (4") spitz
 curved 10,5 cm (4") pointed
 curvas 10,5 cm (4") agudas
 curve 10,5 cm (4") acute

09853-10
 gebogen 10,5 cm (4") stumpf
 curved 10,5 cm (4") blunt
 curvas 10,5 cm (4") romas
 curve 10,5 cm (4") smusse

Zahnfleischscheren
 Gum Scissors
 Tijeras para encias
 Forbici gengivali



LA Grange
 09854-11
 11,5 cm, 4 1/2"



gezahnt
 saw edge
 dentadas
 dentellata

LOCKLIN
 09859-16
 16 cm, 6 1/2"



gezahnt
 saw edge
 dentadas
 dentellata

LOCKLIN
 09860-16
 16,5 cm, 6 1/2"



LOCKLIN
09861-16 TC
 16,5 cm, 6 1/2"

Verbandscheren
 Bandage Scissors
 Tijeras para vendajes
 Forbici per bendaggi

Gaze
 Gauze
 Gaza
 Garza



SMITH US ARMY
 09898-20
 20 cm, 8"



LISTER
 9 cm, 3 1/2" 09901-09
 11 cm, 4 3/8" 09901-11
 14 cm, 5 1/2" 09901-14
 18 cm, 7" 09901-18
 20 cm, 8" 09901-20

09905-14 TC
 09905-18 TC



LISTER
 09906-18 18 cm, 7"
 09906-20 20 cm, 8"



BERGMANN
 09911-23
 23 cm, 9"

Verbandscheren
Bandage Scissors
Tijeras para vendajes
Forbici per bendaggi



ESMARCH
09913-20 20 cm, 8"
09913-22 22 cm, 8 3/4"



SEUTIN
09915-23
23 cm, 9"



REDA EXCENTER
09921-16 16 cm, 6 1/4"
09921-19 19 cm, 7 1/2"



gezahnt
toothed
dentadas
dentellata

Verbandscheren
 Bandage Scissors
 Tijeras para vendajes
 Forbici per bendaggi



KNOWLES
 09930-14
 14 cm, 5 1/2"



KNOWLES
 09931-14
 14 cm, 5 1/2"



LORENZ
 09933-23
 23 cm, 9"



BRUNS
 09935-23 23 cm, 9"
 09937-23 23 cm, 9"
09939-23 TC

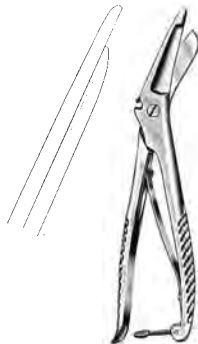

09941-20
 20 cm, 8"

in verschiedenen Farben lieferbar
 in different colours available
 en diferentes colores disponibles
 in differenti colori disponibile



UNIVERSAL
 09950-15 15 cm, 6"
 09950-18 18 cm, 7"

Supercut Scheren
Supercut Scissors
Tijeras Supercut
Forbici Supercut



gezahnt
saw edge
dentadas
dentellate

09960-14 09961-14
14,5 cm, 5 3/4"
gerade gebogen
straight curved
rectas curvas
rette curve



gezahnt
saw edge
dentadas
dentellate

MAYO
09962-14 14,5 cm 09963-14
09962-17 17,0 cm 09963-17
09962-23 23,0 cm 09963-23
gerade gebogen
straight curved
rectas curvas
rette curve



gezahnt
saw edge
dentadas
dentellate

MAYO-STILLE
09964-15 15,0 cm 09965-15
09964-17 17,0 cm 09965-17
gerade gebogen
straight curved
rectas curvas
rette curve



gezahnt
saw edge
dentadas
dentellate

BABY METZENBAUM
09966-11 09967-11
11,5 cm, 4 1/2"
gerade gebogen
straight curved
rectas curvas
rette curve



gezahnt
saw edge
dentadas
dentellate

METZENBAUM
09970-14 14,5 cm 09971-14
09970-18 18,0 cm 09971-18
09970-20 20,0 cm 09971-20
09970-23 23,0 cm 09971-23
gerade gebogen
straight curved
rectas curvas
rette curve

Supercut Scheren
 Supercut Scissors
 Tijeras Supercut
 Forbici Supercut



gezahnt
 saw edge
 dentadas
 dentellate

IRIS
 09980-11 09981-11
 11,5 cm, 4 1/2"
 gerade gebogen
 straight curved
 rectas curvas
 rette curve



gezahnt
 saw edge
 dentadas
 dentellate

WAGNER
 09982-12 09983-12
 12 cm, 4 3/4"
 gerade gebogen
 straight curved
 rectas curvas
 rette curve



STEVENS
 09984-11 09985-11
 11,5 cm, 4 1/2"
 gerade gebogen
 straight curved
 rectas curvas
 rette curve



gezahnt
 saw edge
 dentadas
 dentellate

LaGrange
 09986-11 11,5 cm, 4 1/2"



gezahnt
 saw edge
 dentadas
 dentellate

LISTER
 09990-14 14,5 cm, 5 3/4"
 09990-18 18,0 cm, 7"



REYNOLDS
 09993-15 15 cm, 6"
 09993-18 18 cm, 7"



KILNER/RAGNELL
 09995-12 12 cm, 4 3/4"

Face Lift Scheren
 Face Lift Scissors
 Tijeras Face Lift
 Forbici Face Lift



GORNEY FACE LIFT
 19 cm, 7 1/2"

10010-19
 10012-19 TC
 10014-19 Supercut



10011-19
 10013-19 TC
 10015-19 Supercut



REES FACE LIFT

10016-17 — 17,0 cm, 6 3/4"
 10017-17 — 17,0 cm, 6 3/4"
 10018-20 — 20,5 cm, 8"
 10019-20 — 20,5 cm, 8"

TC
 10020-17 — 17,0 cm, 6 3/4"
 10021-17 — 17,0 cm, 6 3/4"
 10022-20 — 20,5 cm, 8"
 10023-20 — 20,5 cm, 8"

Supercut
 10024-17 — 17,0 cm, 6 3/4"
 10025-17 — 17,0 cm, 6 3/4"
 10026-20 — 20,5 cm, 8"
 10027-20 — 20,5 cm, 8"



KAYE FACE LIFT

TC
 10028-14 — 14,5 cm, 5 3/4"
 10029-14 — 14,5 cm, 5 3/4"
 10030-18 — 18,5 cm, 7 1/4"
 10031-18 — 18,5 cm, 7 1/4"
 10032-23 — 23,0 cm, 9"
 10033-23 — 23,0 cm, 9"

Supercut
 10034-14 — 14,5 cm, 5 3/4"
 10035-14 — 14,5 cm, 5 3/4"
 10036-18 — 18,5 cm, 7 1/4"
 10037-18 — 18,5 cm, 7 1/4"
 10038-23 — 23,0 cm, 9"
 10039-23 — 23,0 cm, 9"

Face Lift Scheren
 Face Lift Scissors
 Tijeras Face Lift
 Forbici Face Lift



FREEMAN FACE LIFT

- 10040-18 — 18 cm, 7"
- 10041-18 TC — 18 cm, 7"
- 10042-18 Supercut — 18 cm, 7"



PECK JOSEPH

- 10044-14 — 14,5 cm, 5 3/4"
- 10045-14 — 14,5 cm, 5 3/4"
- 10046-14 TC — 14,5 cm, 5 3/4"
- 10047-14 TC — 14,5 cm, 5 3/4"
- 10048-14 Supercut — 14,5 cm, 5 3/4"
- 10049-14 Supercut — 14,5 cm, 5 3/4"

Augenscheren
Ophthalmic Scissors
Tijeras oculares
Forbici oculistiche



WESTCOTT
10102-11
11 cm, 4 3/8"



WESTCOTT
10104-11
11 cm, 4 3/8"



NOYES
10110-12 10111-12
12 cm, 4 3/4"



WECKER
11 cm, 4 3/8"



10113-11



10115-11



10117-11



BARRAQUER
10119-10 5,5 cm, 2.2"
(Colibri)

Mikro-Scheren
 Micro-Scissors
 Micro-Tijeras
 Micro-Forbici



10120-16
 10120-18
 10120-22

16,0 cm, 6 1/4"
 18,5 cm, 7 1/4"
 22,5 cm, 8,9"



10121-16
 10121-18
 10121-22



10122-16
 10122-18
 10122-22

16,0 cm, 6 1/4"
 18,5 cm, 7 1/4"
 22,5 cm, 8,9"



10123-16
 10123-18
 10123-22



10124-16
 10124-18
 10124-22

16,0 cm, 6 1/4"
 18,5 cm, 7 1/4"
 22,5 cm, 8,9"



10125-16
 10125-18
 10125-22

Circumflex

Mikro-Scheren
Micro-Scissors
Micro-Tijeras
Micro-Forbici



25°

10126-25



45°

10126-45

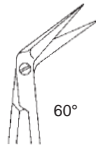

60°

10126-60

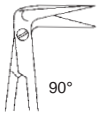

90°

10126-90



125°

10126-00



Reda
18 cm, 7"



25°

10127-25



45°

10127-45

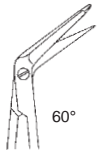

60°

10127-60

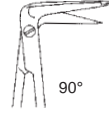

90°

10127-90



125°

10127-00

Mikro-Scheren
 Micro-Scissors
 Micro-Tijeras
 Micro-Forbici



10128-09
 9 cm, 3 1/2"



10128-15 15 cm, 6"
 gerade
 straight
 rectas
 rette

10129-15 15 cm, 6"
 gebogen
 curved
 curvas
 curvo

10130-15 15 cm, 6"
 gebogen, 1 Schneide gezahnt
 curved, 1 blade toothed
 curvas, 1 hoja dentada
 curva, 1 lama dentellata

10128-15 - 10130-15
 15 cm, 6"

halbscharf
 semi-sharp
 medio roma
 lame semi smusse



Hepp-Scheidel
 10131-14 14 cm, 5 1/2"
 10131-16 16 cm, 6 1/4"



Hepp-Scheidel
 10132-18
 18 cm, 7"



Hepp-Scheidel 10137-01 18 cm, 7" spitz pointed agudas acute	Hepp-Scheidel 10137-02 18 cm, 7" stumpf blunt romas smusse
---	--

Augen-, Mikroscheren
 Ophthalmic, Micro Scissors
 Tijeras oculares, micro tijeras
 Forbici oculistiche, micro chirurg.

Iridektomie, Iridectomy, Iridectomia, iridectomia



CASTROVIEJO
 10133-10 10 cm, 4°

CASTROVIEJO
 10135-10 10 cm, 4°



VANNAS
 10140-08 8 cm, 3 1/8°



VANNAS
 10141-08 8 cm, 3 1/8°

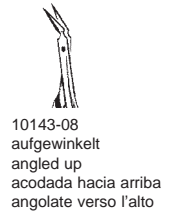

Hornhautscheren, Corneal scissors, Tijeras corneales, Forbici corneali



CASTROVIEJO
 10151-11 11 cm, 4 3/8°



CASTROVIEJO
 10153-11 11 cm, 4 3/8°



CASTROVIEJO
 10155-11 11 cm, 4 3/8°

Mikro-Scheren
Micro-Scissors
Micro-Tijeras
Micro-Forbici



Reda
10202-18 - 10203-18
18 cm, 7"



GOMEL



10313-14
14 cm
5 1/2"



10313-16
16 cm
6 1/4"



Reda micro
10320-09
9 cm, 3 1/2"



Reda
10330-19 - 10333-19
18,5 cm, 7 1/4"



10330-19



10331-19



10333-19

Anatomische und chirurgische Pinzetten
 Dressing and Tissue Forceps
 Pinzas de disección, sin/con dientes
 Pinze per dissezione, chirurgiche/anatomiche

STANDARD



cm		11102-10		USA	STILLE
10,5	4 1/4"	11102-11			
11,5	4 1/2"			11104-12	
12,0	4 3/4"	11102-13		11104-13	11106-13
13,0	5 1/8"	11102-14	11103-14	11104-14	
14,5	5 3/4"				11106-15
15,0	6"			11104-15	
15,5	6"	11102-16			
16,0	6 1/2"	11102-18		11104-18	
18,0	7"	11102-20			
20,0	8"			11104-21	
21,0	8 1/4"	11102-25		11104-25	
25,0	10"	11102-30			
30,0	12"				



cm				POTTS-SMITH	POTTS-SMITH 1x2
10,5	4 1/4"				
11,5	4 1/2"	11110-11			
12,0	4 3/4"				
13,0	5 1/8"	11110-13			
14,5	5 3/4"	11110-14	11114-14 TC		
15,0	6"				
15,5	6"				
16,0	6 1/4"	11110-16	11114-16 TC		
18,0	7"	11110-18		11112-18	11116-18 TC
20,0	8"	11110-20	11114-20 TC		11126-18
21,0	8 1/4"			11112-21	11116-21 TC
25,0	10"	11110-25	11114-25 TC	11112-25	11116-25 TC
30,0	12"	11110-30			11126-25

Chirurgische Pinzetten
 Tissue Forceps
 Pinzas de disección, con dientes
 Pinze per dissezione, chirurgiche

STANDARD



1x2



USA



STILLE



schmal
 narrow
 estrecha
 stretta

1x2

cm				
10,5	4 1/4"	11120-10		
11,5	4 1/2"	11120-11		11130-11
12,0	4 3/4"		11122-12	
13,0	5 1/8"	11120-13	11122-13	11130-13
14,5	5 3/4"	11120-14	11122-14	11130-14
15,0	6"			11124-15
15,5	6"		11122-15	
16,0	6 1/4"	11120-16		11130-16
18,0	7"	11120-18	11122-18	11130-18
20,0	8"	11120-20		11130-20
21,0	8 1/4"		11122-21	
25,0	10"	11120-25	11122-25	
30,0	12"	11120-30		



OEHLER



2x3



3x4



4x5

cm				
10,5	4 1/4"			
11,5	4 1/2"		11140-11	
12,0	4 3/4"			
13,0	5 1/8"		11140-13	11150-13
14,5	5 3/4"		11140-14	11150-14
15,0	6"			11160-13
15,5	6"			11160-14
16,0	6 1/4"	11132-16 TC	11140-16	11150-16
18,0	7"	11132-18 TC	11140-18	
20,0	8"	11132-20 TC	11140-20	
21,0	8 1/4"			
25,0	10"	11132-25 TC	11140-25	
30,0	12"	11132-30 TC		

Anatomische und chirurgische Pinzetten
 Dressing and Tissue Forceps
 Pinzas de disección, sin/con dientes
 Pinze per dissezione, chirurgiche/anatomiche



ADSON
 11170-12 12,0 cm, 4 3/4"
 11170-15 15,0 cm, 6"



ADSON
 11174-12 TC 12,0 cm, 4 3/4"
 11174-15 TC 15,0 cm, 6"



ADSON micro
 11176-12 12,0 cm, 4 3/4"
 11176-15 15,0 cm, 6"



Adson-DeBakey atraumatic
 11177-12
 12,0 cm, 4 3/4"



ADSON
 11178-12
 12,0 cm, 4 3/4"



ADSON
 11179-12
 12 cm, 4 3/4"

Anatomische und chirurgische Pinzetten
 Dressing and Tissue Forceps
 Pinzas de disección, sin/con dientes
 Pinze per dissezione, anatomiche/chirurgiche



1x2

ADSON
 11180-12 12,0 cm, 4 3/4"
 11180-15 15,0 cm, 6"



1x2

ADSON
 11181-12 TC 12,0 cm, 4 3/4"
 11181-15 TC 15,0 cm, 6"



1x2

ADSON micro
 11186-12 12,0 cm, 4 3/4"
 11186-15 15,0 cm, 6"



1x2

ADSON
 11187-12
 12 cm, 4 3/4"



7x7

ADSON-BROWN
 11188-12 12,0 cm, 4 3/4"
 11188-15 15,0 cm, 6"
 11189-12 TC 12,0 cm, 4 3/4"

Anatomische und chirurgische Pinzetten
 Dressing and Tissue Forceps
 Pinzas de disección, sin/con dientes
 Pinze per dissezione, chirurgiche/anatomiche



9x9

BROWN

- 11189-15 15,0 cm, 6"
- 11189-20 20,0 cm, 8"
- 11189-25 25,0 cm, 10"



GRAEFE

- 11190-10 10,5 cm, 4.1"



1x2

WAUGH

- 11187-18 18 cm, 7"
- 11187-20 20 cm, 8"
- 11187-25 25 cm, 10"
- 11187-30 30 cm, 11 3/4"



17 cm
6 3/4"

CUSHING

- 11220-17
 - 11224-17 TC**
- 17,0 cm, 6 3/4"



11221-17



1x2

17 cm
6 3/4"

CUSHING

- 11222-17
- 11225-17 TC**



11223-17

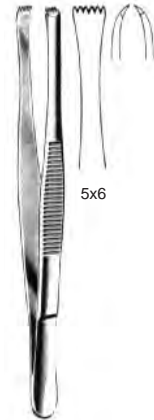

5x6

LERCHE

- 11232-15
- 15,0 cm, 6"

Anatomische und chirurgische Pinzetten, Faßpinzetten
 Dressing and Tissue Forceps
 Pinzas de disección, sin/con dientes
 Pinze per dissezione, chirurgiche/anatomiche



BROPHY
 11231-20
 20,0 cm, 8"



BROPHY
 11233-20
 20,0 cm, 8"



BROPHY



11234-20



11235-20



4x5

ADLERKREUTZ
 11236-15 15,0 cm, 6"
 11236-20 20,0 cm, 8"



DUEHRSEN
 11237-20
 20 cm, 8"



1x2

LANE
 11240-14
 14,5 cm, 5 3/4"



2x3

LANE
 11242-14
 14,5 cm, 5 3/4"

Anatomische und chirurgische Pinzetten, Faßpinzetten
 Dressing and Tissue Forceps
 Pinzas de disección, sin/con dientes
 Pinze per dissezione, chirurgiche/anatomiche



FERRIS-SMITH
 11246-18
 18,0 cm, 7"



FERRIS-SMITH
 11248-18
 18,0 cm, 7"



DUVAL
 11250-14
 14,5 cm, 5 3/4"



COLLIN-DUVAL
 11252-20
 20,0 cm, 8"



Russ. Mod.
 11256-15 15,0 cm, 6"
 11256-20 20,0 cm, 8"
 11256-25 25,0 cm, 10"



McINDOE
 11257-15
 15,0 cm, 6"



McINDOE
 11258-15 15,0 cm, 6"
11259-15 TC 15,0 cm, 6"

Anatomische und chirurgische Pinzetten
 Dressing and Tissue Forceps
 Pinzas de disección, sin/con dientes
 Pinze per dissezione, chirurgiche/anatomiche



SEMKEN

11260-12	12,5 cm, 5"
11260-15	15,5 cm, 6"
11261-15 TC	15,5 cm, 6"



1x2

SEMKEN

11270-12	12,5 cm, 5"
11270-15	15,5 cm, 6"
11271-15 TC	15,5 cm, 6"
11271-18 TC	18 cm, 7"



1x2

GILLIES

11272-15	15,5 cm, 6"
11273-15 TC	15,5 cm, 6"



15,5 cm, 6"



11274-06
0,6 mm

11274-08
0,8 mm

11274-10
1,0 mm



GERALD

11302-17	17,5 cm, 6.9"
11302-23	23,0 cm, 9"
11304-17 TC	17,0 cm, 6 3/4"



GERALD
11303-17
17,5 cm, 6.9"

Anatomische und chirurgische Pinzetten
 Dressing and Tissue Forceps
 Pinzas de disección, sin/con dientes
 Pinze per dissezione, chirurgiche/anatomiche



GERALD
 11305-17
 17,5 cm, 6,9"



GERALD
 11310-17 17,5 cm, 6,9"
 11312-17 TC 17,5 cm, 6,9"



GERALD
 11311-17
 17,5 cm, 6,9"



CUSHING-Taylor
 11312-18 TC
 18,5 cm, 7 1/4"



GERALD
 11313-17
 17,5 cm, 6,9"



11314-01
 17 cm, 6 3/4"



11314-02
 17 cm (6 3/4")
 1x2



11315-01
 17 cm, 6 3/4"



11315-02
 17 cm (6 3/4")
 1x2

TAYLOR

TAYLOR

Anatomische und chirurgische Pinzetten
 Dressing and Tissue Forceps
 Pinzas de disección, sin/con dientes
 Pinze per dissezione, chirurgiche/anatomiche

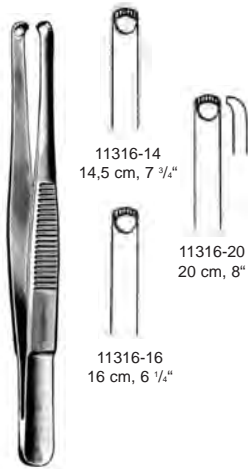

DURANTE

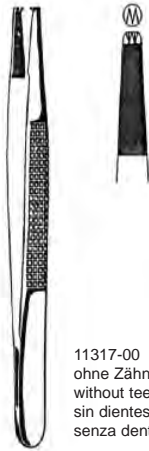

BONNEY
18 cm, 7"

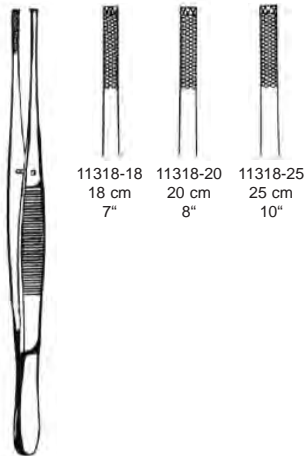

STILLE-BARRAYA
3x4

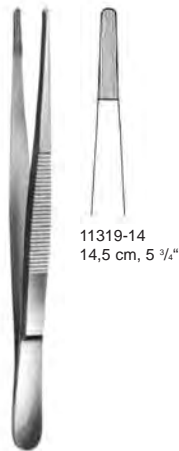

OCHSNER



SINGLEY
11320-18 18 cm 7"
11320-23 23 cm 9"

Anatomische und chirurgische Pinzetten
 Dressing and Tissue Forceps
 Pinzas de disección, sin/con dientes
 Pinze per dissezione, chirurgiche/anatomiche



NELSON
 11322-15 15 cm 6"
 11322-18 18 cm 7"
 11322-23 23 cm 9"



WANGENSTEEN
 11324-23
 23 cm 9"



11325-15 TC
 15 cm, 6"

11325-23 TC
 23 cm, 9"

11325-25 TC
 25 cm, 10"

WANGENSTEEN



MAYO
 23 cm, 9"

11326-23



STRASSBURGER
 MODELL

1x2 Zähne



11328-15
 15 cm, 6"

11328-20
 20 cm, 8"

Splitterpinzetten
 Splinter Forceps
 Pinzas para espinas
 Pinze per schegge

Fig.: 1



11401-01
 12 cm, 4 3/4"

3



11403-03
 12 cm, 4 3/4"

3c



11403-04
 11 cm, 4 3/8"

Fig.: 4



11404-04
 11 cm, 4 3/8"

5



11405-05
 11 cm, 4 3/8"

7



11407-07
 12 cm, 4 3/4"

Splitterpinzetten
Splinter Forceps
Pinzas para espinas
Pinze per schegge



11802-09 9,0 cm, 3 1/2"
11802-10 10,5 cm, 4.1"
11802-11 11,5 cm, 4 1/2"



FEILCHENFELD
11810-07 7,5 cm, 3"
11810-09 9,0 cm, 3 1/2"
11810-11 11,5 cm, 4 1/2"



HUNTER
11812-10 10,5 cm, 4.1"



HUNTER
11813-10
10,5 cm, 4.1"



HUNTER
11815-12
12,5 cm, 5"



CARMALT
11816-10
10,5 cm, 4.1"



CARMALT
11817-10
10,5 cm, 4.1"

Splitterzangen
 Splinter Forceps
 Pinzas para espinas
 Pinze per schegge



PEET
 11821-11
 11,5 cm, 4 1/2"



STIEGLITZ
 11822-13 11823-13
 13,5 cm, 5 1/4"



ARCHER
 11824-14 11825-14
 14 cm, 5 1/2"



VIRTUS (RALK)
 11828-15 11829-15
 15 cm, 6"

Zahnpinzetten
Dental Forceps
Pinzas dentales
Pinze dentali



LONDON-COLLEGE
11900-01
15 cm 6"

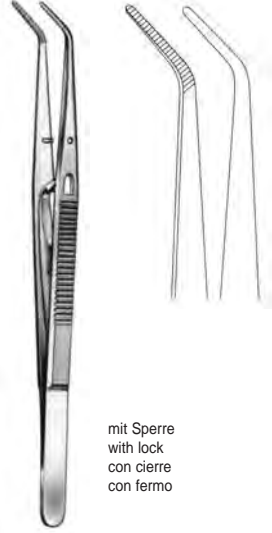

mit Sperre
with lock
con cierre
con fermo

LONDON-COLLEGE
11901-05
15 cm 6"



MERIAM
11910-01
15 cm 6"

Mikrochirurgie-Pinzetten
Microsurgery Forceps
Pinzas para microcirugía
Pinze per microchirurgia



12102-12
12 cm, 4 3/4"



12103-12
12 cm, 4 3/4"



12104-15
15 cm, 6"



12105-15
15 cm, 6"



12108-18
18 cm, 7"



12109-18
18 cm, 7"

Ultra-Light-Pinzetten
 Ultra-Light-Forceps
 Pinzas-Ultra-Ligera
 Pinza-ultra-leggera

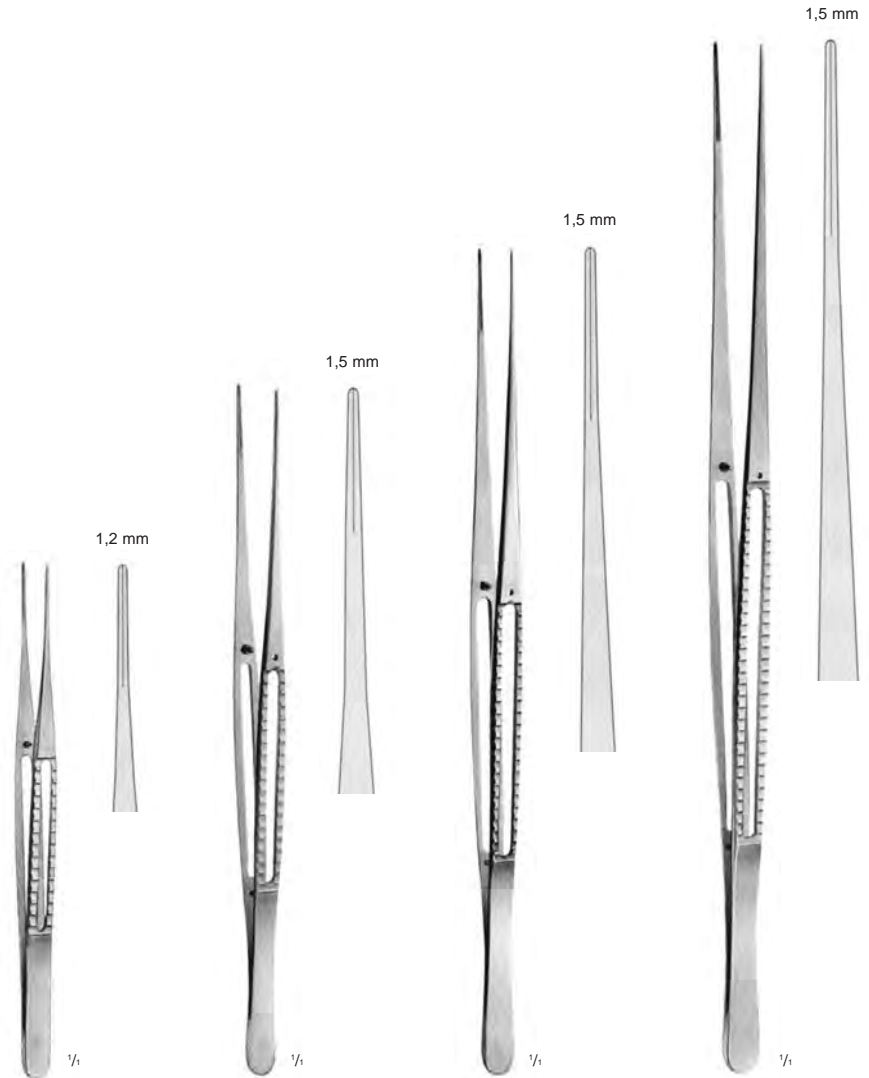

12110-15
 15 cm, 6"

12110-20
 20 cm, 8"

12110-24
 24 cm, 9 1/2"

12110-30
 30 cm, 11 3/4"

Mikrochirurgie-Pinzetten
Microsurgery Forceps
Pinzas para microcirugía
Pinze per microchirurgia

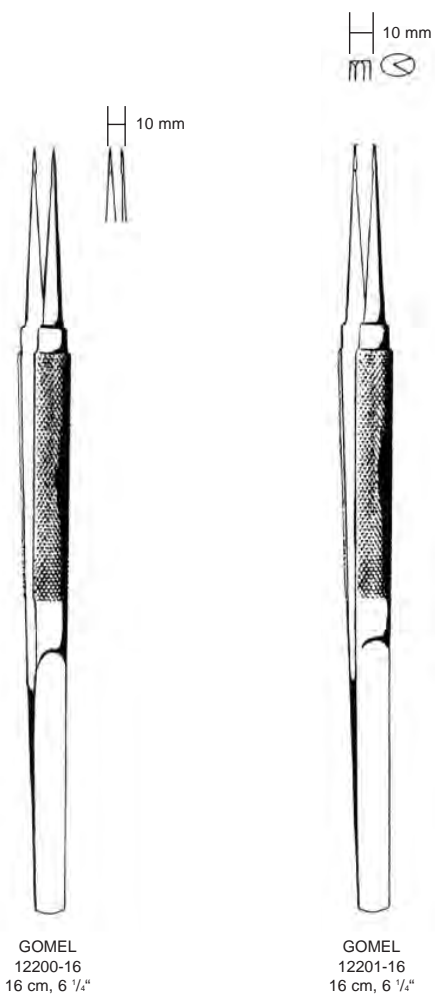

Tumorpinzetten
Tumor forceps
Pinzas para tumores
Pinze per tumori

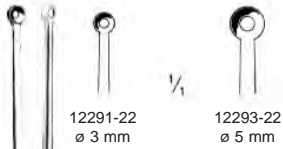

$\frac{1}{2}$

YASARGIL
12291-22 – 12293-22
22 cm, 8 $\frac{3}{4}$ "



$\frac{1}{2}$

YASARGIL
12295-22 – 12297-22
22 cm, 8 $\frac{3}{4}$ "

Atraumatische Pinzetten
 Atraumatic Tissue Forceps
 Pinzas atraumáticas
 Pinze atraumatiche

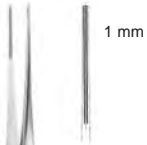

DE BAKEY
 12302-16 16 cm, 6 1/4"
 12302-20 20 cm, 8"
 12302-24 24 cm, 9 1/2"

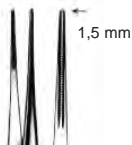

DE BAKEY
 12306-16 16 cm, 6 1/4"
 12306-20 20 cm, 8"
 12306-24 24 cm, 9 1/2"
 12306-30 30 cm, 11 3/4"

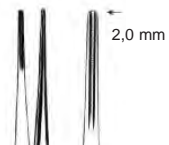

DE BAKEY
 12308-16 16 cm, 6 1/4"
 12308-20 20 cm, 8"
 12308-24 24 cm, 9 1/2"
 12308-30 30 cm, 11 3/4"



DE BAKEY
 12309-16 16 cm, 6 1/4"
 12309-20 20 cm, 8"
 12309-24 24 cm, 9 1/2"
 12309-30 30 cm, 11 3/4"

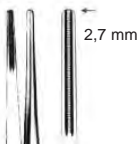

DE BAKEY
 12304-16 16 cm, 6 1/4"
 12304-20 20 cm, 8"
 12304-24 24 cm, 9 1/2"
 12304-30 30 cm, 11 3/4"

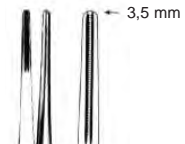

DE BAKEY
 12310-16 16 cm, 6 1/4"
 12310-20 20 cm, 8"
 12310-24 24 cm, 9 1/2"
 12310-30 30 cm, 11 3/4"

Atraumatische Pinzetten
 Atraumatic Tissue Forceps
 Pinzas atraumáticas
 Pinze atraumatiche

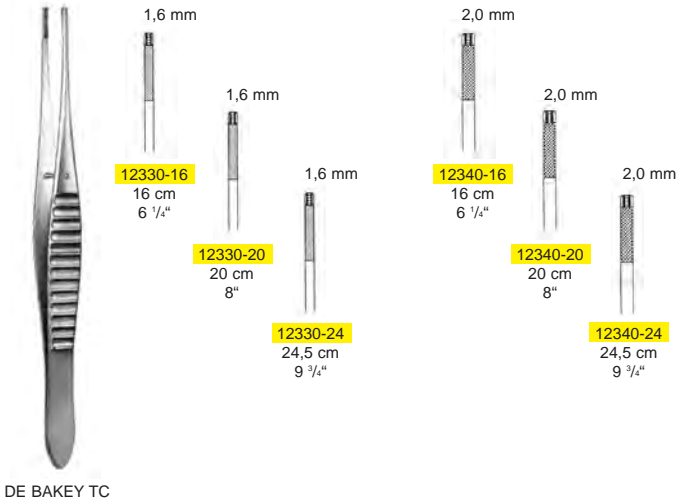
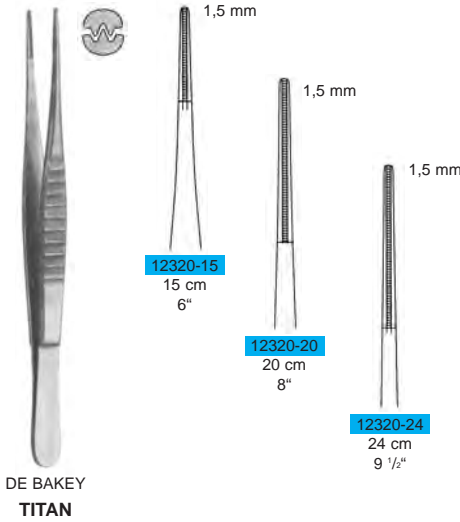

Atrauma-Bulldogklemmen
 Atrauma-Bulldog Clamps
 Clamps Atrauma Bulldog
 Pinze Atrauma Bulldog

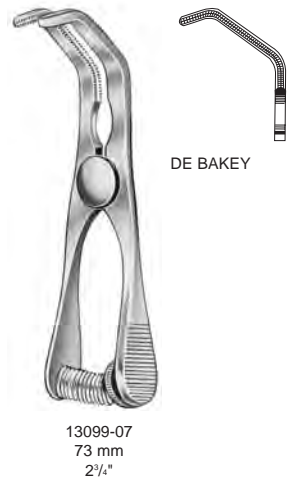
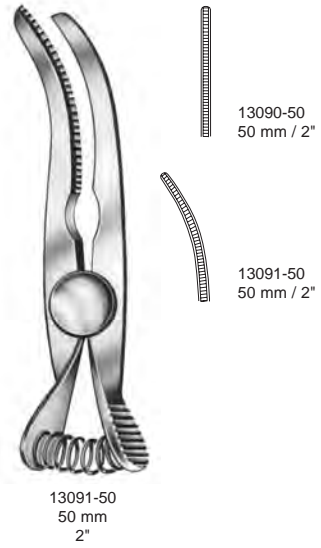
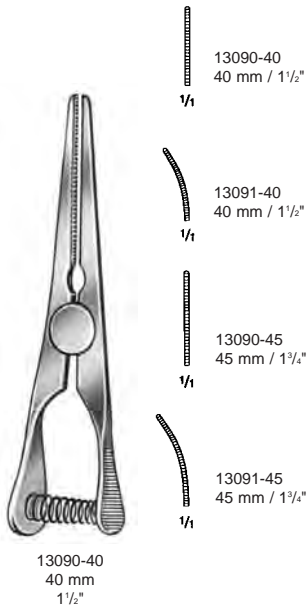

Mini-Bulldogklemmen
 Mini Bulldog Clamps
 Clamps Bulldog Mini
 Pinze Bulldog Mini

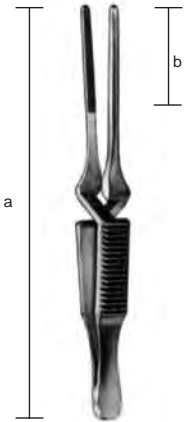

Diethrich

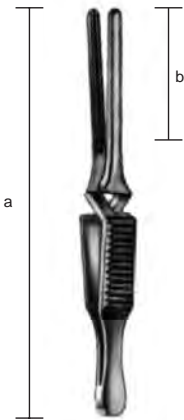
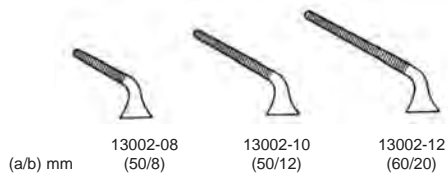
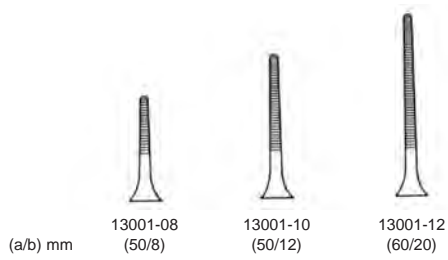

DeBakey-Diethrich

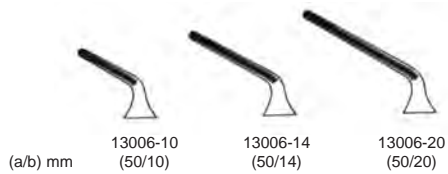
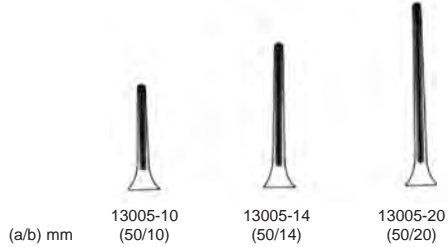

Titan-Atrauma-Bulldogklemmen
 Titanium Atrauma Bulldog Clamps
 Titan Clamp Bulldog
 Titan Pinze Bulldog



3 cm, 1.2"

Vene [13010-30](#)
 Arterie [13011-30](#)



3,5 cm, 1.4"

[13010-35](#)
[13011-35](#)



4 cm, 1 1/2"

[13010-40](#)
[13011-40](#)



5 cm, 2"

[13010-50](#)
[13011-50](#)



3 cm, 1.2"

Vena [13012-30](#)
 Arteria [13013-30](#)



3,5 cm, 1.4"

[13012-35](#)
[13013-35](#)



4 cm, 1 1/2"

[13012-40](#)
[13013-40](#)



5 cm, 2"

[13012-50](#)
[13013-50](#)



3 cm, 1.2"

Vene [13014-30](#)
 Arterie [13015-30](#)



3,5 cm, 1.4"

[13014-35](#)
[13015-35](#)



4 cm, 1 1/2"

[13014-40](#)
[13015-40](#)



5 cm, 2"

[13014-50](#)
[13015-50](#)

Atrauma-Bulldogklemmen
 Atrauma Bulldog Clamps
 Clamps Atrauma Bulldog
 Pinze Atrauma Bulldog



DE BAKEY

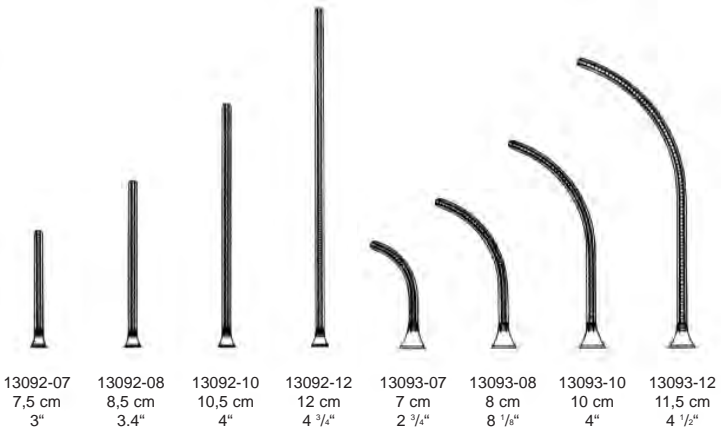

13092-07
7,5 cm
3"

13092-08
8,5 cm
3.4"

13092-10
10,5 cm
4"

13092-12
12 cm
4 3/4"

13093-07
7 cm
2 3/4"

13093-08
8 cm
8 1/8"

13093-10
10 cm
4"

13093-12
11,5 cm
4 1/2"



GLOVER

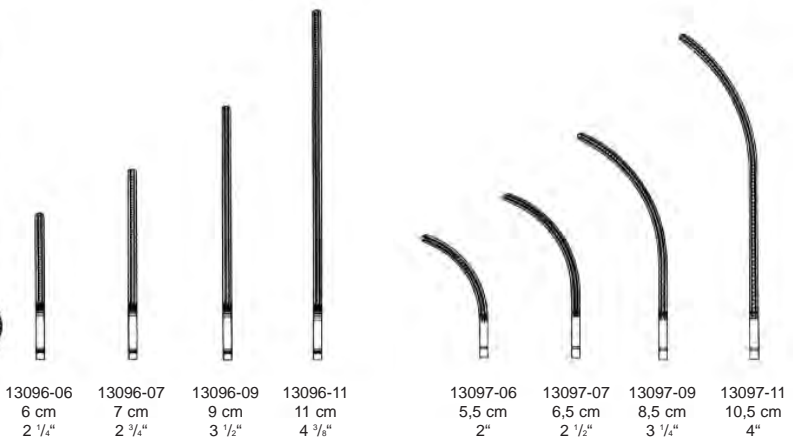

13096-06
6 cm
2 1/4"

13096-07
7 cm
2 3/4"

13096-09
9 cm
3 1/2"

13096-11
11 cm
4 3/8"

13097-06
5,5 cm
2"

13097-07
6,5 cm
2 1/2"

13097-09
8,5 cm
3 1/4"

13097-11
10,5 cm
4"

Gefäßklemmen, Bulldogklemmen, Arterienklemmen
 Hemostatic Forceps
 Pinzas hemostáticas
 Pinze serrafina, Pinze emostatiche



DIEFFENBACH
 13102-04 3,5 cm, 1,4"
 13102-05 5,5 cm, 2,2"



gerade
 straight
 recta
 rette

gebogen
 curved
 curva
 curve

JOHNS-HOPKINS

13110-50	5,0 cm, 2"	13111-50
13110-55	5,5 cm, 2,2"	13111-55
13110-65	6,5 cm, 2,6"	13111-65
13110-70	7,0 cm, 2 3/4"	13111-70
13110-75	7,5 cm, 3"	13111-75
13110-90	9,0 cm, 3 1/2"	13111-90



DIEFFENBACH
 13103-04 3,5 cm, 1,4"
 13103-05 5,5 cm, 2,2"

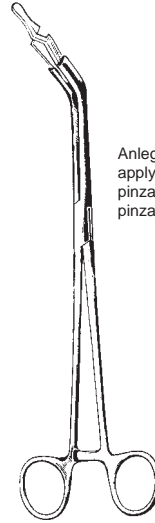

Anlegezange
 applying forceps
 pinza para poner
 pinza applicatrice

13115-00
 23 cm, 9"

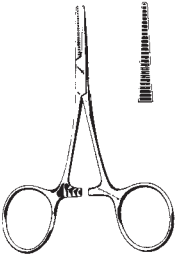

HARTMANN
 13210-10
 10 cm, 4"

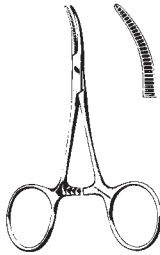

HARTMANN
 13211-10
 10 cm, 4"

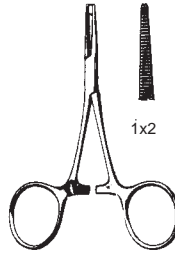

HARTMANN
 13212-10
 10 cm, 4"

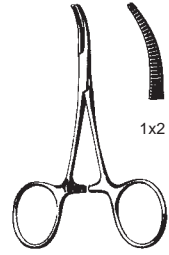

HARTMANN
 13213-10
 10 cm, 4"

Micro-HARTMANN
 13214-10
 10 cm, 4"

Micro-HARTMANN
 13215-10
 10 cm, 4"

Arterienklemmen
 Hemostatic Forceps
 Pinzas hemostáticas
 Pinze emostatiche

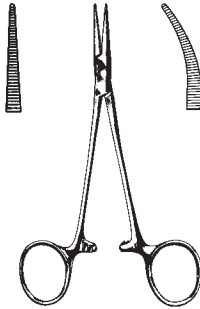

cm TITAN
 12,5 5" 13224-12
 14,0 5 1/2"
 18,0 7"
 21,0 8 1/4"

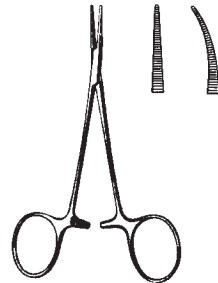

TITAN HALSTED-MOSQUITO TITAN
 13224-12 13220-12 12,5 cm, 5" 13221-12
 13220-14 14,0 cm, 5 1/2" 13221-14
 13220-18 18,0 cm, 7" 13221-18
 13220-21 21,0 cm, 8 1/4" 13221-21

HALSTED-MOSQUITO micro
 13222-12 12,5 cm, 5" 13223-12
 JACOBSON micro
 13226-12 12,0 cm, 4 3/4" 13227-12

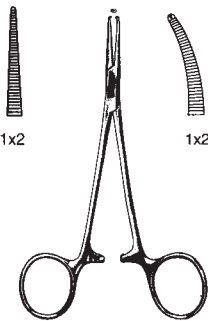

HALSTED-MOSQUITO
 13230-12 12,5 cm, 5" 13231-12
 13230-14 14,0 cm, 5 1/2" 13231-14
 13230-18 18,0 cm, 7" 13231-18
 13230-21 21,0 cm, 8 1/4" 13231-21

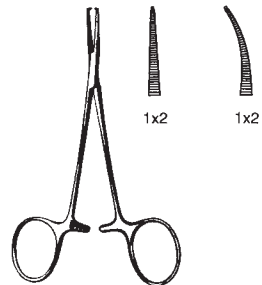

HALSTED-MOSQUITO micro
 13232-12 13233-12

Arterienklemmen
 Hemostatic Forceps
 Pinzas hemostáticas
 Pinze emostatiche

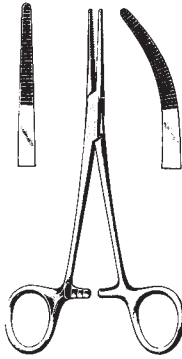

KELLY
 13240-14 14 cm, 5 1/2" 13241-14
 13240-18 18 cm, 7" 13241-18
 13244-14 14 cm, 5 1/2" 13245-14
 TITAN TITAN

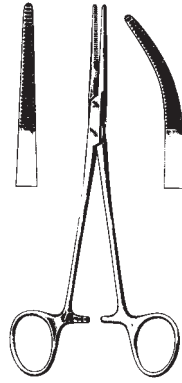

KELLY-RANKIN
 13242-16 16 cm, 6 1/4" 13243-16

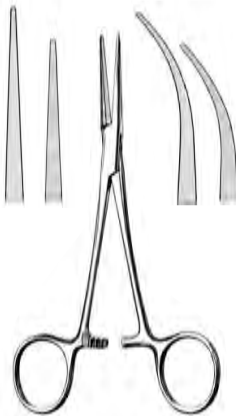

COLLER-CRILE
 13256-14 14 cm, 5 1/2" 13257-14
 13258-16 16 cm, 6 1/4" 13259-16

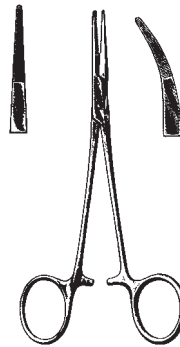

PROVIDENCE-HOSPITAL
 13270-14 14 cm, 5 1/2" 13271-14

Arterienklemmen
 Hemostatic Forceps
 Pinzas hemostáticas
 Pinze emostatiche

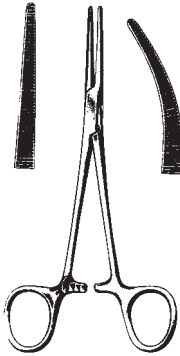

CRILE
 13250-14 14 cm, 5 1/2" 13251-14
 13250-18 18 cm, 7" 13251-18
 13254-14 14 cm, 5 1/2" 13255-14
 TITAN TITAN

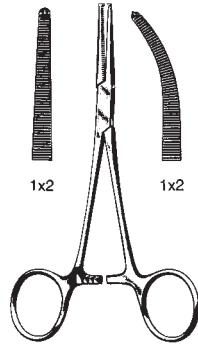

CRILE
 13260-14 14 cm, 5 1/2" 13261-14

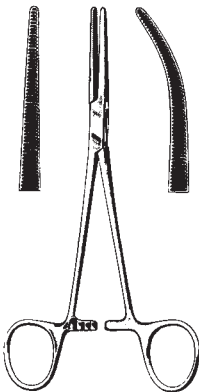

CRILE-RANKIN
 13262-16 16 cm, 6 1/4" 13263-16

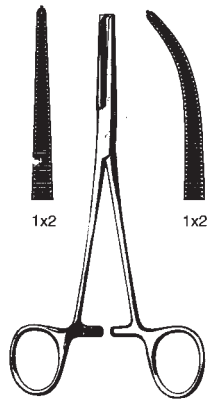

CRILE-RANKIN
 13264-16 16 cm, 6 1/4" 13265-16

Arterienklemmen
 Hemostatic Forceps
 Pinzas hemostáticas
 Pinze emostatiche

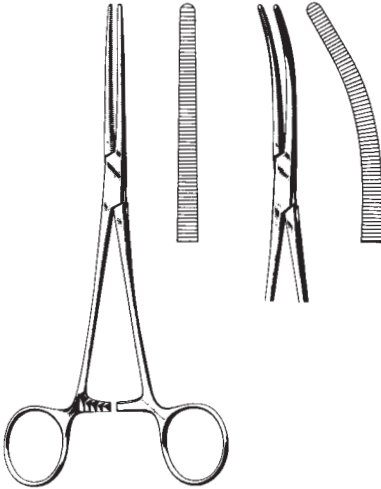

ROCHESTER-PEAN

13310-13	13 cm, 5 1/8"	13311-13
13310-14	14 cm, 5 1/2"	13311-14
13310-16	16 cm, 6 1/4"	13311-16
13310-18	18 cm, 7"	13311-18
13310-20	20 cm, 8"	13311-20
13310-22	22 cm, 8 3/4"	13311-22
13310-24	24 cm, 9 1/2"	13311-24
13310-26	26 cm, 10 1/4"	13311-26
13310-30	30 cm, 11 3/4"	13311-30

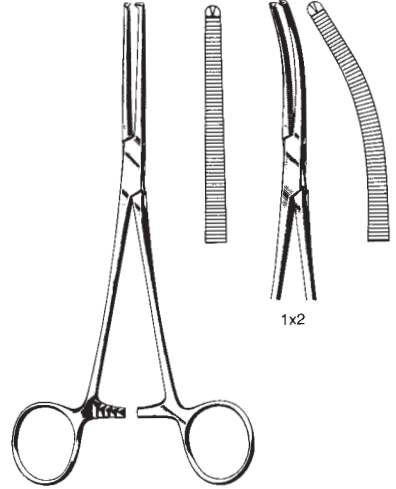

ROCHESTER-OGHSNER

13320-13	13 cm, 5 1/8"	13321-13
13320-14	14 cm, 5 1/2"	13321-14
13320-16	16 cm, 6 1/4"	13321-16
13320-18	18 cm, 7"	13321-18
13320-20	20 cm, 8"	13321-20
13320-22	22 cm, 8 3/4"	13321-22
13320-24	24 cm, 9 1/2"	13321-24
13320-26	26 cm, 10 1/4"	13321-26
13320-30	30 cm, 11 3/4"	13321-30

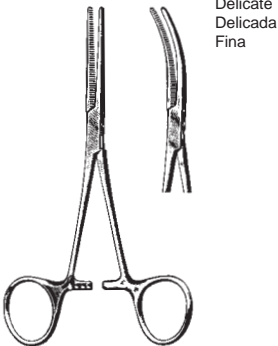

PEAN

13312-14	14 cm, 5 1/2"	13313-14
13312-16	16 cm, 6 1/4"	13313-16

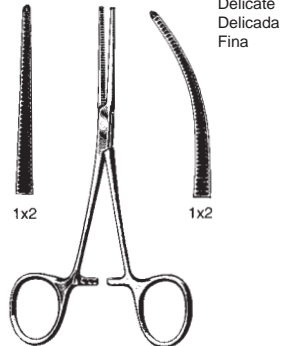

KOCHER

13322-14	14 cm, 5 1/2"	13323-14
13322-16	16 cm, 6 1/4"	13323-16

Arterienklemmen
 Hemostatic Forceps
 Pinzas hemostáticas
 Pinze emostatiche

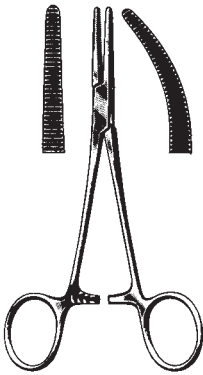

SPENCER-WELLS

- | | | |
|----------|-----------|----------|
| 13330-13 | 13 cm, 5" | 13331-13 |
| 13330-15 | 15 cm, 6" | 13331-15 |
| 13330-18 | 18 cm, 7" | 13331-18 |
| 13330-20 | 20 cm, 8" | 13331-20 |

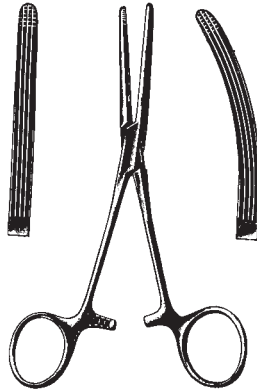

ROCHESTER-CARMALT

- | | | |
|----------|---------------|----------|
| 13340-16 | 16 cm, 6 1/4" | 13341-16 |
| 13340-20 | 20 cm, 8" | 13341-20 |

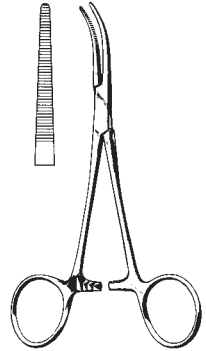

DANDY

- | | |
|----------|---------------|
| 13345-12 | 12 cm, 4 3/4" |
| 13345-14 | 14 cm, 5 1/2" |

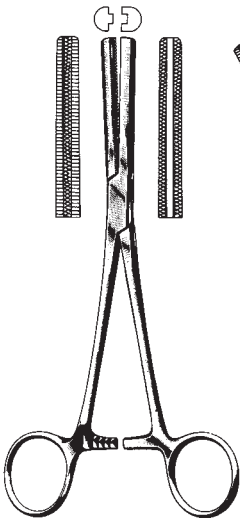

FERGUSSON

- | | | |
|----------|---------------|----------|
| 13350-16 | 16 cm, 6 1/4" | 13351-16 |
| 13350-20 | 20 cm, 8" | 13351-20 |

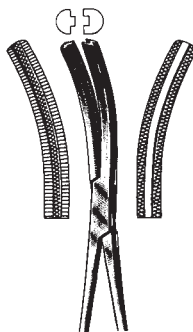

LOVELACE

- | | |
|----------|-------------|
| 13356-15 | 15,5 cm, 6" |
|----------|-------------|

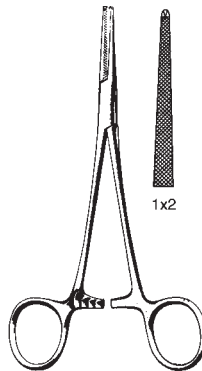

PENNINGTON

- | | |
|----------|-------------|
| 13358-15 | 15,5 cm, 6" |
| 13358-20 | 20,0 cm, 8" |

Fasszangen
 Grasping Forceps
 Pinza para agarrar órganos y tejidos
 Pinze da presa

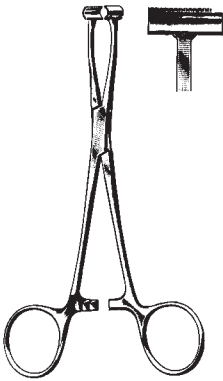

PRATT
 13360-15 15 cm, 6"

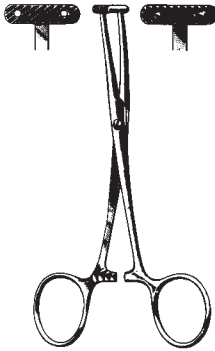

MARTEL
 13364-14 14 cm, 5 1/2"

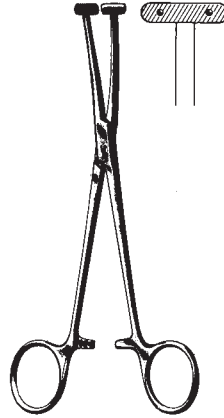

WILLET MARTEL
 13366-19 19 cm, 7 1/2"

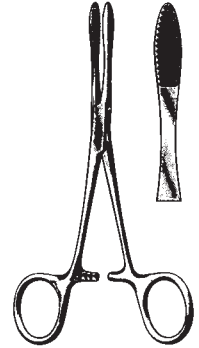

PEAN
 13368-14 14 cm, 5 1/2"
 13368-16 16 cm, 6 1/4"

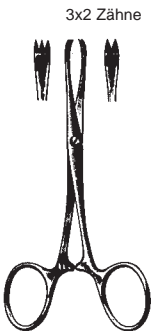

CHAPUT
 13370-13
 13 cm, 5 1/4"

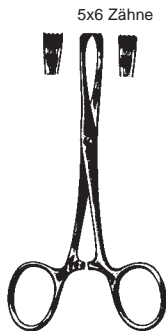

TUFFIER
 13372-13
 13 cm, 5 1/4"

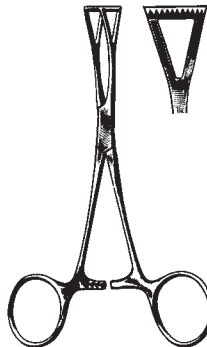

COLLIN
 13374-14
 14 cm, 5 1/2"

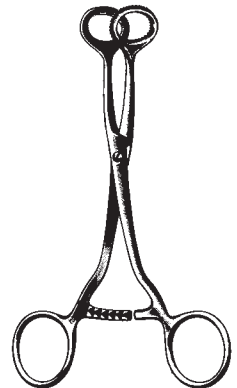

COLLIN
 13376-16
 16 cm, 6 1/4"

Organ- und Gewebefasszange, Arterienklemmen
 Organ- and Tissue Grasping Forceps, Hemostatic Forceps
 Pinza para agarrar órganos y tejidos, Pinzas hemostáticas
 Pinza per tessuti e organi, Pinze emostatiche



REDA
 ATRAUMA
 13377-25 - 13377-26



13377-25
 25 cm, 10"



13377-26
 26 cm, 10 1/4"



LERICHE
 13380-15 15 cm, 6" 13381-15

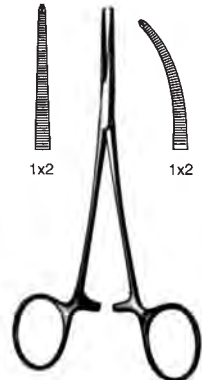

LERICHE
 13382-15 15 cm, 6" 13383-15

Arterienklemmen
 Hemostatic Forceps
 Pinzas hemostáticas
 Pinze emostatiche

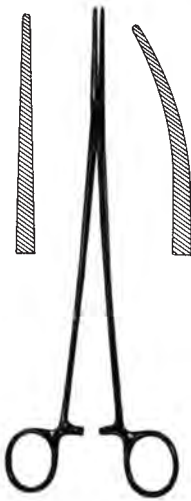

BENGOLEA

13384-20 20 cm, 8" 13385-20
 13384-26 26 cm, 10 1/4" 13385-26

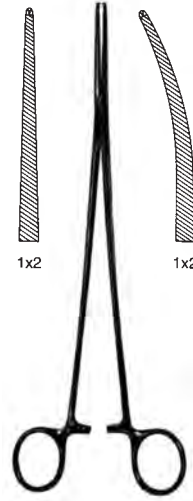

BENGOLEA

13386-20 20 cm, 8" 13387-20
 13386-26 26 cm, 10 1/4" 13387-26

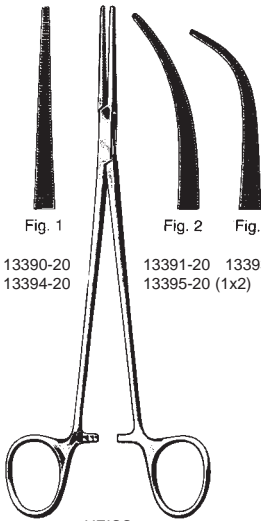

Fig. 1

Fig. 2

Fig. 3

13390-20
 (1x2) 13394-20

13391-20 13393-20
 13395-20 (1x2)

HEISS
 20 cm, 8"

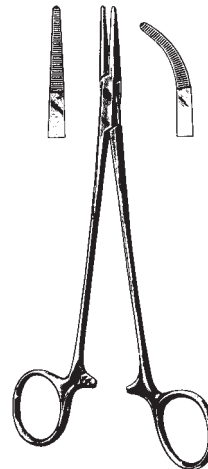

ADSON

13410-18 18,5 cm, 7 1/4" 13411-18

Arterienklemmen
 Hemostatic Forceps
 Pinzas hemostáticas
 Pinze emostatiche

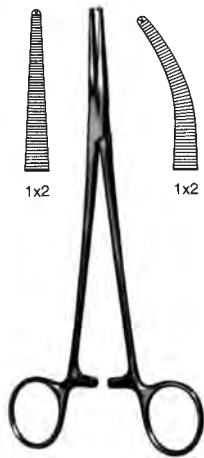

ADSON
 13412-18 18,5 cm, 7 1/4" 13413-18



Fuchsig
 13414-20 19 cm, 7 1/2"



ADSON BABY
 13415-14 14,0 cm, 5 1/2"
 13415-18 18,5 cm, 7 1/4"



NISSEN
 13416-18 18,5 cm, 7 1/4"

Arterienklemmen
 Hemostatic Forceps
 Pinzas hemostáticas
 Pinze emostatiche



OVERHOLT-BABY
 13420-14
 14 cm, 5 1/2"



OVERHOLT-GEISSENDOERFER
 21 cm, 8 1/4"

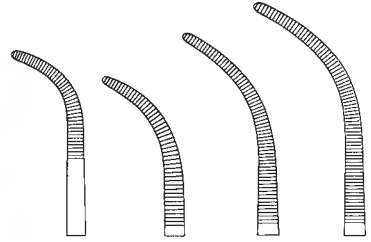

Fig. 1 13421-01
 Fig. 2 13421-02 13425-02 26 cm 10 1/4"
 Fig. 3 13421-03 13425-03 27 cm 10 1/2"
 Fig. 4 13421-04 13425-04 27.5 cm 10.8"

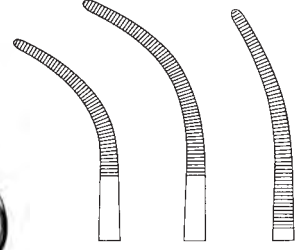
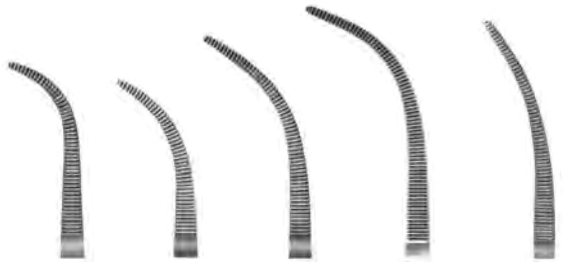

Fig. 5 13421-05 13425-05 27 cm 10 1/2"
 Fig. 6 13421-06 13425-06 28 cm 11"
 Fig. 7 13421-07



OVERHOLT



13422-00 21,5 cm 8 1/2" Fig. ①
 13422-01 21 cm 8 1/4" ①
 13422-02 22 cm 8 3/4" ②
 13422-03 23 cm 9" ③
 13422-06 22,5 cm 8.9" ⑥

Arterienklemmen
 Hemostatic Forceps
 Pinzas hemostáticas
 Pinze emostatiche

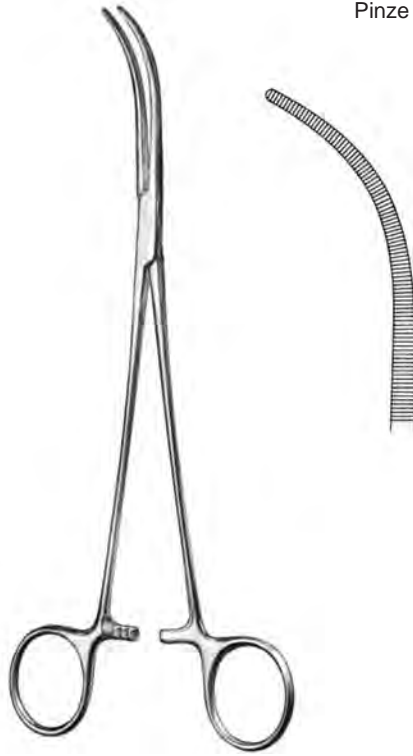

OVERHOLT-MIXTER
 13428-21
 21,5 cm, 8 1/2"



GEMINI



13431-13
 13 cm
 5 1/8"

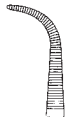

13431-16
 16 cm
 6 1/4"



13431-18
 18 cm
 7"



13431-20
 20 cm
 8"



13431-23
 23 cm
 9"



13431-25
 25 cm
 10"

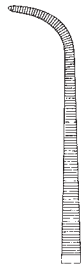

13431-28
 28 cm
 11"

Arterienklemmen
 Hemostatic Forceps
 Pinzas hemostáticas
 Pinze emostatiche



BIRKETT

13432-19
 18,5 cm
 7 1/4"

13433-19
 18,5 cm
 7 1/4"

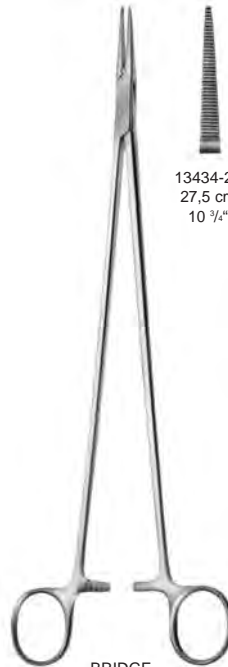

BRIDGE

13434-28
 27,5 cm
 10 3/4"

13435-28
 27,5 cm
 10 3/4"



MIXTER



13438-01
 18,5 cm
 7 1/4"



13438-02
 21 cm
 8 1/2"



13438-03
 21,5 cm
 8 1/2"



13438-04
 22 cm
 8 1/4"

Arterienklemmen
 Hemostatic Forceps
 Pinzas hemostáticas
 Pinze emostatiche



RUMEL
 23 cm, 9"



13441-01



13441-02



13441-03

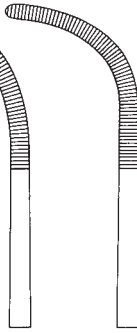

13441-04



WIKSTROEM
 13447-20
 20,5 cm, 8"



13442-21 21 cm, 8 1/4"
 13442-26 26 cm, 10 1/4"



21 cm, 8 1/4" 13443-21
 26 cm, 10 1/4" 13443-26



13448-22 22 cm, 8 3/4" 13449-22



1x2

13444-21 21 cm, 8 1/4"
 13444-26 26 cm, 10 1/4"

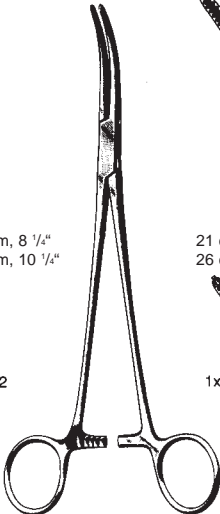

TOENNIS

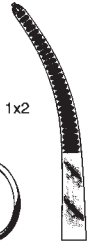

1x2

21 cm, 8 1/4" 13445-21
 26 cm, 10 1/4" 13445-26

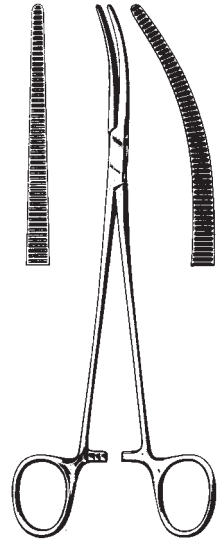

ROBERTS

Arterienklemmen
 Hemostatic Forceps
 Pinzas hemostáticas
 Pinze emostatiche



CRAFOORD
 13453-18 18 cm, 7"
 13453-24 24 cm, 9 1/2"

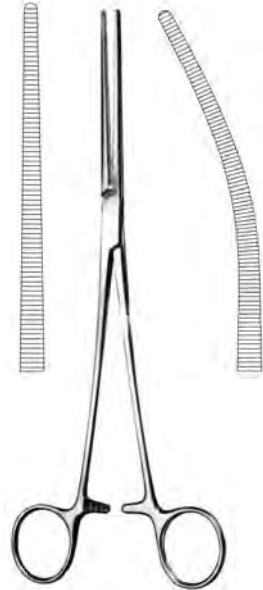

SAROT
 13450-24 24 cm, 9 1/2" 13451-24



ZENKER
 29,5 cm, 11 1/2"

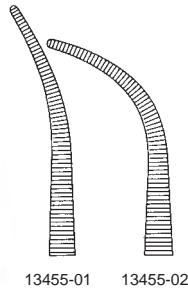

13455-01 13455-02

Arterienklemmen
 Hemostatic Forceps
 Pinzas hemostáticas
 Pinze emostatiche

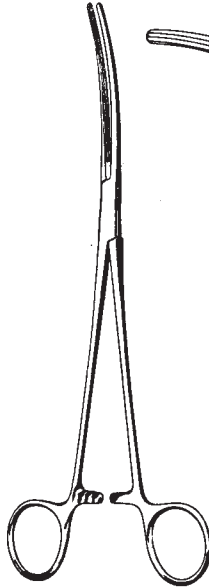

CRAFOORD-SELLORS
 24 cm, 9 1/2"

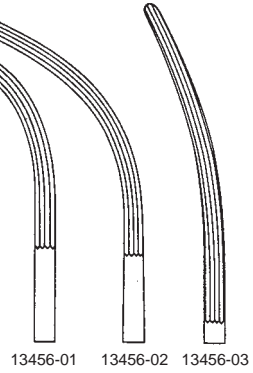

LAWRENCE
 13457-28 28 cm, 11"



MEEKER
 13459-18 18 cm, 7"
 13459-28 28 cm, 11"

Arterienklemmen
 Hemostatic Forceps
 Pinzas hemostáticas
 Pinze emostatiche

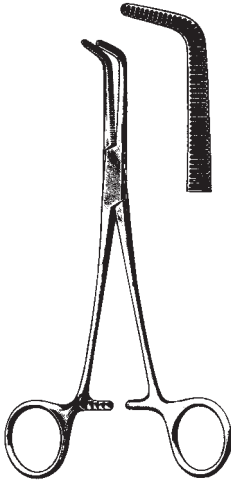

MIXTER
 13471-14 14 cm, 5 1/2"
 13471-16 16 cm, 6 1/4"
 13471-18 18 cm, 7"
 13471-23 23 cm, 9"

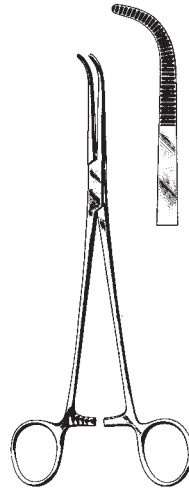

MIXTER
 13473-22
 22 cm, 8 3/4"



KANTROWITZ
 13474-19 19 cm, 7 1/2"
 13474-24 24 cm, 9 1/2"
 13474-26 26 cm, 10 1/4"

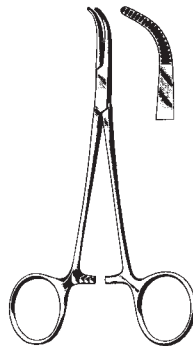

MIXTER BABY
 13475-14
 14 cm, 5 1/2"



MIXTER BABY
 13475-18
 18 cm, 7"

Arterienklemmen
 Hemostatic Forceps
 Pinzas hemostáticas
 Pinze emostatiche



MIXTER-O'SHAUGHNESSY
 13477-15 15,5 cm, 6"
 13477-19 19,0 cm, 7 1/2"

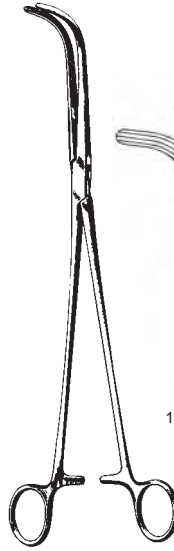

MIXTER



13479-22 22 cm 8 3/4"
 13479-25 25 cm 10"
 13479-28 28 cm 11"

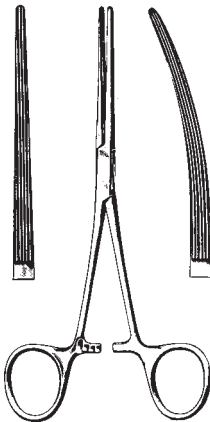

BAINBRIDGE
 13480-15 15,0 cm, 6" 13481-15
 13480-18 18,5 cm, 7 1/4" 13481-18

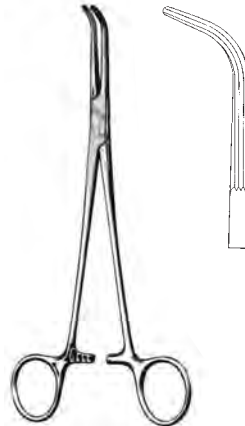

LAHEY
 13491-19 19 cm, 7 1/2"

Arterienklemmen
 Hemostatic Forceps
 Pinzas hemostáticas
 Pinze emostatiche

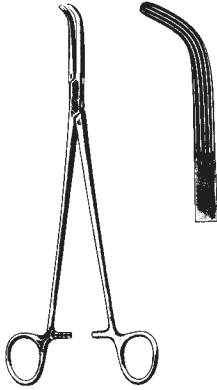

LAHEY
 13493-23 23 cm, 9"

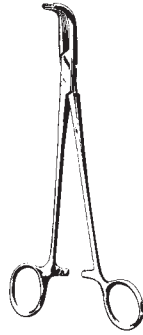

LOWER
 13495-18 18 cm, 7"

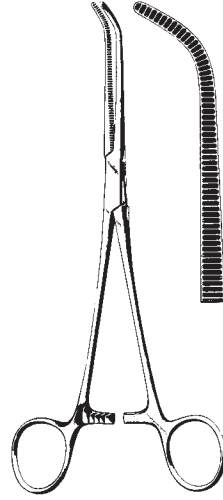

JOHNS-HOPKINS
 13497-20 20 cm, 8"

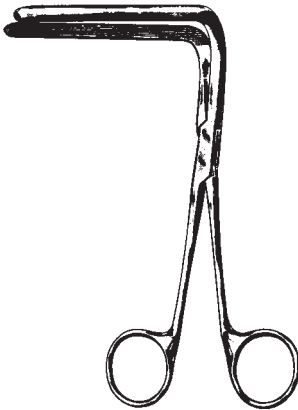

MIXTER
 13499-16
 16,5 cm, 6 1/2"

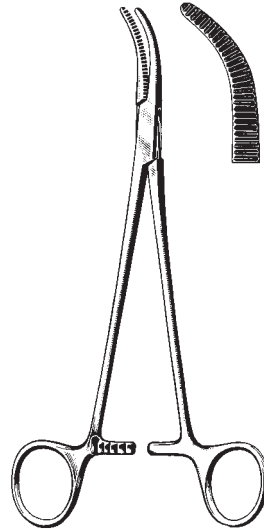

MOYNIHAN
 13501-23
 23 cm, 9"

Arterienklemmen
Hemostatic Forceps
Pinzas hemostáticas
Pinze emostatiche



DESJARDINS
13503-21 21 cm, 8 1/4"

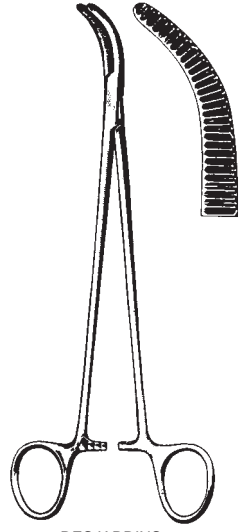

DESJARDINS
13505-21 21 cm, 8 1/4"

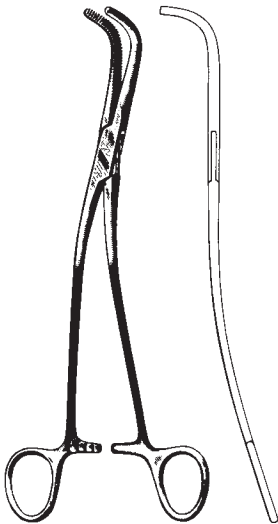

GRAY

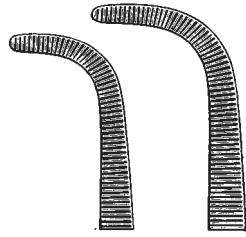

13507-22
22 cm
8 3/4"

13507-23
23 cm
9"

Arterienklemmen
 Hemostatic Forceps
 Pinzas hemostáticas
 Pinze emostatiche

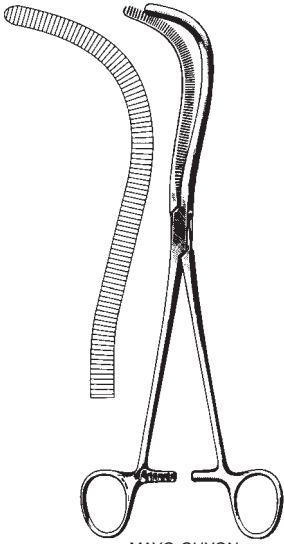

MAYO-GUYON
 13513-23
 23 cm, 9"

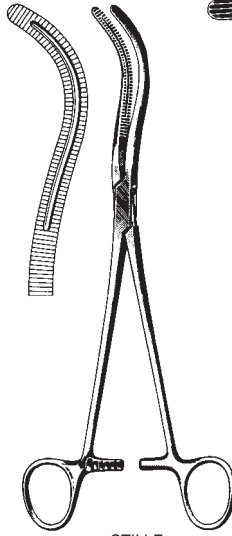

STILLE
 13515-23
 23 cm, 9"

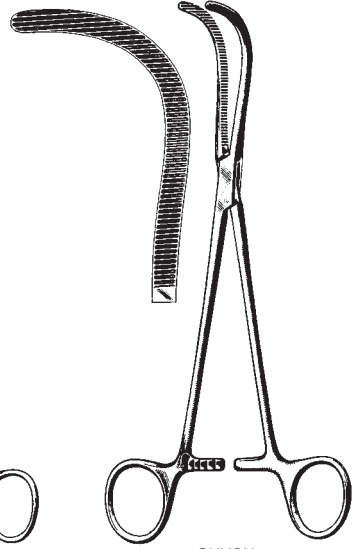

GUYON
 13517-23
 23 cm, 9"



GUYON

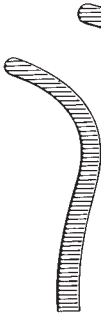

13519-20
 20 cm
 8"



13519-22
 22 cm
 8 3/4"



13519-24
 24 cm
 9 1/2"



GUYON



13520-24
 24 cm
 9 1/2"

13520-23
 23 cm
 9"

ATRAUMA

Hysterektomieklemmen
 Hysterectomy Forceps
 Pinzas para hysterectomia
 Pinze per isterectomia

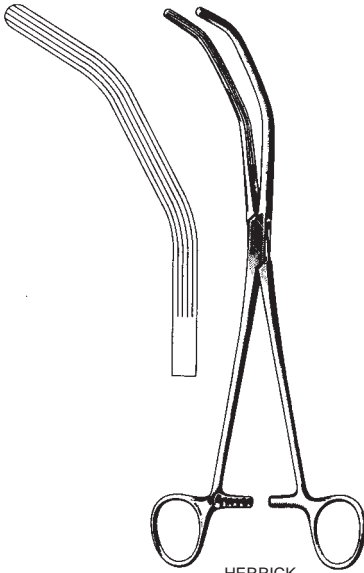

HERRICK
 13523-23
 23 cm, 9"

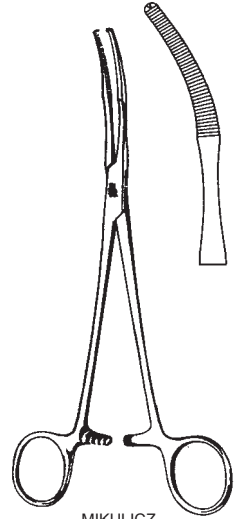

MIKULICZ
 13551-14 14 cm, 5 1/2" BABY
 13551-18 18 cm, 7"
 13551-20 20 cm, 8"

Peritoneum-Klemme
 Peritoneum Forceps
 Pinzas para peritoneo
 Pinze peritoneali

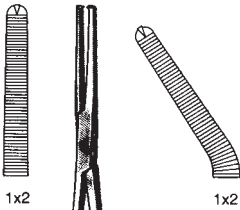

1x2

1x2

PHANEUF
 13554-21 21 cm, 8 1/4" 13555-21



MIKULICZ
 13556-24 24 cm, 9 1/2"

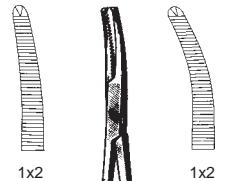

1x2

1x2

FAURE
 13561-20 20 cm, 8" 13563-20

Hysterektomieklemmen
Hysterectomy Forceps
Pinzas para histerectomía
Pinze per isterectomia



WERTHEIM
13570-23
23,5 cm, 9 1/4"

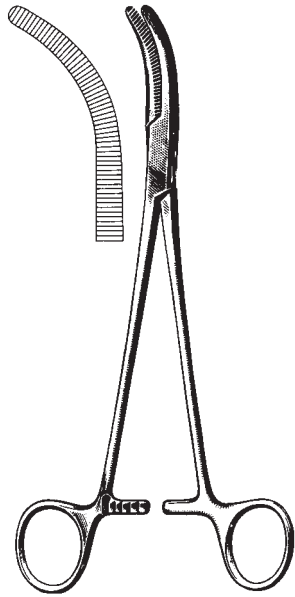

WERTHEIM
13571-25
25 cm, 10"

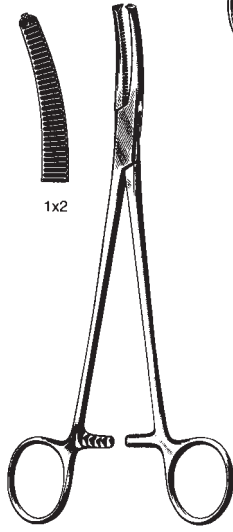

WERTHEIM
13573-22 22 cm, 8 3/4"

Hysterektomieklemmen
 Hysterectomy Forceps
 Pinzas para histerectomía
 Pinze per isterectomia



SEGOND-LANDAU
 13574-24
 24 cm, 9 1/2"



SEGOND
 13575-24
 24 cm, 9 1/2"

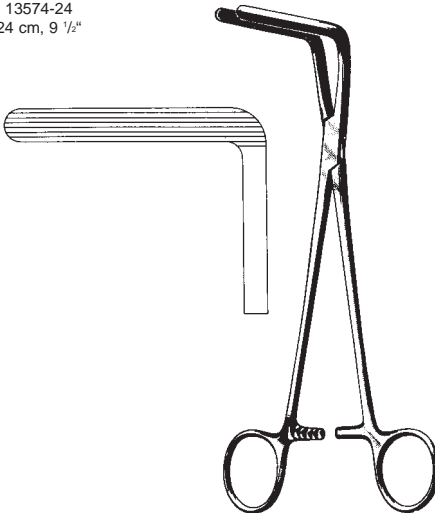

WERTHEIM-CULLEN
 13579-21 21,5 cm, 8 1/2"

Hysterektomieklemmen
Hysterectomy Forceps
Pinzas para histerectomía
Pinze per isterectomia



Hysterektomieklemmen
 Hysterectomy Forceps
 Pinzas para histerectomia
 Pinze per isterectomia

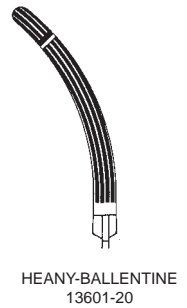
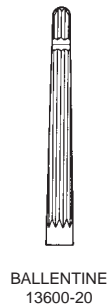
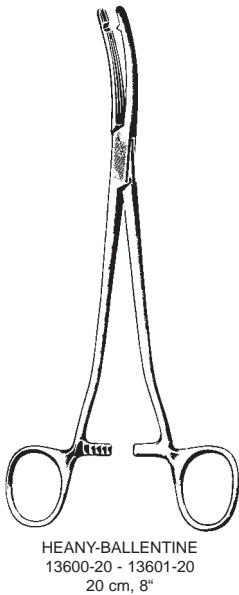
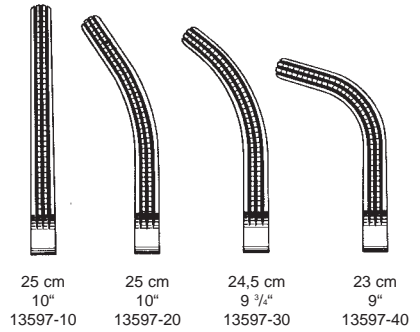
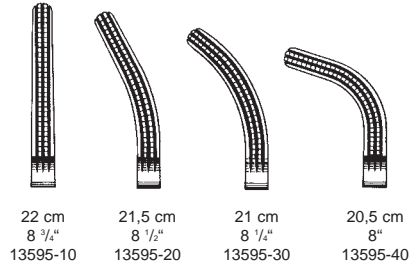

Hysterektomieklemmen
Hysterectomy Forceps
Pinzas para histerectomía
Pinze per isterectomia



WERTHEIM
13605-26
25,5 cm, 10"

Schlauchklemmen
 Tubing Clamps
 Pinzas cierra-tubos
 Pinze serratubi



KLINIKUM BERLIN
 13702-14
 14,5 cm, 5 3/4"



13710-15
 15 cm, 6"



13710-18
 18 cm, 7"



13710-20
 20 cm, 8"



PRESBYTERIAN
 13704-16 16 cm, 6 1/4"
 13704-18 18 cm, 7"

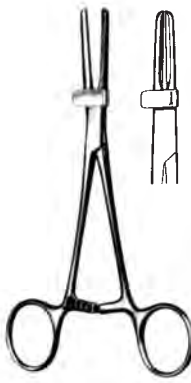

13712-15
 15 cm, 6"



13712-18
 18 cm, 7"



13712-20
 20 cm, 8"



Schlauchklemme
Tubing clamps
Pinzas cierra-tubos
Pinze serratubi a rulli

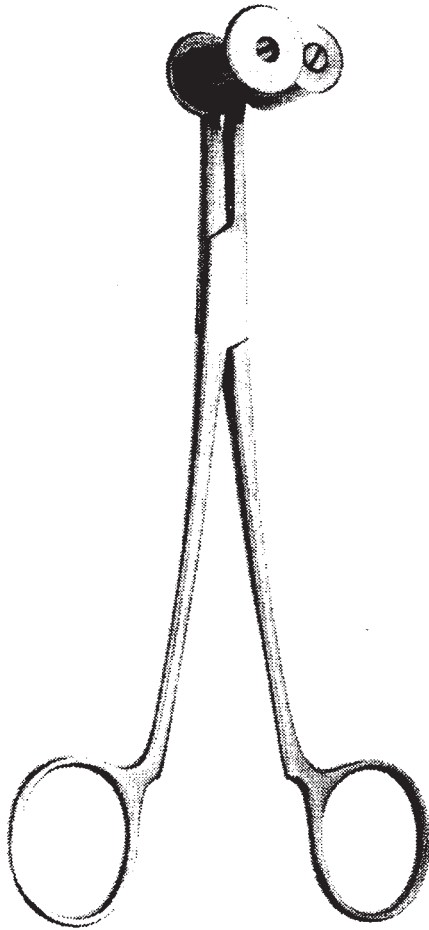

BÜLOW-GUNAR-HEY
13720-18 18 cm, 7"

Tuchklemmen
Towel Forceps
Pinzas de campos
Pinze fissateli



SCHAEDEL
15101-09
9 cm, 3 1/2"



JONES
15103-07
7 cm, 2 3/4"
15103-09
9 cm, 3 1/2"



JONES-CLIP
15105-09
9 cm, 3 1/2"

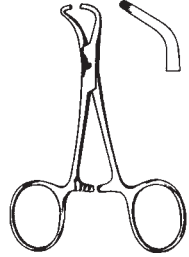

TOHUKU
15107-10 10 cm, 4"
15107-13 13 cm, 5 1/8"

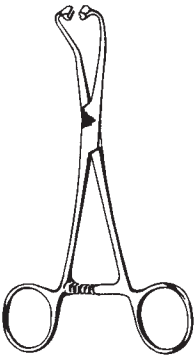

PEERS
15108-14
14,5 cm, 5 3/4"

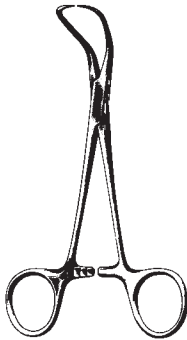

BACKHAUS
15111-09 9 cm, 3 1/2"
15111-11 11 cm, 4 3/8"
15111-13 13 cm, 5 1/8"
15111-15 15 cm, 6"



BACKHAUS-CLIP
15115-11
11 cm, 4 3/8"

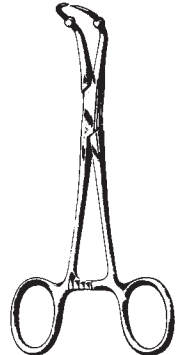

ROEDER
15117-13
13 cm, 5 1/8"

Tuchklemmen
Towel Forceps
Pinzas de campos
Pinze fissateli

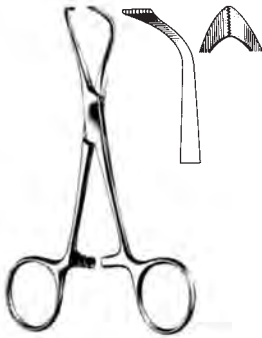

LORNA
15121-11 11 cm, 4 $\frac{3}{8}$ "
15121-13 13 cm, 5 $\frac{1}{8}$ "



BALL AND SOCKET
15123-11 11 cm, 4 $\frac{3}{8}$ "
15123-13 13 cm, 5 $\frac{1}{8}$ "



15125-14
14,5 cm, 5 $\frac{3}{4}$ "

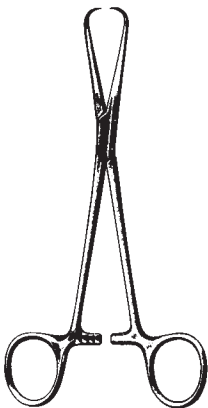

BERNHARD
15140-16
16,5 cm, 6 $\frac{1}{2}$ "

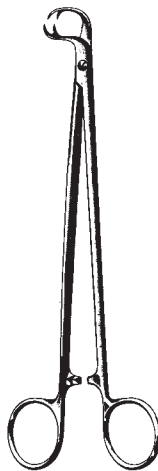

MOYNIHAN
15150-19
19 cm, 7 $\frac{1}{2}$ "



DOYEN
15161-18
18 cm, 7"

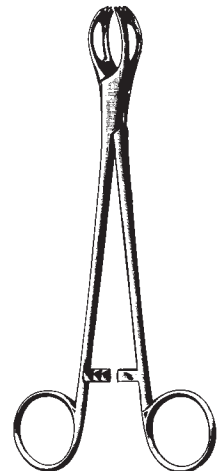

LANE
15164-15 15 cm, 6"
15164-20 20 cm, 8"

Tupferzangen
 Dressing Forceps
 Pinzas porta-esponjas
 Pinze per medicatura

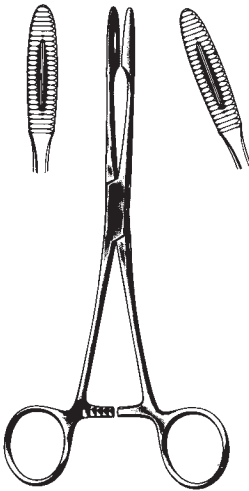

GROSS-MAIER
 17110-20 20 cm, 8" 17111-20
 17110-25 25 cm, 10" 17111-25

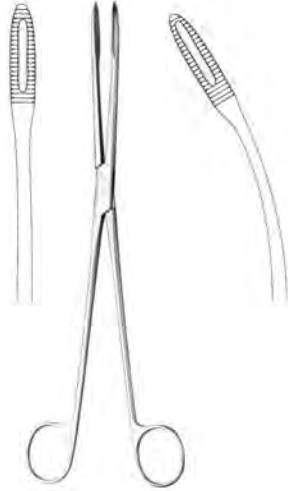

GROSS-MAIER
 17112-20 20 cm, 8" 17113-20
 17112-25 25 cm, 10" 17113-25

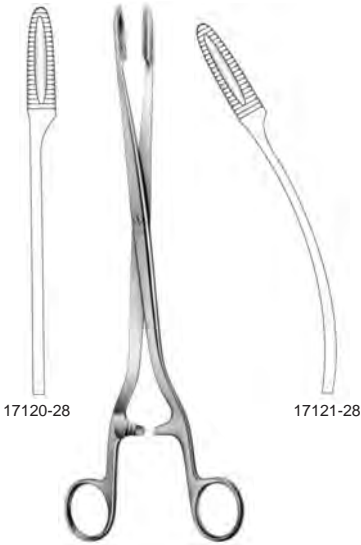

17120-28

17121-28

SIMS-MAIER
 28 cm, 11"



DUPLAY KORNZANGE
 17131-21 21 cm, 8 1/4"

Tupferzangen
 Dressing Forceps
 Pinzas porta-esponjas
 Pinze per medicatura



KORNZANGE
 17133-17 17 cm, 6 3/4"

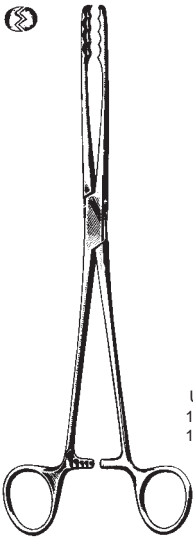

ULRICH
 17160-22
 17160-25



22 cm, 8 1/2"
 25 cm, 10"

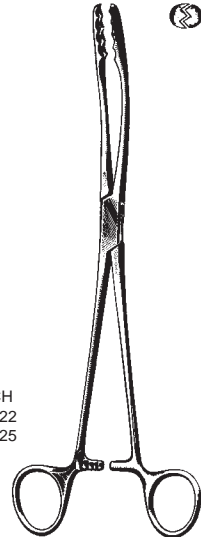

ULRICH
 17161-22
 17161-25

Tupferzange
 Sponge Holding Forceps
 Pinzas porta esponjas
 Pinze ad anelli per tamponi e spugne

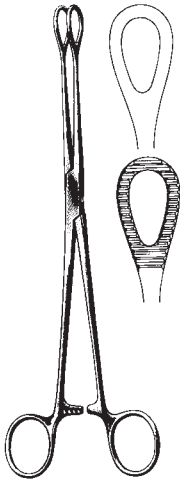

FOERSTER

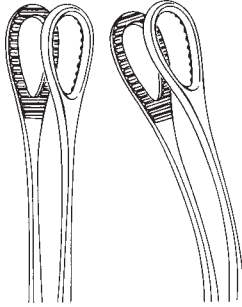

17170-18
 17170-20
 17170-25

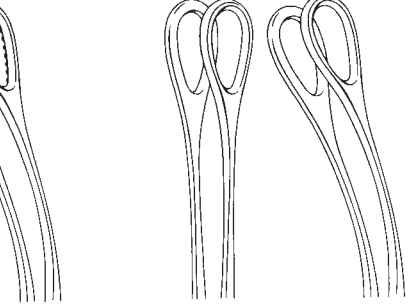

17171-18 18 cm, 7"
 17171-20 20 cm, 8"
 17171-25 25 cm, 10" 17172-18 17172-25 17173-18 17173-25

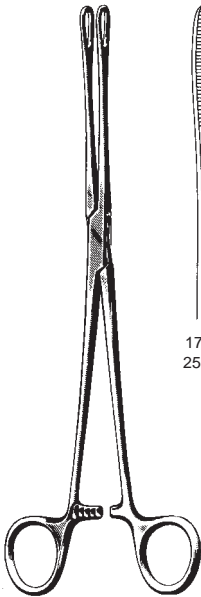

FOERSTER

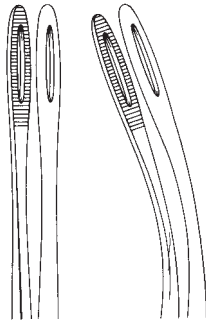

17174-25
 25 cm, 10"

17175-25
 25 cm, 10"

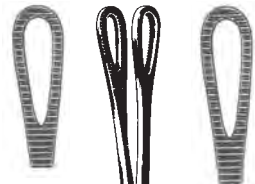

17180-18
 18 cm, 7"

17180-25
 25 cm, 10"

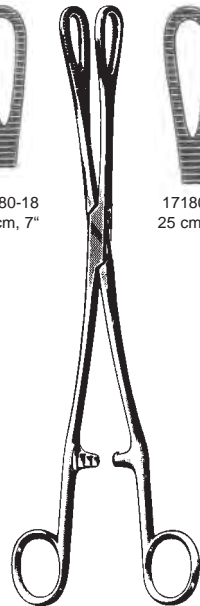

RAMPLEY

Tupferzangen
 Dressing Forceps
 Pinzas porta-esponjas
 Pinze per tamponi



BRYANT
 17207-13
 13 cm, 5 1/8"



LISTER (Sinus)
 17210-13 13 cm, 5 1/8"
 17210-16 16 cm, 6 1/4"
 17210-18 18 cm, 7"

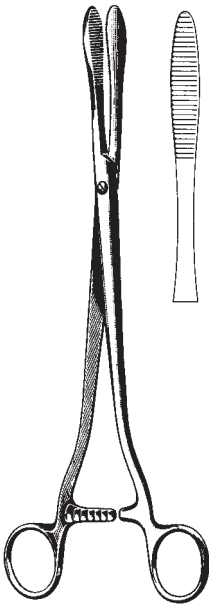

COLLIN
 17220-25 25 cm, 10"



PELKMANN
 17226-25 25 cm, 10"



CHERON
 17229-25 25 cm, 10"

Tamponzangen
Dressing Forceps
Pinzas para taponos
Pinze per tamponi

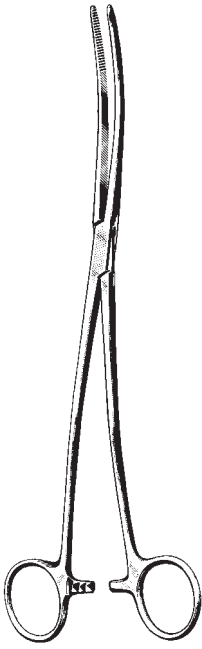

— BOZEMANN —
17230-26 17231-26
26 cm, 10 1/4"

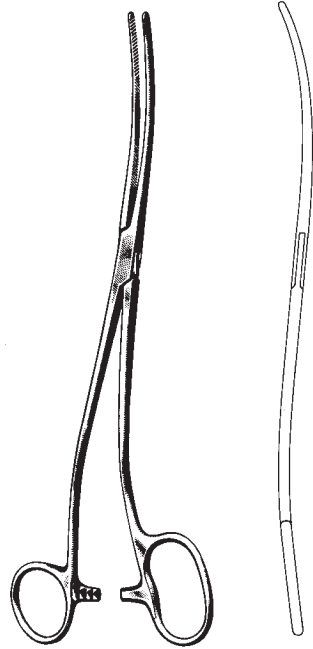

BOZEMANN-DOUGLAS
17233-26
26 cm, 10 1/4"

Wundhaken
Retractors
Separadores
Divaricatori

* Satz, set, juego, serie

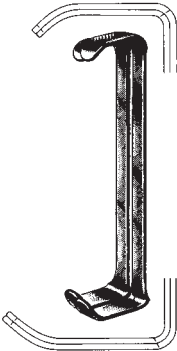

* FARABEU
19102-12
12 cm, 4 3/4"

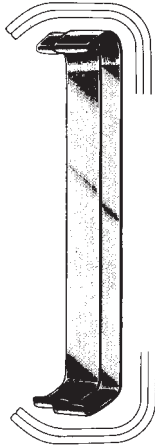

* FARABEU
19102-15
15 cm, 6"



COLLIN
19104-15
15 cm, 6"

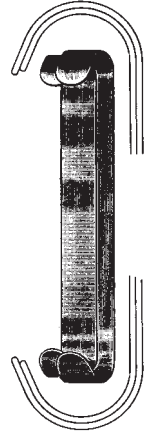

* PARKER
19110-13
13,5 cm, 5 1/4"

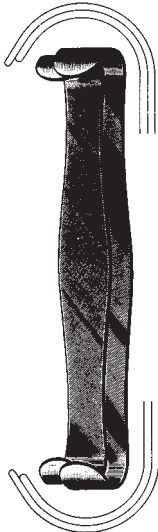

* PARKER
19110-18 18 cm, 7"

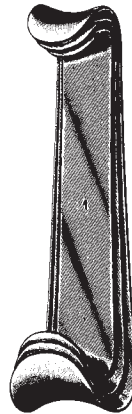

* ROUX
19120-00

Fig. 1 = 24x20 mm
Fig. 2 = 29x26 mm
Fig. 3 = 35x29 mm

Fig. 1 = 30x28 mm
Fig. 2 = 36x36 mm
Fig. 3 = 38x43 mm

19120-14 Fig. 1 14 cm, 5 1/2"
19120-15 Fig. 2 15 cm, 6"
19120-17 Fig. 3 17 cm, 6 3/4"

Wundhaken
 Retractors
 Separadores
 Divaricatori



ROUX BABY
 19122-13
 13 cm, 5 1/8"



LUER
 19123-11
 11 cm, 4 3/8"

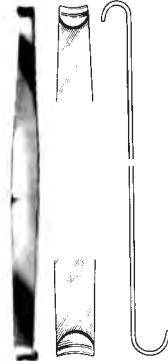

ROUX mini
 19124-15
 14 cm, 5 1/2"



RAGNELL
 19125-14
 14 cm, 5 1/2"



ROSE
 19126-13
 13 cm, 5 1/8"



CRILE
 19127-11
 11,5 cm, 4 1/2"

Wundhaken
Retractors
Separadores
Divaricatori

Fig. 2 = 25x24 mm
Fig. 1 = 21x24 mm

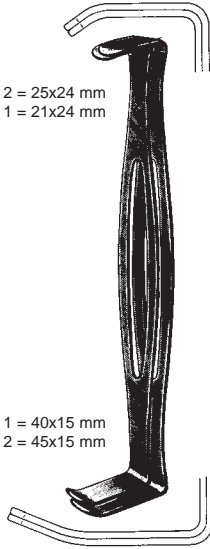

Fig. 1 = 40x15 mm
Fig. 2 = 45x15 mm

* US ARMY / Parker-Langenbeck
19131-21 21 cm, 8 1/4"



MAYO-COLLINS
19132-15
15 cm, 6"

Fig. 2 = 47x13 mm
Fig. 1 = 42x13 mm

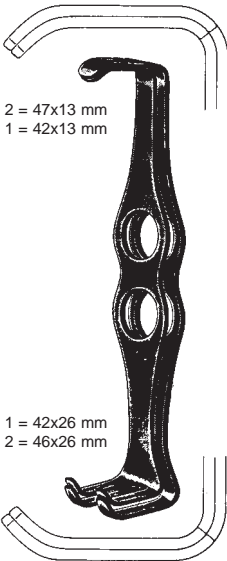
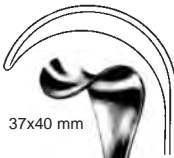

Fig. 1 = 42x26 mm
Fig. 2 = 46x26 mm

* MATHIEU
19134-20 20 cm, 8"



37x40 mm

30 x 31 mm

GOELET
19135-19 19 cm, 7 1/2"

52x33 mm



30x21 mm

COLLIN-HARTMANN
19137-16 16 cm, 6 1/4"

Wundhaken
Retractors
Separadores
Divaricatori

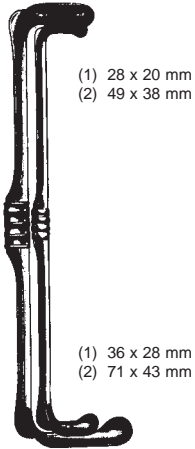

RICHARDSON-EASTMAN
(Set) 19140-00
(1) 19140-01 26 cm, 10 1/4"
(2) 19140-02 28 cm, 11"

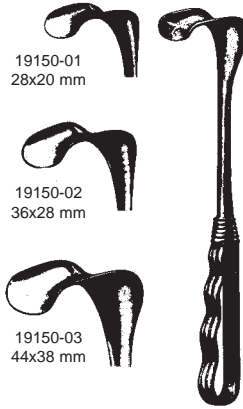

RICHARDSON
24 cm, 9 1/2"



RICHARDSON
19150-04
24 cm, 9 1/2"

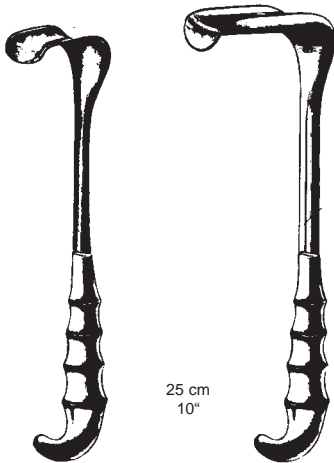

RICHARDSON GRIP
19152-25 20x25 mm
19152-31 25x31 mm
19152-38 38x38 mm
19152-51 19x51 mm
19152-64 41x64 mm

25 cm
10"

KELLY GRIP
19158-51 38x51 mm
19158-64 51x64 mm
19158-76 64x76 mm
19158-82 70x82 mm



KELLY
26 cm, 10 1/4"

Wundhaken, Bauch- und Darmspatel
 Retractors, abdominal and intestinal spatula
 Separadores, espátula intestinal y abdominal
 Divaricatori, spatole addominali e intestinali

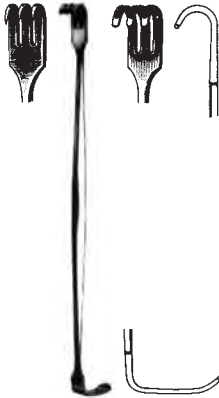

SENN-MILLER
 19160-17 17 cm, 6 3/4" 19161-17

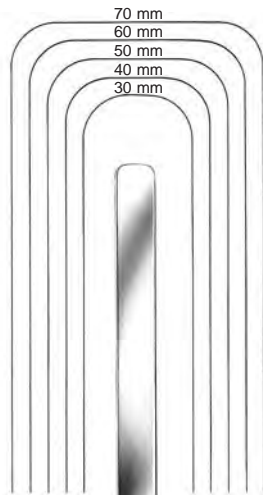

biegsam
 malleable
 maleable
 malleabili

biegsam, malleable, maleable, malleabili



RIBBON

- 19168-06 6x200 mm
- 19168-08 8x200 mm
- 19168-10 10x200 mm
- 19168-12 12x200 mm
- 19168-17 17x200 mm
- 19168-20 20x200 mm
- 19168-25 25x200 mm
- 19169-25 25x250 mm

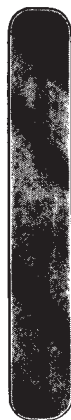

RIBBON

- 19170-20 20x330 mm
- 19170-25 25x330 mm
- 19170-32 32x330 mm
- 19170-40 40x330 mm
- 19170-45 45x330 mm
- 19170-50 50x330 mm
- 19170-65 65x330 mm
- 19170-76 76x330 mm



41 cm, 16"

- 19171-30 30 mm
- 19171-40 40 mm
- 19171-50 50 mm
- 19171-60 60 mm
- 19171-70 70 mm

Bauch- und Darmspatel
Abdominal and intestinal spatulas
Separadores, espátula intestinal y abdominal
Divaricatori, spatole addominali e intestinali

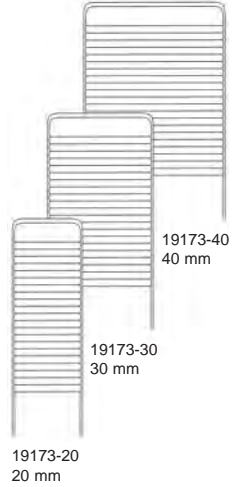

HABERER
19174-17 17/25x200 mm
19174-25 25/30x280 mm
19174-37 37/45x300 mm
19174-40 40/50x300 mm



REVERDIN
19175-28
28 cm, 11"

Bauch- und Darmspatel
 Abdominal and intestinal spatula
 Separadores, espátula intestinal y abdominal
 Divaricatori, spatole addominali e intestinali

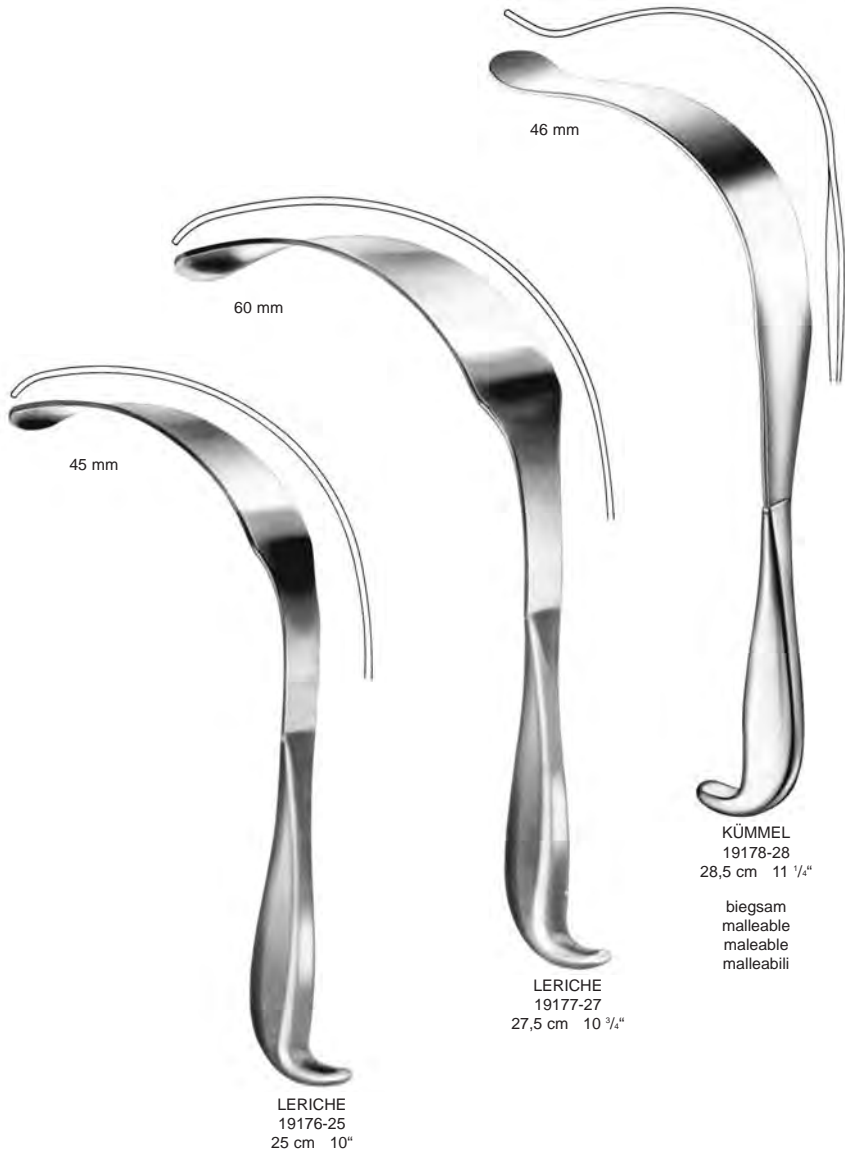

Bauchspatel
Abdominal Spatulas
Espátula abdominal
Spatola addominale



KÜMMEL
19179-28
31 cm 12 1/4"

Wundhaken
Retractors
Separadores
Divaricatori

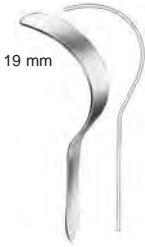

19 mm

DEAVER
19180-19
19 cm, 7 1/2"



22 mm

DEAVER
19181-22
21,5 cm, 8 1/2"



25 mm

DEAVER
19181-25
23 cm, 9"



25 mm

DEAVER
19183-25
30 cm, 11 3/4"



25 mm

DEAVER
19185-25
33 cm, 13"



25 mm

DEAVER
19187-25
36 cm, 14"

Wundhaken
 Retractors
 Separadores
 Divaricatori



38 mm

DEAVER
 19187-38 38x300 mm
 30 cm, 11 3/4"



50 mm

DEAVER
 19187-50 50x300 mm
 31 cm 12 1/4"



75 mm

DEAVER
 19187-75 75x300 mm
 32 cm, 12 1/2"



DEAVER GRIP
 19189-25 25x310 mm
 19189-38 38x310 mm
 19189-50 50x310 mm
 19189-75 75x310 mm
 31 cm 12 1/4"

Wundhaken
Retractors
Separadores
Divaricatori

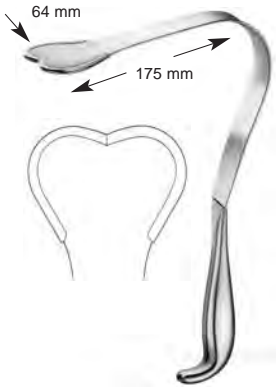

HARRINGTON-PEMBERTON
19190-64
29,5 cm 11 3/4"



HARRINGTON
19191-25 25x230 mm
19191-40 40x320 mm
19191-62 62x320 mm



TUFFIER
19192-23

Wundhaken
 Retractors
 Separadores
 Divaricatori

rechts
 right
 a la derecha
 a destra
 (45 mm x 48 mm)



COOLEY
 19195-01
 21,5 cm, 8 1/2"

rechts, gerieft
 right serrated
 a la derecha, estriado
 a destra, zigrinato
 (45 mm x 48 mm)



COOLEY
 19195-02
 21,5 cm, 8 1/2"

links
 left
 a la izquierda
 a sinistra
 (24 mm x 48 mm)



COOLEY
 19195-03
 23 cm, 9"

Hauthäkchen
Nerve and wound hooks
Ganchos y ganchitos para nervios
Uncini per nervi e divaricatori fini



GRAEFE
19210-12
scharf
sharp
agudo
acuto



GRAEFE
19211-12
stumpf
blunt
romo
smusso



12 cm, 4 3/4"



GUTHRIE
19212-01



GUTHRIE
19212-02

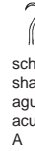

scharf
sharp
agudo
acuto
A

stumpf
blunt
romo
smusso
B

FRAZIER

- A 19214-13 13 cm, 5"
- A 19214-18 18 cm, 7"
- B 19215-13 13 cm, 5"
- B 19215-18 18 cm, 7"



LAHEY
12 cm, 4 3/4"



19215-01



19215-02



19215-03



JOSEPH
16 cm, 6 1/4"



19216-01



19216-02
2 mm



19216-05
5 mm



19216-07
7 mm



19216-10
10 mm



KLEINERT-KUTZ
13 cm, 5 1/4"



19217-03



19217-05



19217-07

Hauthäkchen
Nerve and wound hooks
Ganchos y ganchitos para nervios
Uncini per nervi e divaricatori fini

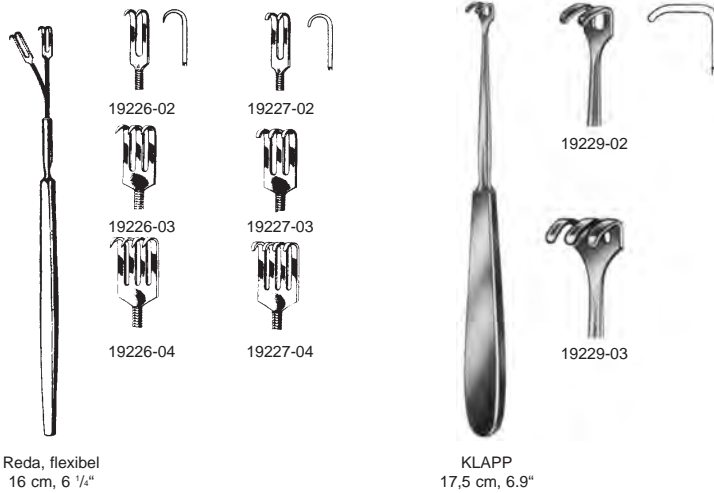
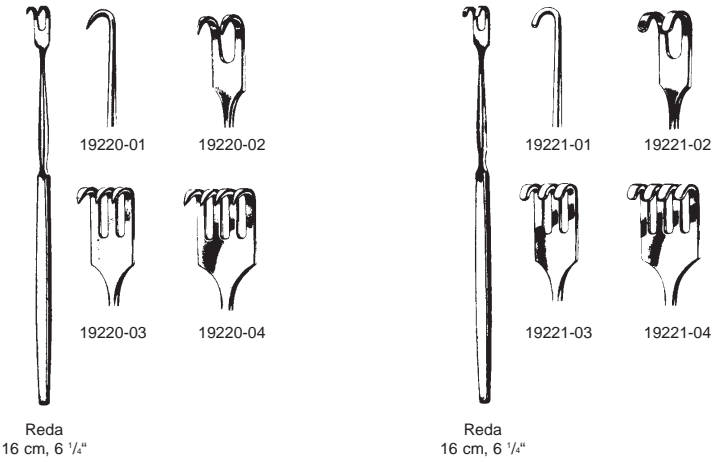

Wundhaken
Retractors
Separadores
Divaricatori

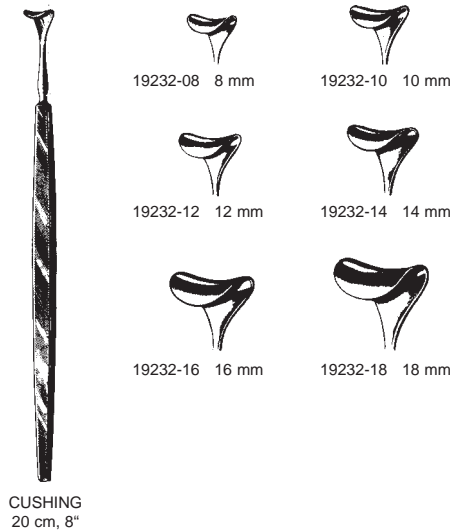
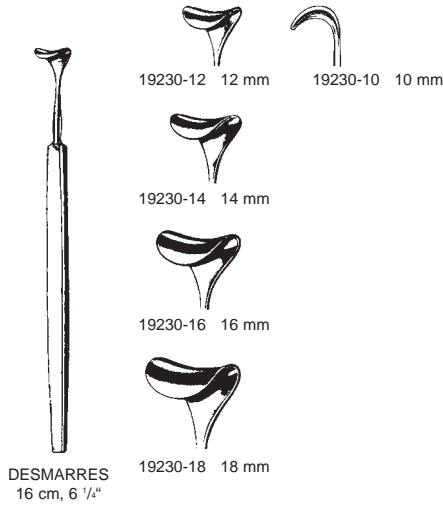

Wundhaken
Retractors
Separadores
Divaricatori



CUSHING
24 cm, 9 1/2"

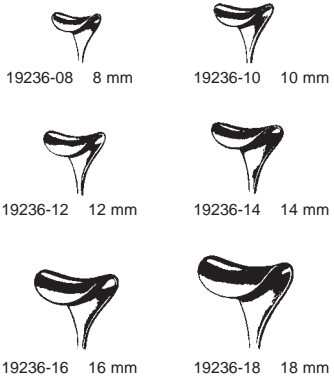

19236-08 8 mm 19236-10 10 mm
19236-12 12 mm 19236-14 14 mm
19236-16 16 mm 19236-18 18 mm



biegsam
malleable
maleable
malleabile

GIL-VERNET
19233-08 - 19233-23
24 cm, 9 1/2"

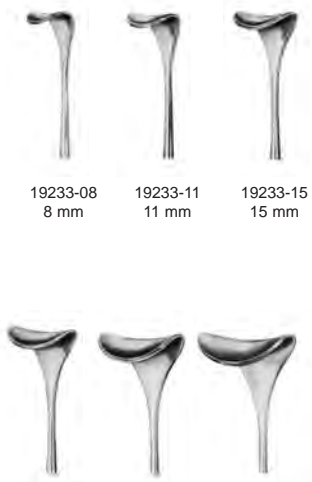

19233-08 8 mm 19233-11 11 mm 19233-15 15 mm
19233-17 17 mm 19233-20 20 mm 19233-23 23 mm

Wundhaken
Retractors
Separadores
Divaricatori



CUSHING
19234-20
20 cm, 8"



CUSHING
19235-21
21,5 cm, 8 1/2"



KÖNIG
18 cm, 7"



19236-01
13x13 mm



19236-02
12x16 mm



SENN-GREEN
15 cm, 6"



19240-10 10x6 mm



19240-20 20x6 mm



19250-16
16x6 mm

19250-24
24x6 mm

LANGENBECK-GREEN
16 cm, 6 1/4"

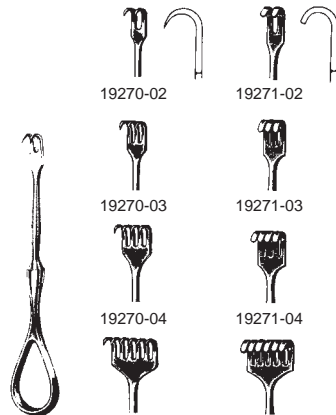

19270-02

19271-02

19270-03

19271-03

19270-04

19271-04

19270-06

19271-06

VOLKMANN
11,5 cm, 4 1/2"

Wundhaken
 Retractors
 Separadores
 Divaricatori

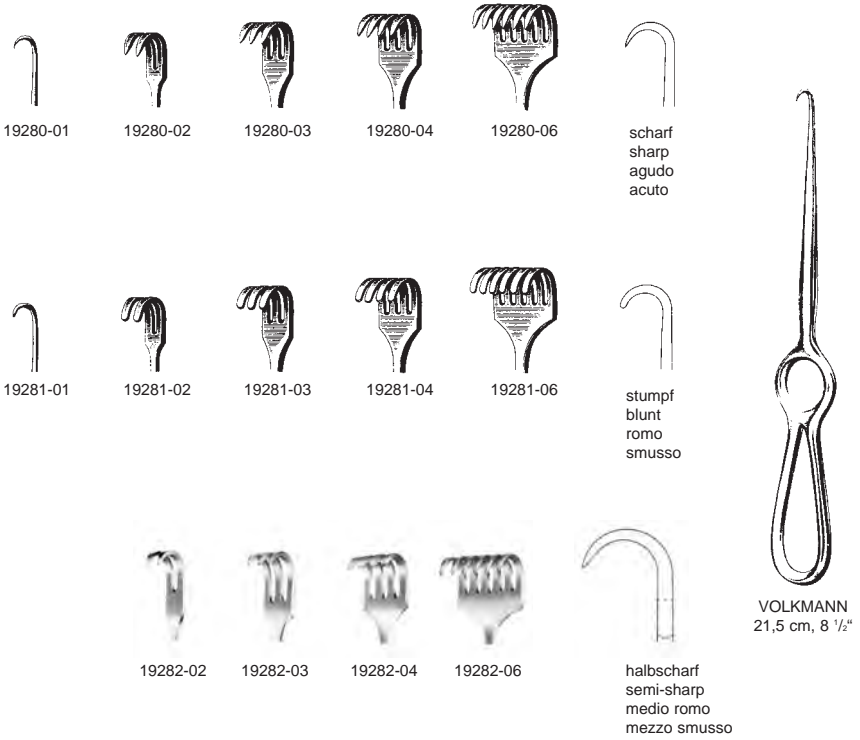

Wundhaken
Retractors
Separadores
Divaricatori



19296-01



19296-02



19296-03



19296-04



19296-06



19296-08



19297-01



19297-02



19297-03



19297-04



19297-06



19297-08



KOCHER
19296-01 - 19297-08
22 cm, 8 3/4"

Wundhaken, Knochenhaken
 Retractors, Bone Retractors
 Separadores, Separadores oseos
 Divaricatori, Divaricatori per ossa

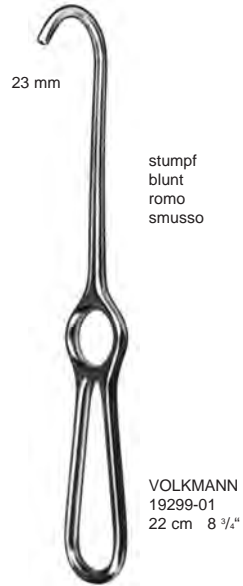
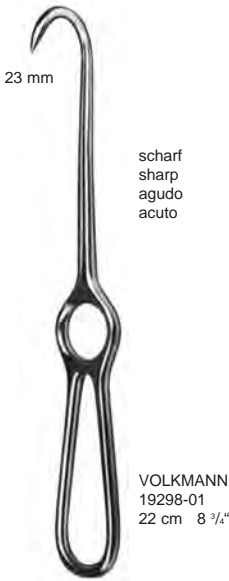

Zähne
teeth
dientes
denti

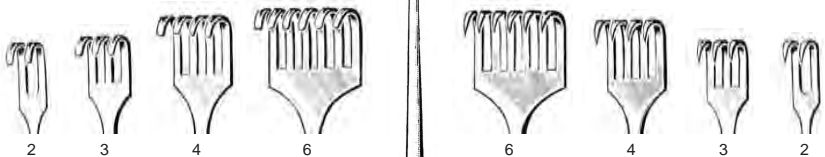

stumpf
blunt
romo
smusso

- 19301-02 8x 8 mm
- 19301-03 8x13 mm
- 19301-04 8x18 mm
- 19301-06 8x28 mm

scharf
sharp
agudo
acuto

- 19300-02 8x 8 mm
- 19300-03 8x13 mm
- 19300-04 8x18 mm
- 19300-06 8x28 mm

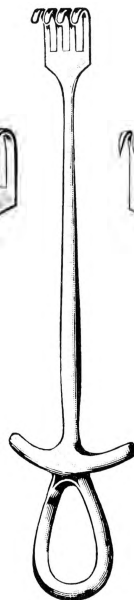

Wundhaken
Retractors
Separadores
Divaricatori



MEYERDING
18 cm, 7"



19302-01 18x7 mm



19302-04 7x4 mm



19302-02 16x5 mm



19302-05 10x3 mm



19302-03 7x4 mm



19302-06 10x4 mm

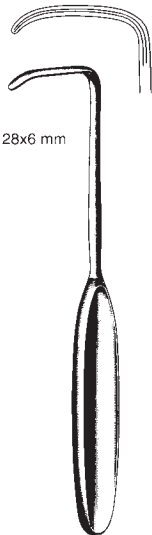

28x6 mm

LAHEY
19304-19
19 cm, 7 1/2"



12x14 mm

LITTLE
19306-20
20 cm, 8"



STRANDELL-STILLE
17 cm 6 3/4"



19307-01

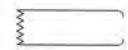

19307-02

Wundhaken
Retractors
Separadores
Divaricatori

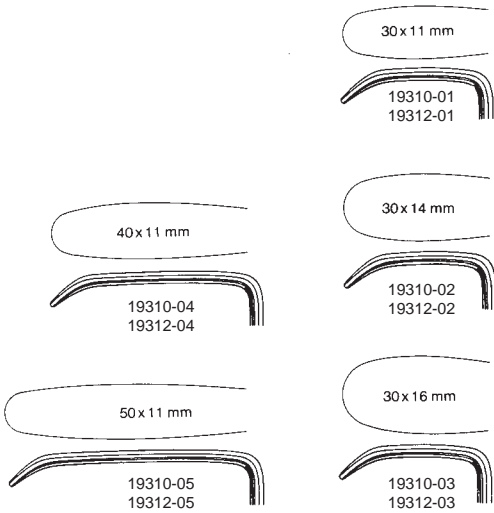

LANGENBECK
19310-01 - 19310-05
22 cm, 8 3/4"



LANGENBECK
19312-01 - 19312-05
21 cm, 8 1/4"

Wundhaken
Retractors
Separadores
Divaricatori

- 19314-07 35x 7 mm
- 19314-10 35x10 mm
- 19314-12 80x12 mm
- 19314-14 70x14 mm
- 19314-15 35x15 mm
- 19314-16 80x16 mm
- 19314-20 60x20 mm
- 19315-06 25x 6 mm
- 19330-40 40x12 mm
- 19330-55 55x11 mm

KOCHER-LANGENBECK
19314-07 - 19314-20
21 cm, 8 1/4"

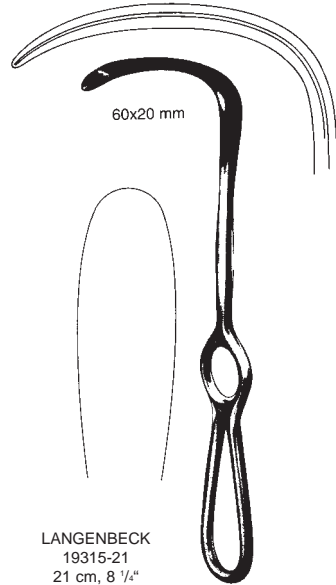
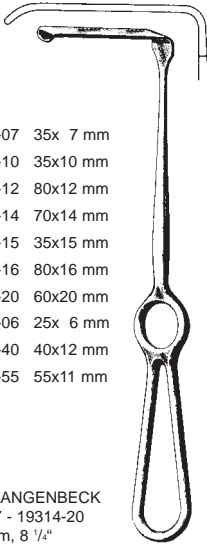

LANGENBECK
19315-21
21 cm, 8 1/4"



LANGENBECK
19317-21
21 cm, 8 1/4"

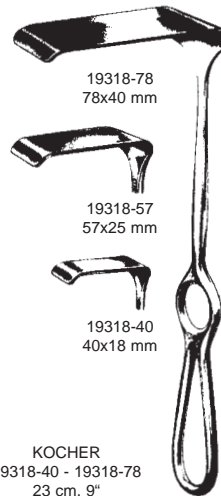

KOCHER
19318-40 - 19318-78
23 cm, 9"

Wundhaken
 Retractors
 Separadores
 Divaricatori



19344-14
 14x17 mm
 21,5 cm, 8 1/2"



19344-20
 20x22 mm
 22 cm, 8 3/4"



19344-26
 26x30 mm
 23,5 cm, 9 1/4"



MIDDELDORF
 19344-14 - 19344-26



KOCHER
 19340-10 40x10 mm
 19340-15 40x15 mm
 19340-20 40x20 mm
 22 cm, 8 3/4"

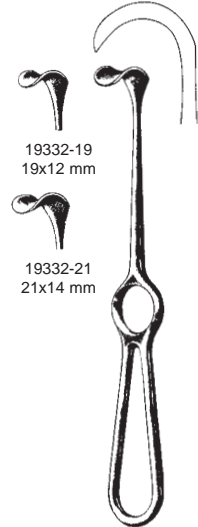

19332-19
 19x12 mm

19332-21
 21x14 mm

KOCHER
 19332-19 - 19332-21
 19 cm, 7 1/2"



MIDDELDORF
 19345-01 45x45 mm
 25,5 cm, 10"



19345-02
 45x50 mm



19345-03
 55x70 mm



GREEN
 19348-22
 22 cm, 8 3/4"

Wundhaken
Retractors
Separadores
Divaricatori



35 x 8 mm

ZENKER
19350-35
25 cm, 10"



60 x 12 mm

ZENKER
19350-60
26 cm, 10 1/4"



75 x 12 mm

ZENKER
19350-70
27,5 cm, 10.8"

Wundhaken
Retractors
Separadores
Divaricatori



4 Zähne
4 teeth
4 dientes
4 denti



5 Zähne
5 teeth
5 dientes
5 denti

19364-50 45x50 mm

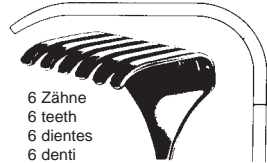

6 Zähne
6 teeth
6 dientes
6 denti

19364-60 50x60 mm

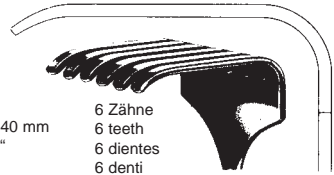

6 Zähne
6 teeth
6 dientes
6 denti

19364-70 70x70 mm

ISRAEL
19364-40 40X40 mm
25 cm, 10"

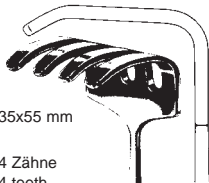

35x55 mm

4 Zähne
4 teeth
4 dientes
4 denti

OLLIER

19360-04 22,5 cm, 8.9"



40x30 mm

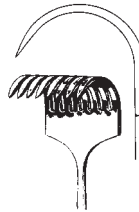

8 Zähne
8 teeth
8 dientes
8 denti

spitz
sharp
agudo
acuto

stumpf
blunt
romo
smusso

KOERTE

19366-08 23,5 cm, 9 1/4" 19367-08

Wundhaken
Retractors
Separadores
Divaricatori

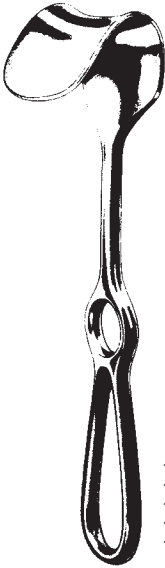

FRITSCH
19370-40 45x40 mm
19370-50 45x50 mm
19370-60 45x60 mm
19370-75 45x75 mm
19370-85 65x85 mm
24 cm, 9 1/2"



KOCHER
19372-22
70x25 mm
22,5 cm, 8.9"



KOCHER
19374-45 80x45 mm
19374-55 80x55 mm
19374-65 80x65 mm
25 cm, 10"



DOYEN
19378-25
25 cm, 10"

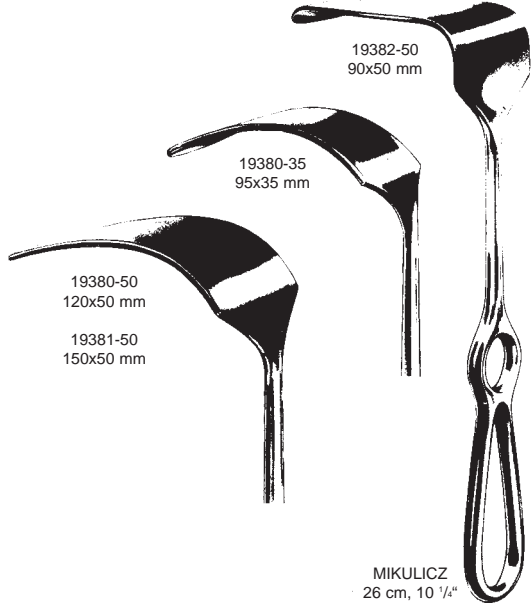

MIKULICZ
26 cm, 10 1/4"

50x85 mm

19382-50
90x50 mm

19380-35
95x35 mm

19380-50
120x50 mm

19381-50
150x50 mm

Wundhaken
Retractors
Separadores
Divaricatori



19388-40 70x40 mm
19388-50 70x50 mm
19388-65 70x65 mm

MORRIS
24,5 cm
9 3/4"

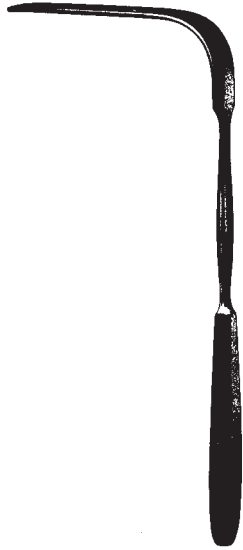

SIMON
19480-22 115x22 mm
19480-27 115x27 mm
28 cm, 11"

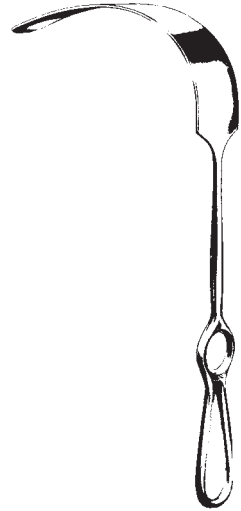

KELLY
19385-38 160x38 mm
19385-57 160x57 mm
27 cm, 10 1/2"



19482-82
82x28 mm



19482-73
73x28 mm



19482-45
45x25 mm

HEANEY
19482-45 - 19482-82
27 cm, 10 1/2"

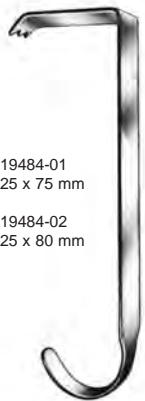

19484-01
25 x 75 mm
19484-02
25 x 80 mm

HIBBS
24 cm, 9 1/2"



125x37 mm

SAUERBRUCH
19492-25
25 cm, 10"

Wundhaken
Retractors
Separadores
Divaricatori

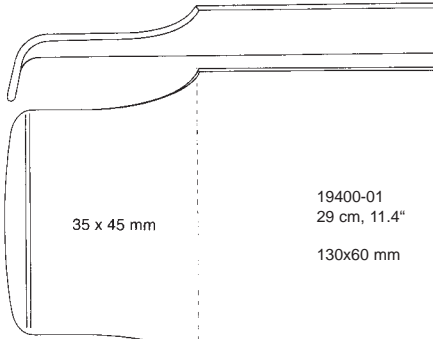

19400-01
29 cm, 11.4"
130x60 mm

Pelvis-Haken
Pelvis retractor
Retractor de pelvis
Divaricatori pelvici

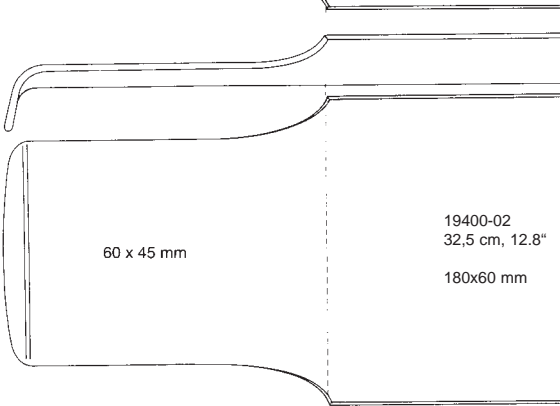

19400-02
32,5 cm, 12.8"
180x60 mm

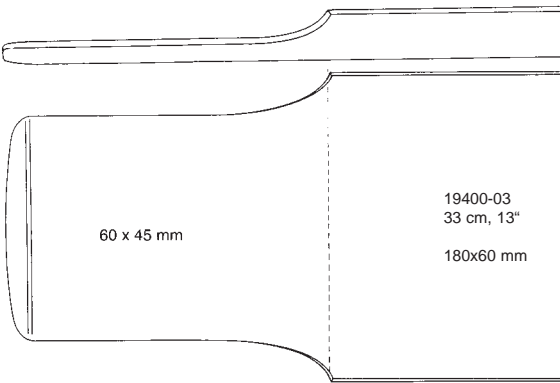

19400-03
33 cm, 13"
180x60 mm



ST. MARKS
19400-01 19400-03

Wundhaken
 Retractors
 Separadores
 Divaricatori

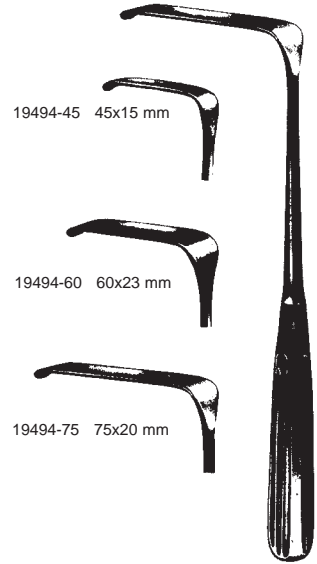
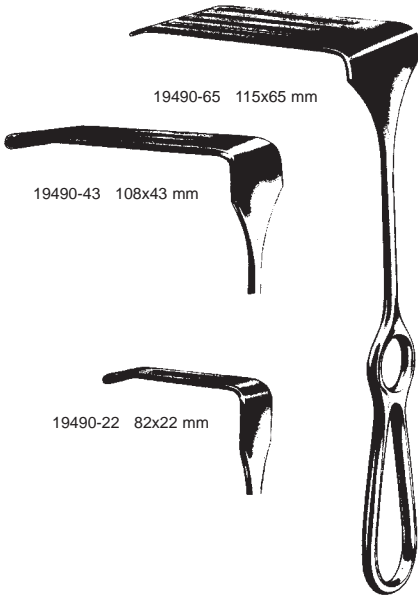

CORYLLOS (Thorax)
 19490-22 - 19490-65
 24 cm, 9 1/2"

SAUERBRUCH
 19494-45 - 19494-75
 22,5 cm, 8,9"



DAVIDSON (Scapula)
 19496-50 75x50 mm



DAVIDSON (Scapula)
 19496-90 75x90 mm

Wundhaken
Retractors
Separadores
Divaricatori

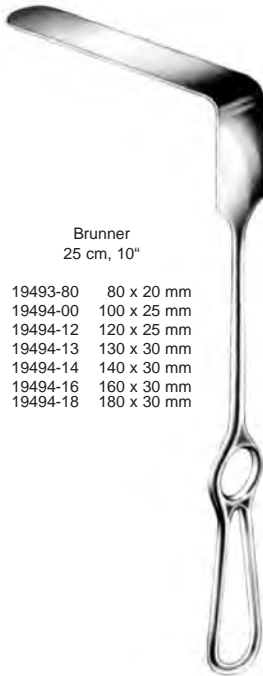

Brunner
25 cm, 10"

19493-80	80 x 20 mm
19494-00	100 x 25 mm
19494-12	120 x 25 mm
19494-13	130 x 30 mm
19494-14	140 x 30 mm
19494-16	160 x 30 mm
19494-18	180 x 30 mm

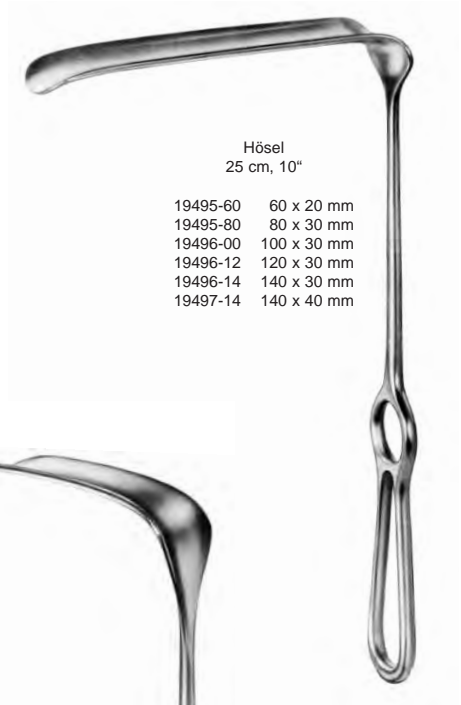

Hösel
25 cm, 10"

19495-60	60 x 20 mm
19495-80	80 x 30 mm
19496-00	100 x 30 mm
19496-12	120 x 30 mm
19496-14	140 x 30 mm
19497-14	140 x 40 mm



Doyen-Stille
25 cm, 10"

19498-01	97 x 29 mm
19498-02	101 x 31 mm
19498-03	127 x 52 mm

Wundsperrer
 Retractors
 Separadores
 Divaricatori

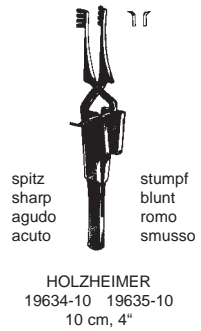
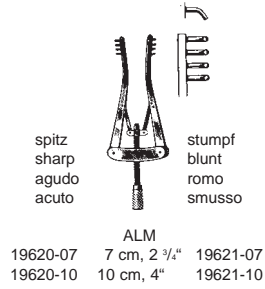
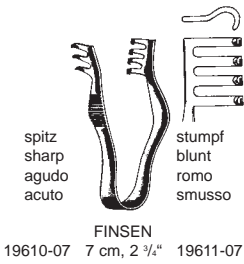

Wundsperrer
Retractors
Separadores
Divaricatori

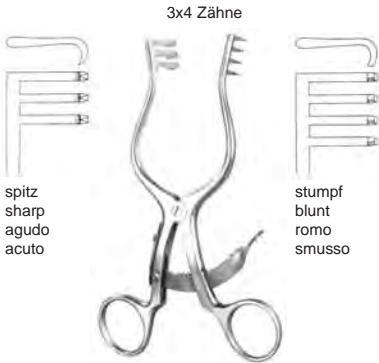

SCALP-CONTOUR
19640-14 - 19641-14
13,5 cm, 5 1/4"

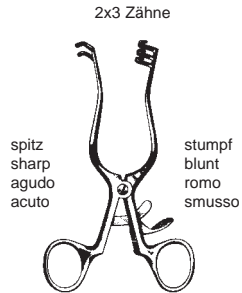

WEITLANER
19650-10 19651-10
11,5 cm, 4 1/2"

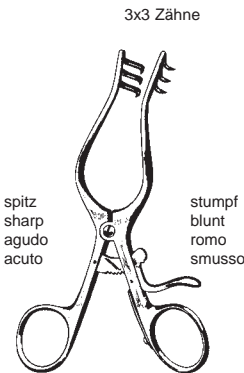

WEITLANER-WULLSTEIN
19654-13 19655-13
13 cm, 5 1/8"

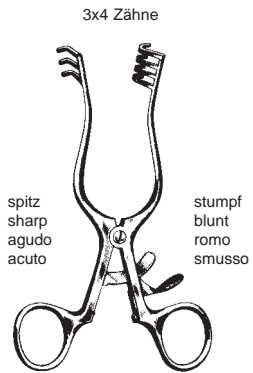

WEITLANER
19670-14 14,0 cm, 5 1/2" 19671-14
19670-16 16,5 cm, 6 1/2" 19671-16
19670-20 20,0 cm, 8" 19671-20
19670-24 24,0 cm, 9 1/2" 19671-24

Wundsperrer
 Retractors
 Separadores
 Divaricatori

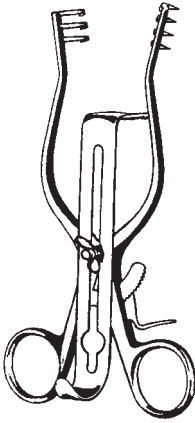

HENLEY
 19675-00 - 19677-32
 16,5 cm, 6 1/2"

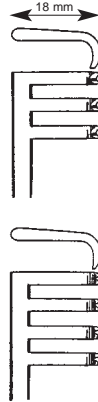

19675-00 komplett, stumpf, 3x4 Z. und 3 Valven
 19675-00 complete, blunt, 3x4 teeth and 3 blades
 19675-00 completo, romo, 3x4 dientes y 3 valvas
 19675-00 completo, smusso, 3x4 d. e 3 valve

19676-00 komplett, scharf, 3x4 Z. und 3 Valven
 19676-00 complete, sharp, 3x4 teeth and 3 blades
 19676-00 complete, agudo, 3x4 dientes y 3 valvas
 19676-00 completo con retr. acuto 3x4 d. e 3 valve

19678-05 Retraktor allein, stumpf 3x4 Zähne
 19678-05 Retractor only, blunt 3x4 teeth
 19678-05 Separador solo, romo, 3x4 dientes
 19678-05 Retratore solo, smusso 3x4 denti

19678-06 Retraktor allein, spitz 3x4 Zähne
 19678-06 Retractor only, sharp 3x4 teeth
 19678-06 Separador solo, agudo, 3x4 dientes
 19678-06 Retratore solo, acuto 3x4 denti



19677-19
 16x19 mm
 5/8" x 3/4"

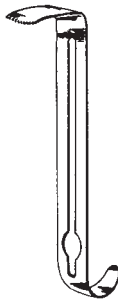

19677-25
 16x25 mm
 5/8" x 1"

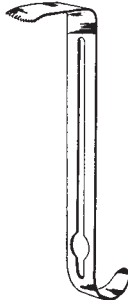

19677-32
 16x32 mm
 5/8" x 1 1/4"

Wundsperrer
Retractors
Separadores
Divaricatori



PLESTER

19672-11 11 cm, 4 3/8"
stumpf - blunt - romo - smusso



PLESTER

19673-11 11 cm, 4 3/8"
stumpf - blunt - romo - smusso

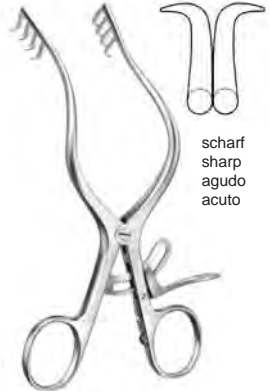

scharf
sharp
agudo
acuto

MOLLISON

19674-15 15 cm, 6"



WULLSTEIN
19675-13
13 cm, 5 1/8"



PLESTER
19677-13
13 cm, 5 1/8"

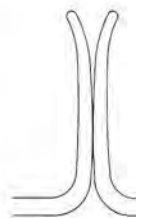

MAYO-ADAMS
19678-16
16,5 cm, 6 1/2"

Wundsperrer
 Retractors
 Separadores
 Divaricatori

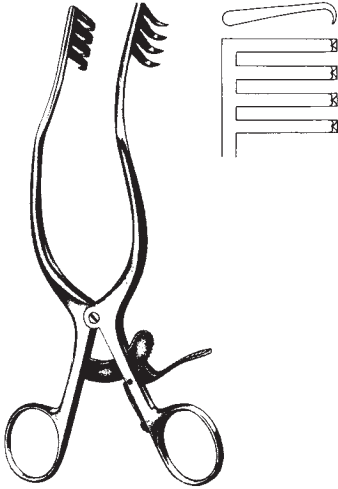

ANDERSON ADSON
 19679-20 19,5 cm, 7 3/4"



NORFOLK / NORWICH
 19679-22 22 cm, 8 3/4"

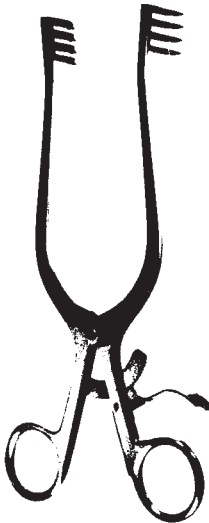

ADSON
 19680-19 19 cm, 7 1/2" 19681-19

spitz
 sharp
 agudo
 acuto

stumpf
 blunt
 romo
 smusso



TRAVERS
 19681-21 21,5 cm, 8 1/2"

Wundsperrer
Retractors
Separadores
Divaricatori

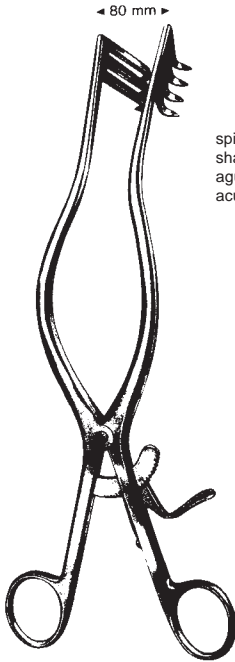

ADSON
19682-26 - 19683-26
26,5 cm, 10 1/2"

spitz
sharp
agudo
acuto

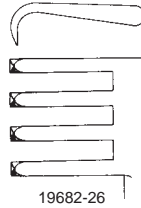

19682-26

stumpf
blunt
romo
smusso

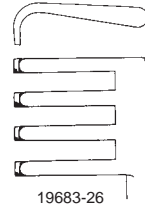

19683-26

- 19684-14 14 cm, 5 1/2"
- 19684-16 16 cm, 6 1/4"
- 19684-20 20 cm, 8"
- 19684-26 26 cm, 10 1/4"

spitz
sharp
agudo
acuto

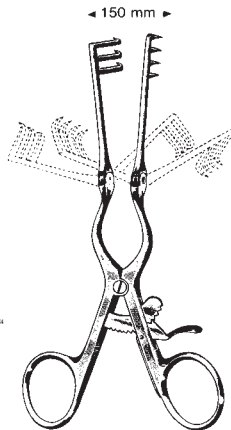

ADSON

- 19685-14 14 cm, 5 1/2"
- 19685-16 16 cm, 6 1/4"
- 19685-20 20 cm, 8"
- 19685-26 26 cm, 10 1/4"

stumpf
blunt
romo
smusso

Wundsperrer
Retractors
Separadores
Divaricatori

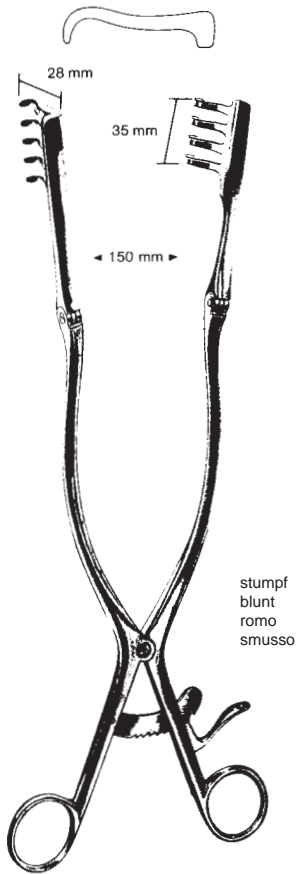

ADSON
19686-32
32 cm, 12 3/4"

Wundsperrer
Retractors
Separadores
Divaricatori



Beckman-Adson
31 cm, 12 1/4"

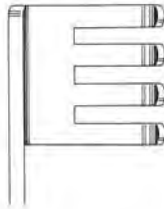

19687-01
25 x 27 mm

stumpf
blunt
romo
smusso

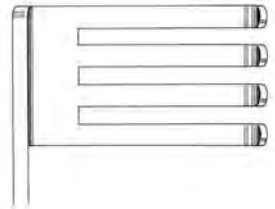

19688-01
45 x 27 mm

stumpf
blunt
romo
smusso

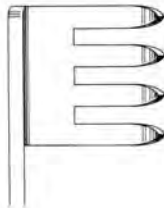

19687-02
25 x 27 mm

scharf
sharp
agudo
acuto

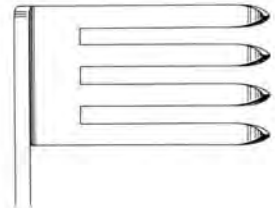

19688-02
45 x 27 mm

scharf
sharp
agudo
acuto

Wundsperrer
 Retractors
 Separadores
 Divaricatori



MARTIN
 28,5 cm, 11 1/4"

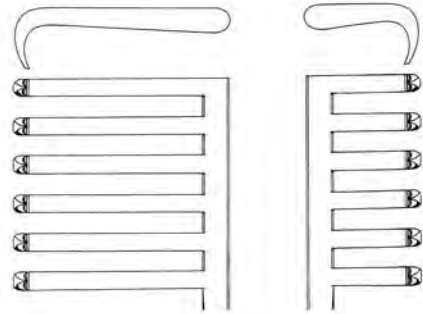

19689-01
 6x6 Zähne

scharf, lange Zähne links
 sharp, long teeth on left side
 agudo, dientes largos a la izquierda
 acuto, denti lunghe a sinistra

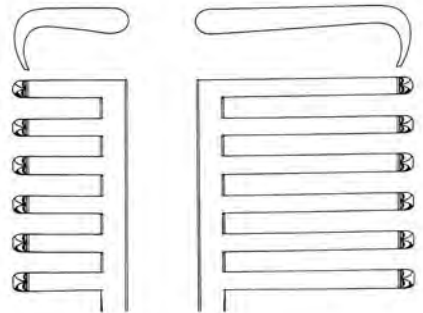

19689-02
 6x6 Zähne

scharf, lange Zähne rechts
 sharp, long teeth on right side
 agudo, dientes largos a la derecha
 acuto, denti lunghe a destra

Wundsperrer
 Retractors
 Separadores
 Divaricatori

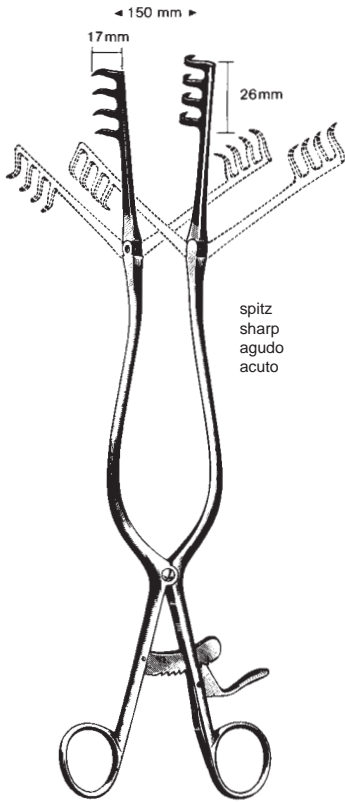

BECKMANN
 19690-31
 31 cm, 12 1/4"

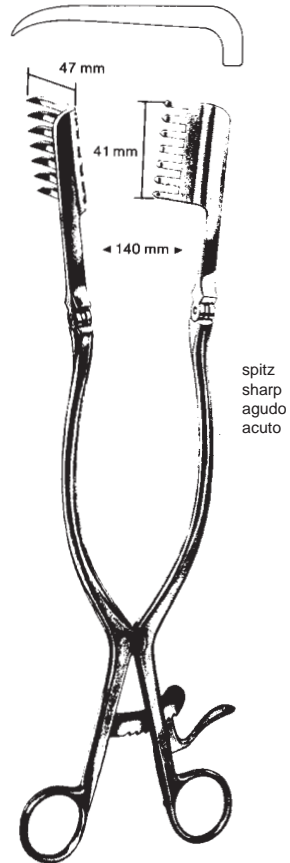

BECKMANN-EATON
 19692-32
 32 cm, 12 1/4"

Wundhaken
Retractors
Separadores
Divaricatori



19694-01
50 x 16 mm
20 cm, 8"



19694-02
75 x 25 mm
23 cm, 9"



19694-03
90 x 50 mm
24 cm, 9 1/2"

MEYERDING

Wundsperrer
Retractors
Separadores
Divaricatori

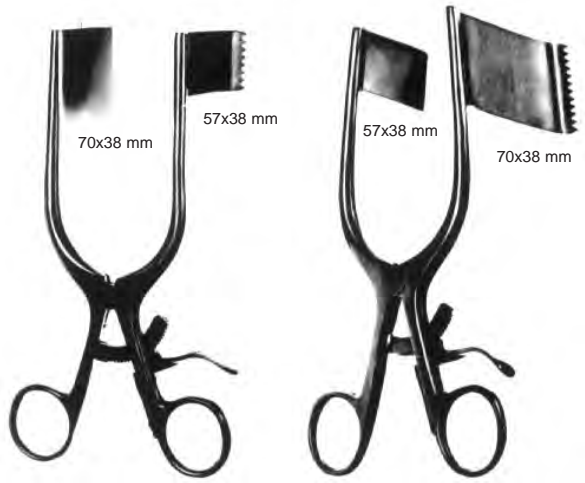

DARLING
19696-18 18 cm, 7"

DARLING
19698-18 18 cm, 7"



CLOWARD
25 cm, 10"

19710-01



CLOWARD
16 cm, 6 1/4"

19711-01

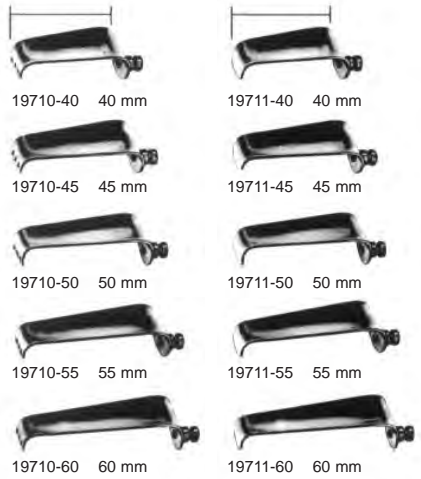

19710-40 40 mm

19711-40 40 mm

19710-45 45 mm

19711-45 45 mm

19710-50 50 mm

19711-50 50 mm

19710-55 55 mm

19711-55 55 mm

19710-60 60 mm

19711-60 60 mm

19710-00
Sperrer komplett mit 5 Valven spitz
Retractor complete with 5 blades sharp
Separador completo con 5 valvas agudas
Divaricatore completo con 5 valve acute

19711-00
Sperrer komplett mit 5 Valven spitz
Retractor complete with 5 blades sharp
Separador completo con 5 valvas agudas
Divaricatore completo con 5 valve acute

19712-00
Sperrer komplett mit 5 Valven stumpf
Retractor complete with 5 blades blunt
Separador completo con 5 valvas romas
Divaricatore completo con 5 valve smusse

19713-00
Sperrer komplett mit 5 Valven stumpf
Retractor complete with 5 blades blunt
Separador completo con 5 valvas romas
Divaricatore completo con 5 valve smusse

Laminektomie-Wundspreizer
Retractors, Cervical Spine
Separadores, columna vertebral
Divaricatori, spina cervicale



CASPAR
19720-00 compl.
(5 valven, 5 valvas, 5 blades, 5 valvas, 5 valve)
19720-15
ohne Blätter, without blades, sin valvas, senza valve



CASPAR
19721-00 compl.
(5 valven, 5 valvas, 5 blades, 5 valvas, 5 valve)
19721-15
ohne Blätter, without blades, sin valvas, senza valve



CASPAR
19724-00 compl. (5 valven, 5 valvas, 5 blades, 5 valvas, 5 valve)
19724-11 ohne Blätter, without blades, sin valvas, senza valve



medial

CASPAR
19724-40 40x20 mm
19724-45 45x20 mm
19724-50 50x20 mm
19724-55 55x20 mm
19724-60 60x20 mm



lateral

CASPAR
19725-40 40x20 mm
19725-45 45x20 mm
19725-50 50x20 mm
19725-55 55x20 mm
19725-60 60x20 mm

Laminektomie-Wundspreizer
 Retractors
 Separadores
 Divaricatori



19745-40 40 mm



19745-45 45 mm



19745-50 50 mm



19745-55 55 mm



19745-60 60 mm



19745-65 65 mm



19745-70 70 mm

CASPAR
 19744-00 compl. incl. 7 Blätter, compl. incl. 7 blades, valvas, valva
 19744-17 ohne Blätter, without blades, sin valvas, senza valve



19747-45 45 mm

19747-50 50 mm

19747-55 55 mm

19747-60 60 mm

19747-65 65 mm



CASPAR
 19747-45 - 19747-65

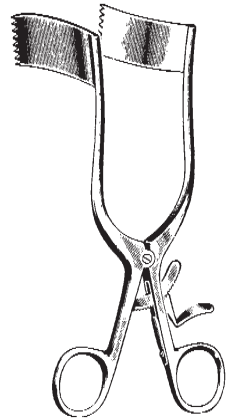

MEYERDING
 17 cm, 6 3/4"

- 19748-01 2,5 x 3,2 cm
- 19748-02 2,5 x 5,4 cm
- 19748-03 1,9 x 6,0 cm
- 19748-04 2,5 x 6,0 cm

Bauchdeckenhalter
 Abdominal Retractors
 Separadores abdominales
 Divaricatori addominali

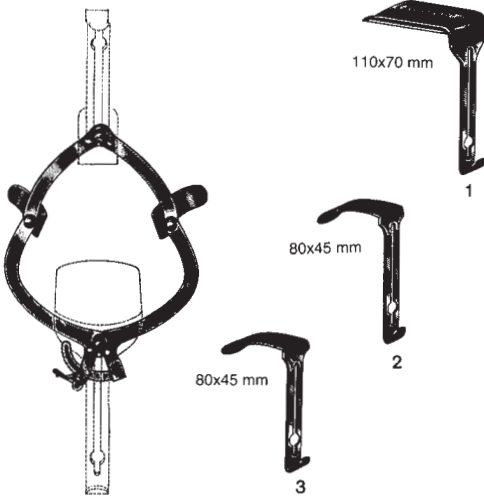

O'SULLIVAN - O'CONNOR
 19754-00
 compl.

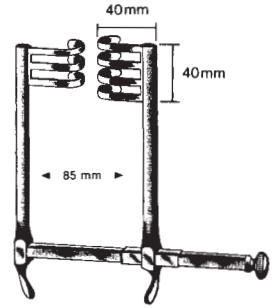

FRAZIER
 19758-85

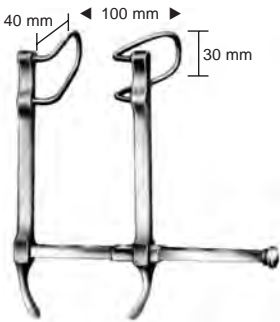

BABY GOSSET
 19759-00

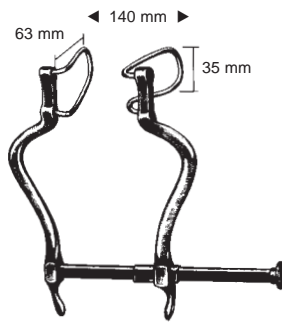

GOSSET
 19760-14

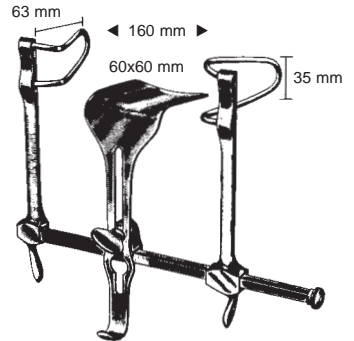

GOSSET
 19762-16

Bauchdeckenhalter
 Abdominal Retractors
 Separadores abdominales
 Divaricatori addominali

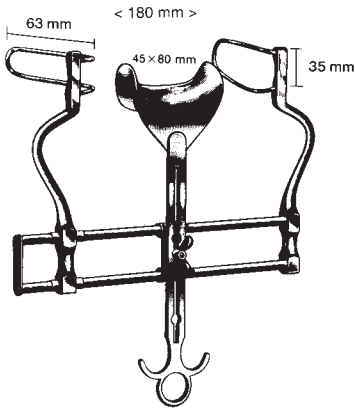

BALFOUR
 19764-18
 18 cm, 7"

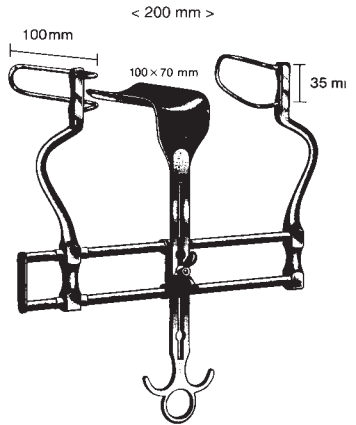

BALFOUR
 19764-20
 20 cm, 8"

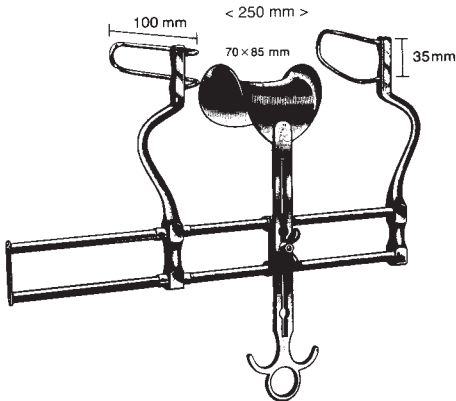

BALFOUR
 19764-25
 25 cm, 10"

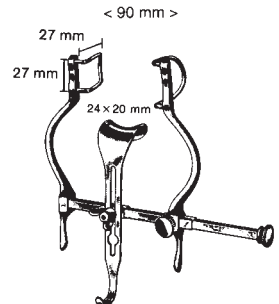

BALFOUR Baby
 19766-90
 9 cm, 3 1/2"

Bauchdeckenhalter
 Abdominal Retractors
 Separadores abdominales
 Divaricatori addominali

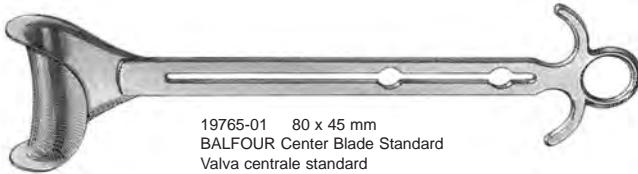

19765-01 80 x 45 mm
 BALFOUR Center Blade Standard
 Valva centrale standard
 Valva central estándar

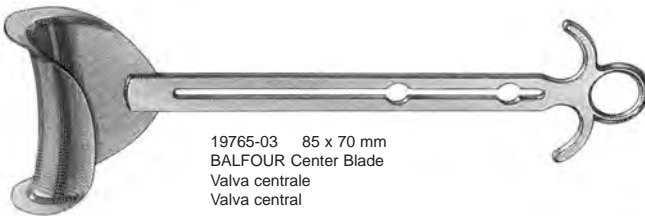

19765-03 85 x 70 mm
 BALFOUR Center Blade
 Valva centrale
 Valva central

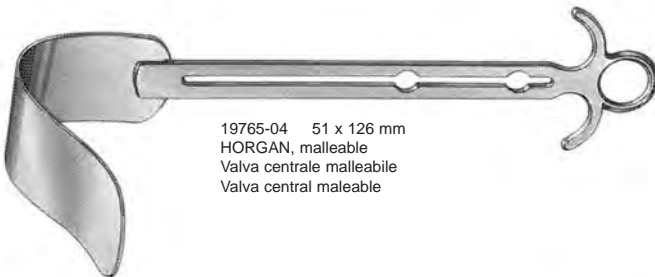

19765-04 51 x 126 mm
 HORGAN, malleable
 Valva centrale malleabile
 Valva central maleable

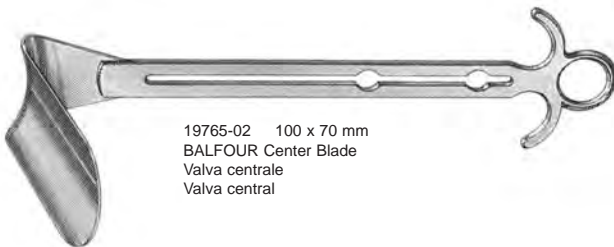

19765-02 100 x 70 mm
 BALFOUR Center Blade
 Valva centrale
 Valva central

Bauchdeckenhalter
 Abdominal Retractors
 Separadores abdominales
 Divaricatori addominali



19767-01
 Drahtvalven 6 cm (2.4") tief (Paar)
 Fenestrated blades 6 cm (2.4") deep (pair)
 Valvas de alambre 6 cm (2.4") profundidad (par)
 Valve di filo profondità 6 cm (2.4") (paio)



19767-02
 Drahtvalven 8 cm (3 1/8") tief (Paar)
 Fenestrated blades 8 cm (3 1/8") deep (pair)
 Valvas de alambre 8 cm (3 1/8") profundidad (par)
 Valve di filo profondità 8 cm (3 1/8") (paio)



BALFOUR-US
 19767-18
 komplett
 complete
 completo

Bauchdeckenhalter
Abdominal Retractors
Separadores abdominales
Divaricatori addominali

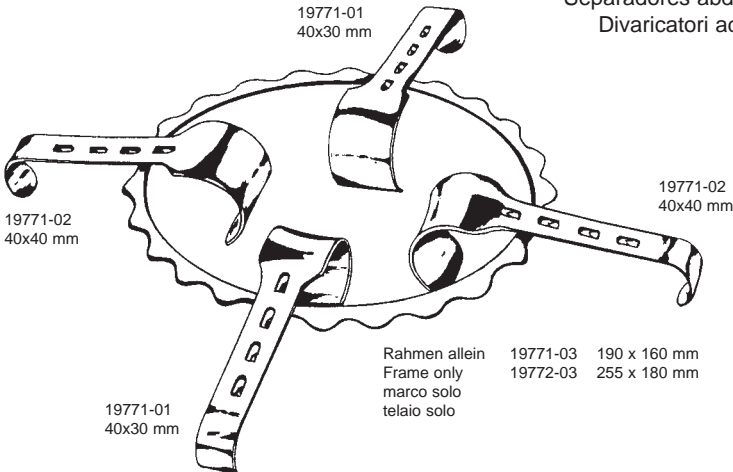

DENIS-BROWNE

19771-00 compl. Pediatric/pediatrico 190 x 160 mm
19772-00 compl. Adult/adulto 255 x 190 mm

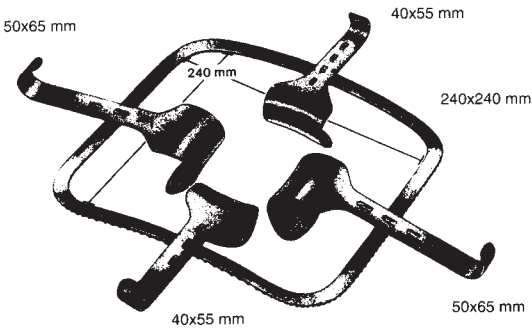

KIRSCHNER

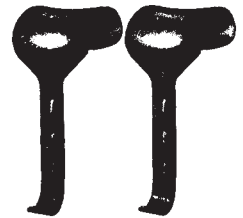

19781-55 (2 St./p.)
40 x 55 mm breit



19781-65 (2 St./p.)
50 x 65 mm breit

19782-00 Kirschner Bauchdeckenhalter komplett bestehend aus:
Kirschner Abdominal Retr. complete consisting of:
Kirschner separador abdominal, completo compuesto de:
Kirschner Divaricatore addominale completo, composto da:

19781-55 2 Rahmenhaken / 2 Hook-on Retr. / 2 separadores / 2 divaricatori 40 x 55 mm
19781-65 2 Rahmenhaken / 2 Hook-on Retr. / 2 separadores / 2 divaricatori 50 x 65 mm
19783-24 Rahmen fest / frame rigid / marco rigido / telaio rigido 240 x 240 mm

Bauchdeckenhalter
 Abdominal Retractors
 Separadores abdominales
 Divaricatori addominali

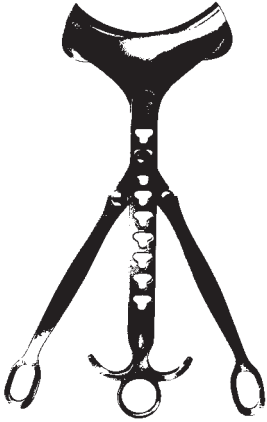

19780-01 + 19770-01

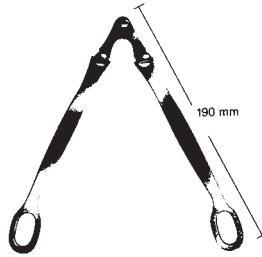

ROCHARD
 19780-01



ROCHARD
 31 cm, 12 1/4"
 19770-01 48x90 mm
 19770-02 48x105 mm
 19770-03 48x120 mm
 19770-04 48x135 mm
 19770-05 48x155 mm

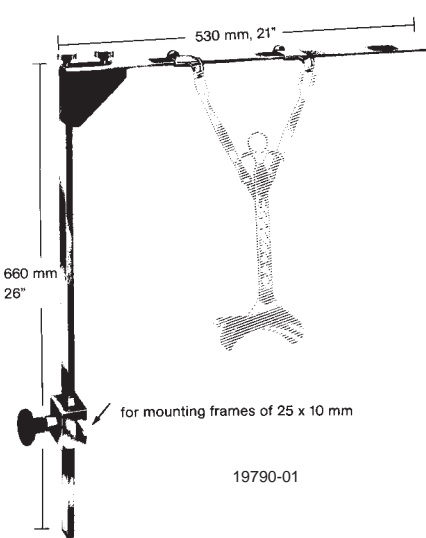

19790-01

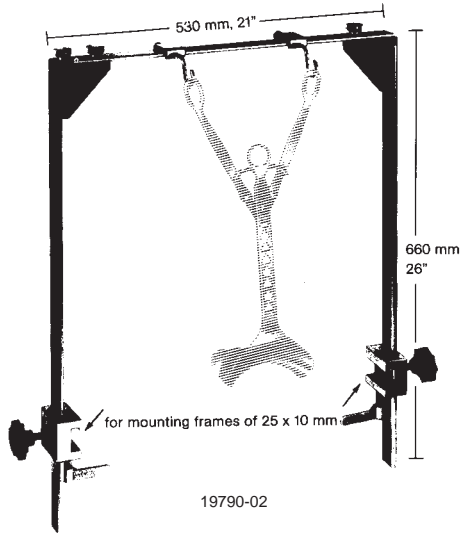

19790-02

Bauchdeckenhalter
Abdominal Retractors
Separadores abdominales
Divaricatori addominali

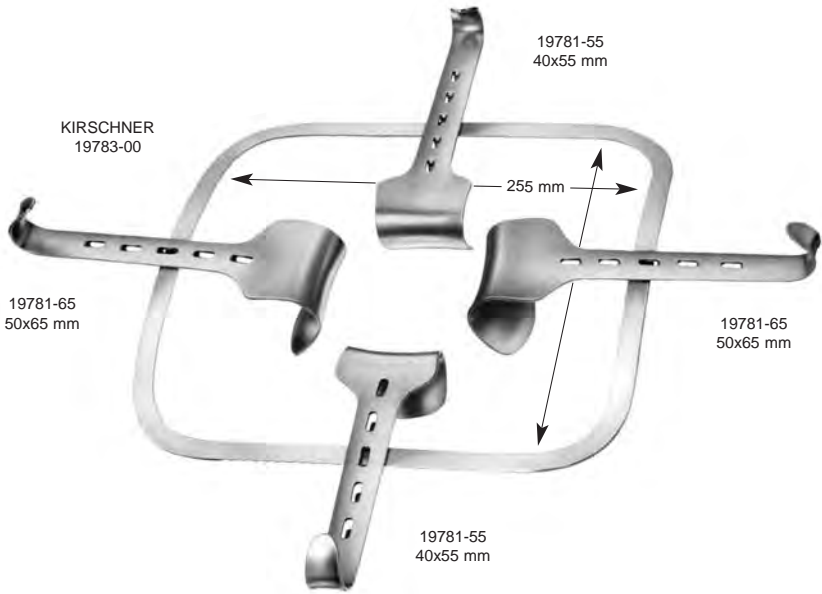

Bauchdeckenhalter
 Abdominal Retractors
 Separadores abdominales
 Divaricatori addominali

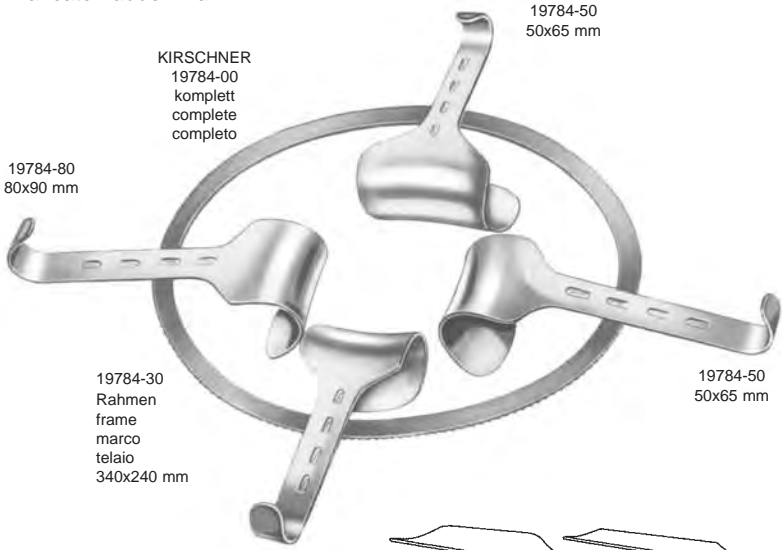

KIRSCHNER
 19784-00
 komplett
 complete
 completo

19784-50
 50x65 mm

19784-80
 80x90 mm

19784-30
 Rahmen
 frame
 marco
 telaio
 340x240 mm

19784-50
 50x65 mm

19784-80
 80x90 mm

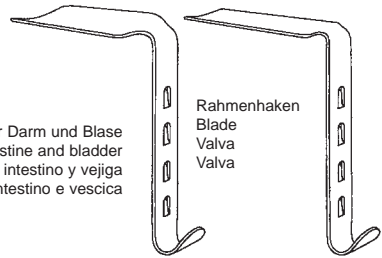

für Darm und Blase
 for intestine and bladder
 para intestino y vejiga
 per intestino e vescica

Rahmenhaken
 Blade
 Valva
 Valva

19784-98
 98x50 mm

19784-99
 105x35 mm

für adipöse Patienten
 for obese patients
 para pacientes obesos
 per pazienti obesi

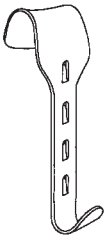

19784-40
 40x55 mm

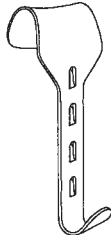

19784-50
 50x65 mm

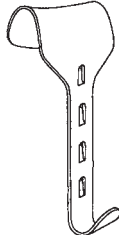

19784-60
 60x85 mm

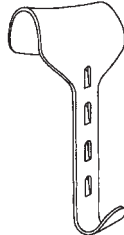

19784-78
 78x65 mm

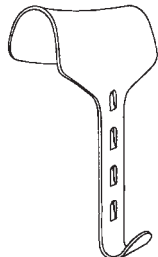

19784-80
 80x90 mm

Arm System
 Arm System
 Sistema de brazo
 Sistema braccio



19795-01
 Armsystem Radius 310/420 mm komplett mit Wundhakenhalter und U-Stativ Ø 16 mm, 400 mm hoch, 400 mm breit, 170 mm tief.
 Arm System, radius 310/420 mm, including retractor and U-stand Ø 16 mm, 400 mm high, 400 mm wide, 170 mm deep.



19795-02
 Armsystem Radius 310/420 mm komplett mit Stativ, Klemmsockel und Endoskophalter Ø 8/10 mm.
 Arm System, radius 310/420 mm, including stand, clamp, endoscope holder Ø 8/10 mm.



19798-01
 Einschlauchhalter
 Single tube holder



19798-02
 Endoskophalter Universal
 Ø 3-10 mm
 Endoscope holder Universal
 Ø 3-10 mm



19798-03
 Universelle
 Wundhakenhalterung
 Universal retractor holder

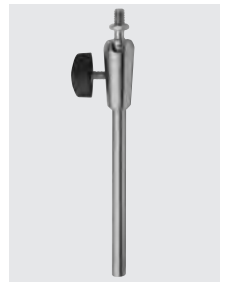

19798-04
 Gelenkverlängerung
 180 mm lang mit Feststellung
 Extended articulation
 180 mm long, lockable

Arm System
Arm System
Sistema de brazo
Sistema braccio



19799-01

Klemms socket aus rostfreiem Stahl, für ein höhenverstellbares Stativ Ø 16 mm, elektrisch isoliert bis 1,5 kV AC, Spannweite 35 mm für Schienen 25/32 x 8/12 mm.

Clamp socket made of stainless steel, for height-adjustable stand Ø 16 mm, electrically insulated up to 1.5 kV AC, holding width of 35 mm for rails 25/32 x 8/12 mm.



19799-02

Klemms socket aus rostfreiem Stahl, für ein höhenverstellbares Stativ Ø 16 mm, elektrisch isoliert bis 1,5 kV AC, Spannweite 35 mm für Schienen 25/32 x 8/12 mm.

Clamp socket made of stainless steel, for height-adjustable stand Ø 16 mm, electrically insulated up to 1.5 kV AC, holding width of 35 mm for rails 25/32 x 8/12 mm.



19799-03

Leichtmetall-Klemms socket Spannweite 35 mm, für ein Schraubstativ mit Ø 16 mm/M10, für Schienen 25/35 x 8/10 und Rohre Ø 12 - 35 mm. Clamp socket made of light metal, holding width 35 mm, for screw stand Ø 16 mm/M10, for rails 25/35 x 8/10 and tubes Ø 12 - 35 mm.



19799-04

Leichtmetall-Klemms socket Spannweite 50 mm, für ein höhenverstellbares Stativ Ø 16 mm, für Schienen 25/35 x 8/10 und Rohre Ø 12 - 35 mm. Clamp socket made of light metal, holding width 50 mm, for height-adjustable stand Ø 16 mm, for rails 25/35 x 8/10 and tubes Ø 12 - 35 mm.



19799-05

Klemms socket aus rostfreiem Stahl, für ein höhenverstellbares Stativ Ø 16 mm, elektrisch isoliert bis 4,5 kV AC, Spannweite 50 mm für Schienen 25/32 x 8/12 mm.

Clamp socket made of stainless steel, for height-adjustable stand Ø 16 mm, electrically insulated up to 4.5 kV AC, holding width of 50 mm for rails 25/32 x 8/12 mm.



19799-06

Leichtmetall-Klemms socket Spannweite 50 mm, für ein Schraubstativ mit Ø 16 mm/M10, für Schienen 25/35 x 8/10 und Rohre Ø 12 - 35 mm. Clamp socket made of light metal, holding width 50 mm, for screw stand Ø 16 mm/M10, for rails 25/35 x 8/10 and tubes Ø 12 - 35 mm.

Bauchdeckenhalter, Wundsperrer
 Abdominal Retractors, Retractors
 Separadores abdominales, Separadores
 Divaricatori addominali, Divaricatori

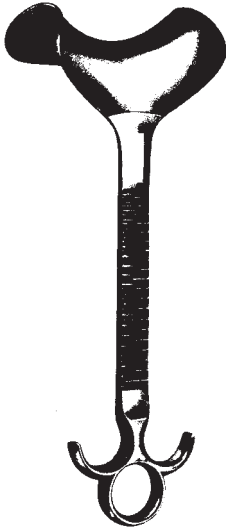

DOYEN
 28 cm, 11"
 19800-01 48x 90 mm
 19800-02 48x105 mm
 19800-03 48x120 mm
 19800-04 48x135 mm

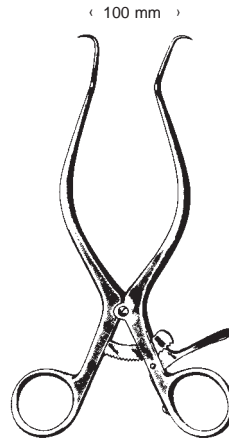

GELPI
 19802-09 9 cm, 3 1/2"
 19802-11 11 cm, 4 3/8"
 19802-14 14 cm, 5 1/2"
 19802-16 16 cm, 6 1/4"
 19802-18 18 cm, 7"



DE BAKEY
 19803-14
 14,5 cm, 5 3/4"

Wundsperrer
Retractors
Separadores
Divaricatori

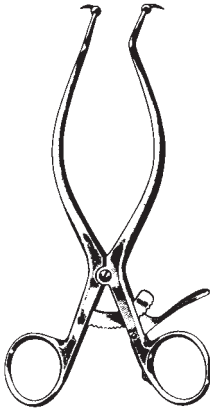

GELPI
19804-18
18 cm, 7"



JACKSON BURROWS
19805-18
18,5 cm, 7 1/4"

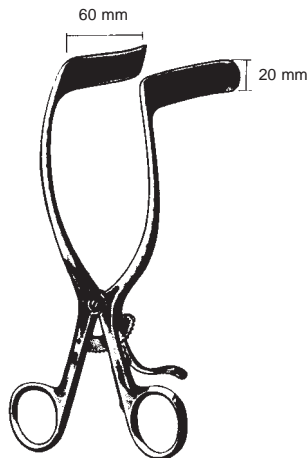

RIGBY
19806-18
18 cm, 7"

Bauchdeckenhalter
Abdominal Retractors
Separadores abdominales
Divaricatori addominali

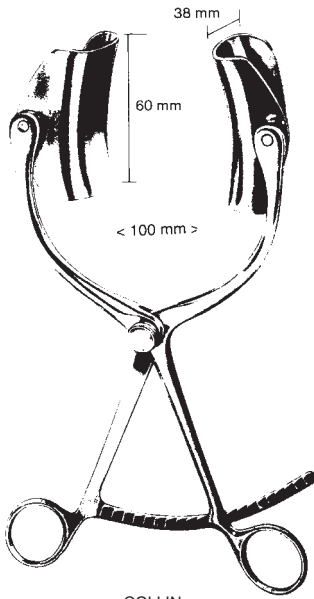

COLLIN
19810-22

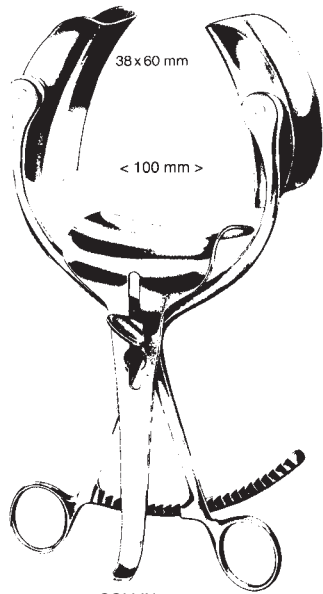

COLLIN
19812-60

Bauchdeckenhalter
Abdominal Retractors
Separadores abdominales
Divaricatori addominali

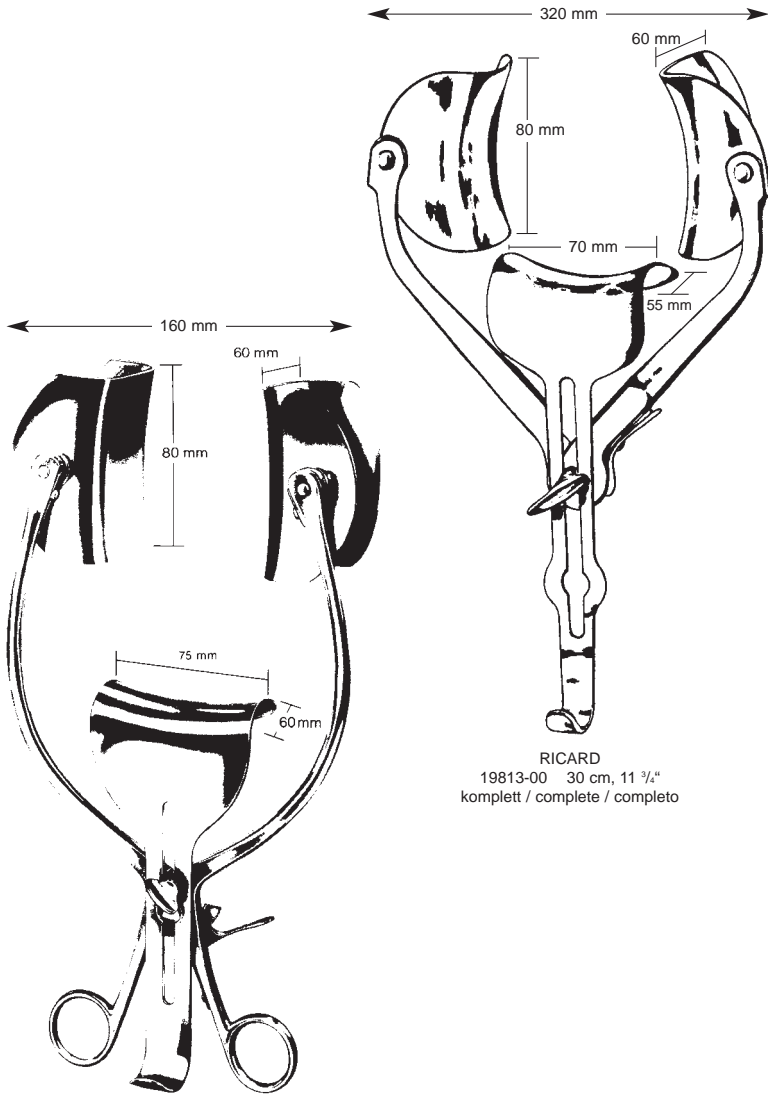

RICARD
19813-00 30 cm, 11 3/4"
komplett / complete / completo

COLLIN Loktite
19816-00 31 cm, 12 1/4"
komplett / complete / completo

Back holder Abdominal Retractor
Operation Table Set

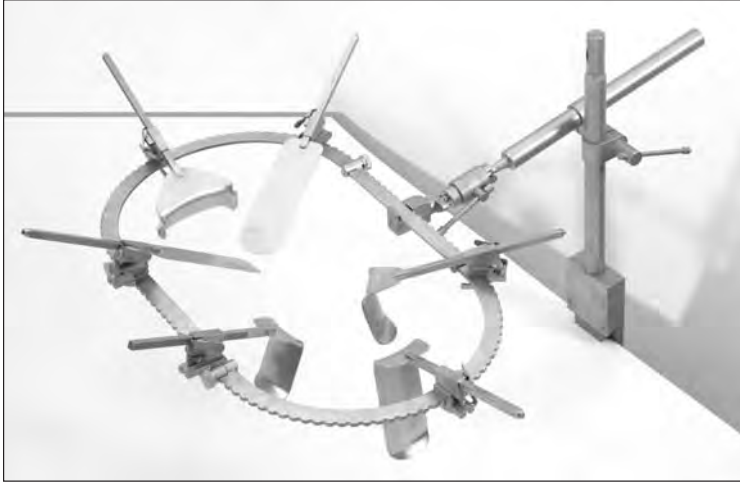

Complete Fixed Abdominal Retractor Set
Set completo divaricatore addominale con sistema di montaggio modulare

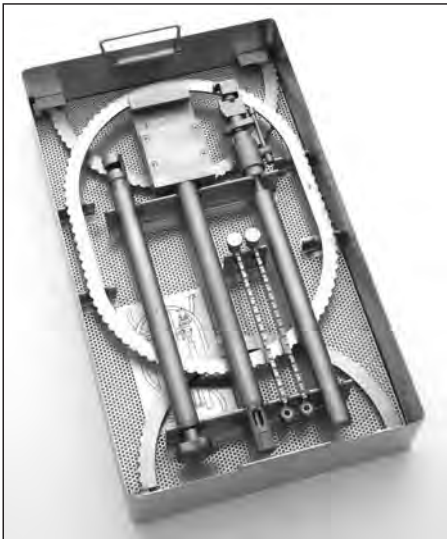

The many components of the **Back holder Abdominal Retractor Operation Table Set** can all be neatly arranged into autoclave sized containers with diagrams that direct instrument handlers on proper placement of each component.

A major convenience in care and maintenance of the Retractor Set

Sterilization Container & Baskets

Description	Product No
Table Fixation & Ring Case	19820-90
Blade & Accessories Case	19820-91

**Back holder Abdominal Retractor
Operation Table Set**

Description	Product No	<i>Composto da</i>	
Complete Abdominal Retractor Set	19820-99	Accoppiatore	19821-01
		Barra orizzontale	19821-02
<i>Includes</i>		Morsetto di accoppiamento	19821-04
Table Post	19821-01	Anello ovale	19820-02
Horizontal Bar	19821-02	No. 2 retrattori malleabili, 51x152 mm	19825-06
1" Post Coupling	19821-04	No. 2 Valve Kelly, dim. 51x76 mm	19822-23
Oval Ring	19820-02	Valva Kelly	19822-24
2" X 6" Malleable Retractor (2 ea)	19825-06	Valva Balfour	19823-33
2" X 3" Kelly Retractor (2 ea)	19822-23	Morsetto trasportabile con trasporto ad intervallo progressivo di 2 mm	19820-10
2" X 4" Kelly Retractor	19822-24	Morsetto articolato multidisciplinare con funzione movimento assiale orizzontale e verticale	19820-20
Balfour Retractor	19833-33	Anello rotondo circolare, dimensione 226 mm	19820-01
Ratchet Mechanism (2 ea)	19820-10	Anello ovale 266x367 mm	19820-02
Tilt Ratchet Mechanism (6 ea)	19820-20	Anello a segmento 266x495 mm	19820-03
Segmented Ring	19820-03	Retrattore malleabile 38x152 mm	19824-06
1 1/2" X 6" Malleable Retractor	19824-06	Retrattore malleabile 76x152 mm	19826-06
3" x 6" Malleable Retractor	19826-06	Valva Kelly, 51x127 mm	19822-25
2" X 5" Kelly Retractor	19822-25	Valva Kelly, 51x152 mm	19822-26
2" X 6" Kelly Retractor	19822-26	Valva Kelly, 51x152 mm	19822-26
Horizontal Flex Bar	19821-03	Barra flessibile orizzontale	19821-03
Harrington Retractor	19831-25	Retrattore Harrington 63x143 mm	19831-25
Gelpi Retractor	19834-01	Retrattore con punta Gelpi	19834-01
<i>Accessories</i>		<i>Accessori:</i>	
Table Fixation & Ring Case	19820-90	Container in acciaio inox dotato con griglia interna	
Blades & Accessories Case	19820-91	Descrizione	
		Container in acciaio inox dotato di griglia interna per Accessori di fissazione, anelli e barre	19820-90
		Container in acciaio inox dotato di griglia interna per morsetti e divaricatori	19820-91

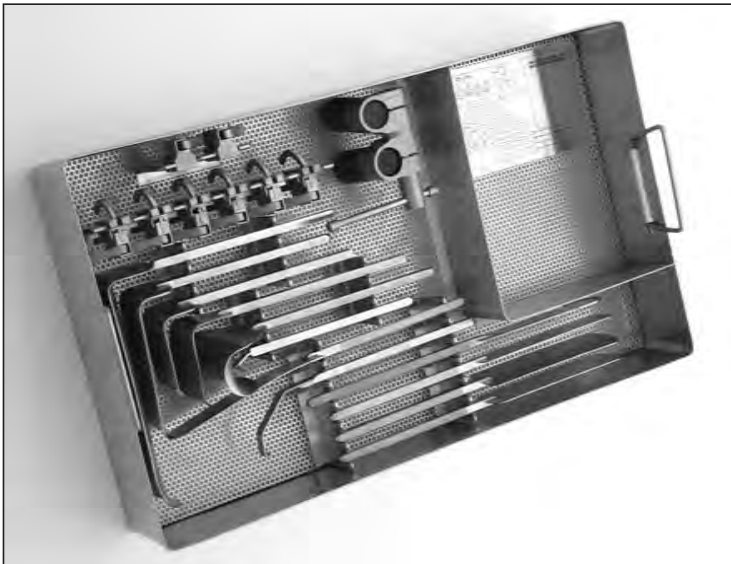

Malleable Retractors with Protective Edge

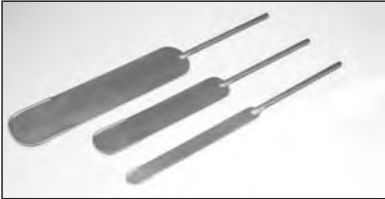

Description	Product No
1 1/2" x 6" 38 x 152 mm	19824-06
2" x 6" 51 x 152 mm	19825-06
3" x 6" 76 x 152 mm	19826-06

Harrington Retractors

Description	Product No
Blade 2.5" x 5 5/8" 63 x 143 mm	19831-25



Specialty Retractors

Description	Product No
Balfour Retractor 2 5/8" x 3" 67 x 76 mm	19833-33
Gelpi Point Retractor	19834-01

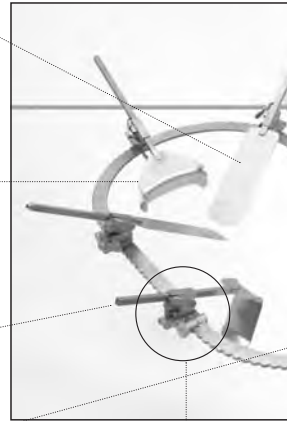

Description	Product No
Blade 2" x 1 1/2"	51 x 38 mm 19822-21
Blade 2" x 2"	51 x 51 mm 19822-22
Blade 2" x 2 1/2"	51 x 64 mm 19822-22L
Blade 2" x 3"	51 x 76 mm 19822-23
Blade 2" x 4"	51 x 102 mm 19822-24
Blade 2" x 5"	51 x 127 mm 19822-25
Blade 2" x 6"	51 x 152 mm 19822-26



Description	Product No
Blade 1" x 1 1/2"	25 x 38 mm 19822-01
Blade 1" x 2 1/2"	25 x 63 mm 19822-02



Tilt Ratchet Mechanism allows extensions or retractions along the horizontal axis and allows vertical movement of retractor blade with a second ratchet

Product No 19820-20

Table Mounting Components

Description **Product No**
 1" Post Coupler 19821-04

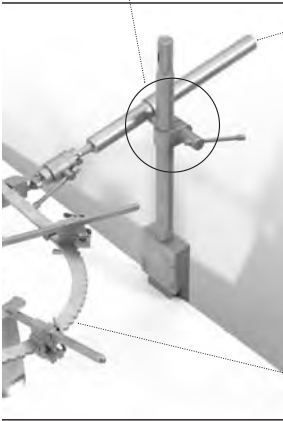

Fixed Ratchet Mechanism allows extension or retraction along the horizontal axis at 2mm intervals

Product No 19820-10

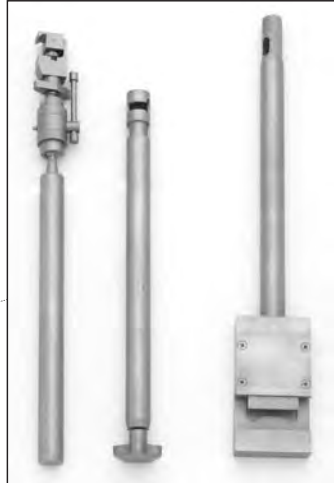

Table Mounting Components

Table Post 19821-01
 Horizontal Bar 19821-02
 Horizontal Flex Bar 19821-03



Retractor Rings

Description	Product No
Round Ring 10.5 inch / 266 mm	19820-01
Oval Ring 10.5 x 14.5 inch / 266 x 367 mm	19820-02
Segmented Ring 10.5 x 19.5 inch / 266 x 495 mm	19820-03
(Consists of one 10.5 inch Round Ring and two 8 inch straight segments)	

Laminectomiespreizer
 Laminectomy Retractors
 Separadores para laminectomia
 Divaricatori per laminectomia



19910-00
 SCOVILLE-HAVERFIELD
 Rahmen allein
 Frame only
 Marco solo
 Telaio solo



19911-00
 SCOVILLE
 Rahmen allein
 Frame only
 Marco solo
 Telaio solo



SCOVILLE
 50 mm, 2"
 19912-50



SCOVILLE
 70 mm, 2 3/4"
 19912-70



SCOVILLE
 19914-41 41 x 38 mm
 19914-67 67 x 44 mm



TAYLOR
 19915-48 48 x 50 mm
 19915-64 64 x 50 mm
 19916-64 64 x 64 mm
 19916-80 80 x 57 mm



SCOVILLE
 50 mm, 2"
 19913-50



SCOVILLE
 70 mm, 2 3/4"
 19913-70



SCOVILLE
 19917-64 64 x 25 mm
 19918-64 64 x 50 mm
 19918-88 88 x 25 mm

Wundhaken für plastische Chirurgie
 Retractors for plastic surgery
 Separadores para cirugía plástica
 Divaricatore per chirurgia plastica



mit Kaltlicht + Absaugung
 with cold light + aspiration
 con luz fria + aspiracion
 con luce fredda + aspirazione

TEBBETTS

19980-01	80 mm x 16 mm
19980-02	100 mm x 25 mm
19980-03	120 mm x 25 mm
19980-04	120 mm x 30 mm
19980-05	150 mm x 25 mm
19980-06	150 mm x 30 mm



FERRIERA

19960-01	80 mm x 16 mm
19960-02	100 mm x 25 mm
19960-03	120 mm x 25 mm
19960-04	120 mm x 30 mm
19960-05	150 mm x 25 mm
19960-06	150 mm x 30 mm

Wundhaken für plastische Chirurgie
 Retractors for plastic surgery
 Separadores para cirugía plástica
 Divaricatore per chirurgia plastica



19970-01
 37 x 70 mm
 22 x 54 mm

BREAST
 31 cm, 12 1/4"



CORONAL BLOW LIFT
 19980-18
 18 cm, 7"



YANCOSKIE
 19990-18
 18 cm, 7"



FREEMAN
 19995-38 18 cm, 7"
 38 mm, 1 1/2" wide

19995-22 18 cm, 7"
 22 mm, 7/8" wide



ANDERSON
 19998-03 12 cm, 4 3/4" 3 prong
 3 rebbi

19998-05 12 cm, 4 3/4" 5 prong
 5 rebbi

Sonden
Probes, Directors
Sondas, estiletes
Sonde, specilli



2 mm ø

11,5 cm, 4 1/2" 21102-11
13,0 cm, 5 1/8" 21102-13
14,5 cm, 5 3/4" 21102-14
16,0 cm, 6 1/4" 21102-16
18,0 cm, 7" 21102-18
20,0 cm, 8" 21102-20
25,0 cm, 10" 21102-25



1 mm ø

21104-11
21104-13
21104-14
21104-16
21104-18
21104-20
21104-25



2 mm ø

21106-11
21106-13
21106-14
21106-16
21106-18
21106-20
21106-25

21108-14
14,5 cm, 5 3/4"BRODIE
21109-18
18 cm
7"

13,0 cm, 5 1/8" 21110-13
14,5 cm, 5 3/4" 21110-14
16,0 cm, 6 1/4" 21110-16
18,0 cm, 7" 21110-18
20,0 cm, 8" 21110-20

DOYEN
21111-14
14 cm
5 1/2"21112-14
14,5 cm
5 3/4"STACKE
21115-10
10,5 cm
4.1"NELATON
21120-16
16 cm
6 1/4"FISH
21121-14
14 cm, 5 1/2"
21121-18
18 cm, 7"WATSON-CHEYNE
21122-13
13 cm, 5 1/8"
21122-18
18 cm, 7"

Fistelsonden
Fistula Probes
Sondas para fistula
Sonde per fistole



LOCKHART-MUMMERY
21125-01
16,5 cm, 6 1/2"



LOCKHART-MUMMERY
21125-02
16,5 cm, 6 1/2"



LOCKHART-MUMMERY
21125-03
16,5 cm, 6 1/2"



LOCKHART-MUMMERY
21125-04
16,5 cm, 6 1/2"

Krampfader-Besteck in Metalletui
 Varicose vein probe set in metal case
 Juego para várices en estuche de metal
 Astuccio per varici in scatola di metallo

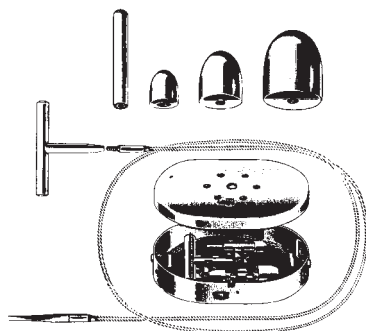

NABATOFF
 21150-00
 135x100x25 mm
 compl.

Ersatzteile
 Spare parts
 Piezas de repuesto
 Pezzi di ricambio

21150-02



21150-90

Zugseil
 cable flexible
 cable de traccion flex.
 Corda di trazione fless.

21150-80



Handgriff
 Handle only
 Mango suelto
 Manico solo



21150-03
 3 mm \varnothing



21150-06
 6 mm \varnothing



21150-09
 9 mm \varnothing



21150-12
 12 mm \varnothing



21150-15
 15 mm \varnothing

Sondenspitzen
 Probe Tip
 Puntas sueltas
 Punte

Varizeninstrumente
 Varix Instruments
 Instrumentos para varices
 Strumenti per varici



VARADY
 21154-01
 180 mm, 7"



VARADY
 21154-02
 180 mm, 7"



VARADY
 21154-03
 180 mm, 7"



VARADY
 21154-04
 175 mm, 6.9"



VARADY
 21154-05
 170 mm, 6 3/4"



VARADY
 21154-06
 170 mm, 6 3/4"

21162-12
 12 cm, 4 3/4"
 Griff
 Handle
 Mango
 Manico

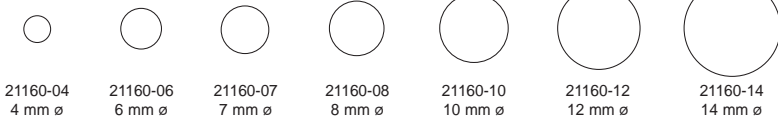
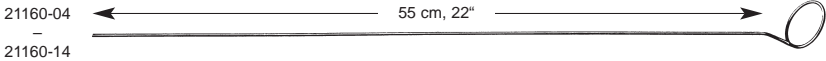

Watteträger, Spatel
 Cotton Applicators, Spatulas
 Porta-algodones, Espátulas
 Portacotone, Spatole



FARRELL

4 3/4"	21270-12	12,0 cm
5 1/2"	21270-14	14,0 cm
6 1/2"	21270-16	16,5 cm
7"	21270-18	18,0 cm
9"	21270-23	23,0 cm



FARRELL

21272-12	12,0 cm
21272-14	14,0 cm
21272-16	16,5 cm
21272-18	18,0 cm
21272-23	23,0 cm



1,5

REDA

4 3/4"	21290-12	12,0 cm
5 1/2"	21290-14	14,0 cm
6 1/2"	21290-16	16,0 cm
7"	21290-18	18,0 cm



1,5

REDA

21292-12	12,0 cm
21292-14	14,0 cm
21292-16	16,0 cm
21292-18	18,0 cm

Spatel
 Plaster spatula
 Espátula
 Spatole



21190-14
 14,5 cm, 5 3/4"



UCKERMANN
 21310-15
 15 cm, 6"

ø 3 mm



JOBSON-HORNE
 21320-12 12 cm, 4 3/4"
 21320-18 18 cm, 7"



TOBOLD
 21331-25
 25 cm, 10"

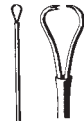

21340-45
 45 cm, 17 3/4"

Trokare
Trocars
Trócares
Trequarti

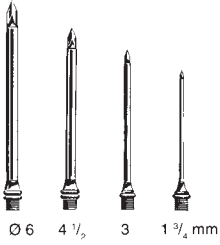

Ø 6 4 1/2 3 1 3/4 mm



UNIVERSAL
23104-00
compl.



STANDARD (Nelson)
23110-30 3,0 mm Ø
23110-35 3,5 mm Ø
23110-40 4,0 mm Ø
23110-45 4,5 mm Ø
23110-50 5,0 mm Ø
23110-55 5,5 mm Ø
23110-60 6,0 mm Ø



PIERCE
23123-30 3,0 mm Ø
23123-40 4,0 mm Ø
23123-50 5,0 mm Ø



DOUGLAS
23125-11 3 mm Ø



LICHTWITZ
23128-19 1,75 mm Ø

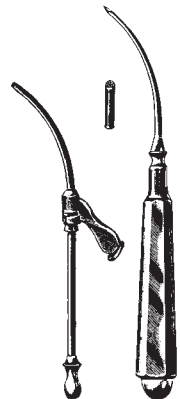

COAKLEY
23140-02 2,25 mm Ø

Trokare
Trocars
Trócares
Trequarti



Charr./	F.G.	OCHSNER
10	23150-10	
12	23150-12	
14	23150-14	
16	23150-16	
18	23150-18	
20	23150-20	



Charr./	F.G.	NELSON	ø
25	23170-25		7,5 mm
30	23170-30		9,0 mm
33	23170-33		10,5 mm
35	23170-35		12,0 mm



SINOSKOPIE-TROKAR
universal
8,5 cm, 3.4"

23180-27 f. Optik mit Ø 2,7 mm
23180-40 f. Optik mit Ø 4,0 mm



SINOSKOPIE-TROKAR
abgeschragt/oblique beak
8,5 cm, 3.4"

23181-40 f. Optik mit Ø 4,0 mm

Biopsiekanülen
 Biopsy Needles
 Aguja para biopsia
 Aghi per biopsia

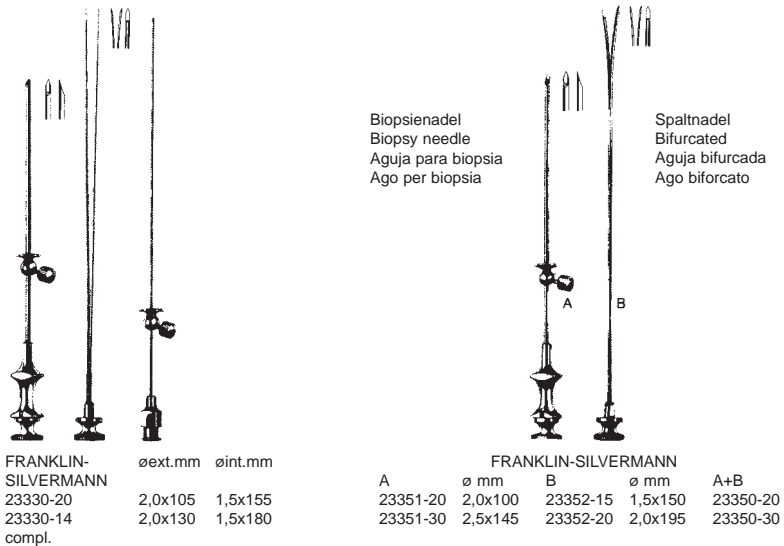
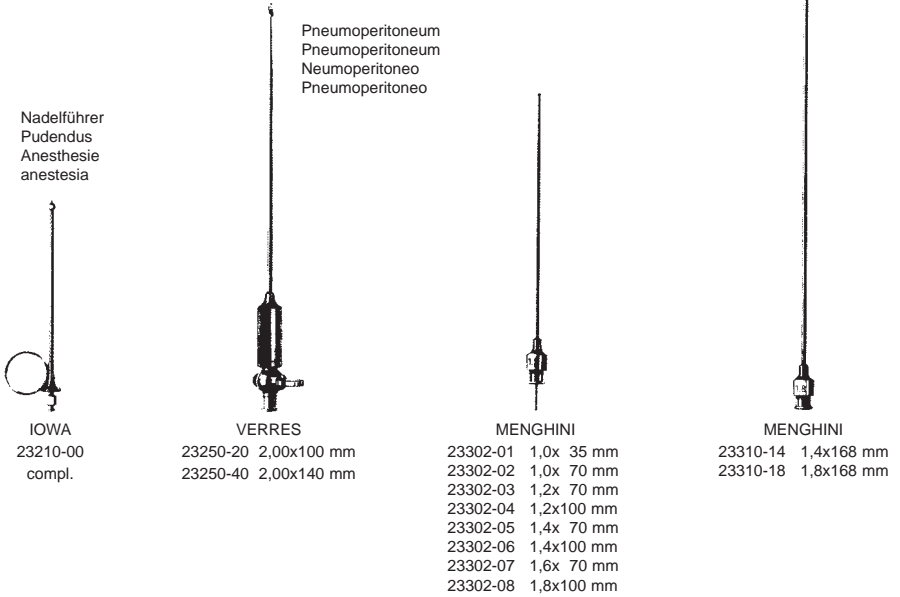

Führungsnadeln
 Guide needles
 Aguja de Guía
 Ago guida

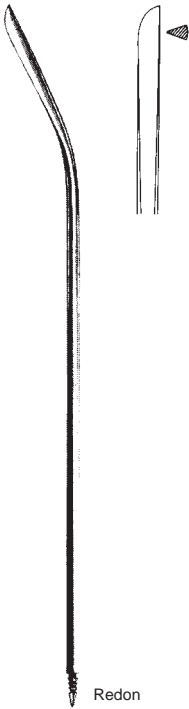

Redon

23195-08 - 23195-18

Führungsnadel, gerade
 Guide Needle, straight
 Aguja de guía, recta
 Ago guida, retta

Charr./Fr.

8 23195-08
 10 23195-10
 12 23195-12
 14 23195-14
 16 23195-16
 18 23195-18

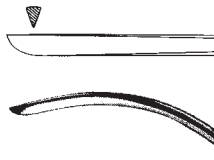

Redon

23197-08 - 23197-18

Führungsnadel, gebogen
 Guide Needle, curved
 Aguja de guía, curva
 Ago guida, curva

Charr./Fr.

8 23197-08
 10 23197-10
 12 23197-12
 14 23197-14
 16 23197-16
 18 23197-18

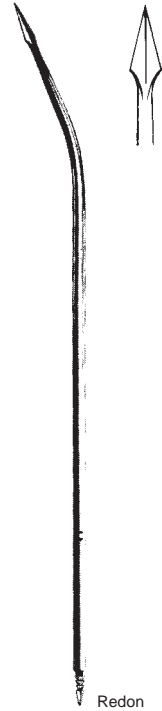

Redon

23198-08 - 23198-18

Führungsnadel, Lanzettspitze
 Guide Needle, with lancet tip
 Aguja de guía, con punta lanceolar
 Ago guida, con punta lanceolata

Charr./Fr.

8 23198-08
 10 23198-10
 12 23198-12
 14 23198-14
 16 23198-16
 18 23198-18

Nadelhalter
Needle Holders
Porta-agujas
Port'aghi

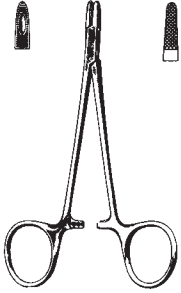

DERF
25110-12
12 cm, 4 3/4"
25114-12 TC
12 cm, 4 3/4"



DERF
25120-12
12,5 cm, 5"



COLLIER
25122-12
12,5 cm, 5"

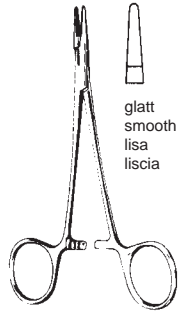

glatt
smooth
lisa
liscia

WEBSTER
25128-13
13 cm, 5 1/8"
25129-13 TC
13 cm, 5 1/8"

BABY-WEBSTER
25136-11
11 cm, 4 3/8"
25137-11 TC
11 cm, 4 3/8"

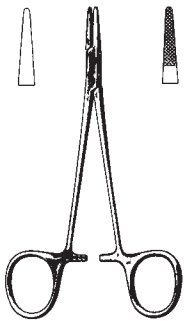

HALSEY
25130-13 25140-13
25134-13 TC 25144-13 TC
13 cm, 5 1/8"

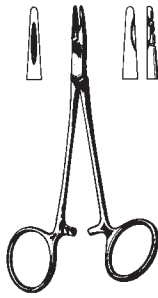

NEIVERT
25146-13
13 cm, 5 1/8"

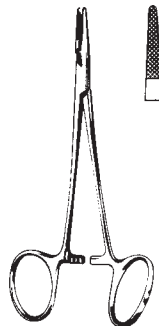

NEIVERT
25148-13 TC
13 cm, 5 1/8"

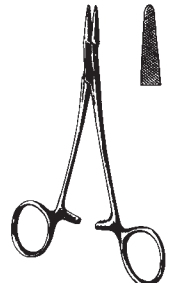

BAUMGARTNER
25150-12 **25154-12 TC**
12,5 cm, 5"
25150-14 **25154-14 TC**
14,0 cm, 5 1/2"

Nadelhalter
Needle Holders
Porta-agujas
Port'aghi



CRILE-WOOD

25160-15	15 cm, 6"	25164-15 TC
25160-18	18 cm, 7"	25164-18 TC
25160-20	20 cm, 8"	25164-20 TC
25160-23	23 cm, 9"	25164-23 TC



CRILE-MURRAY

25170-15	25174-15 TC
15 cm, 6"	

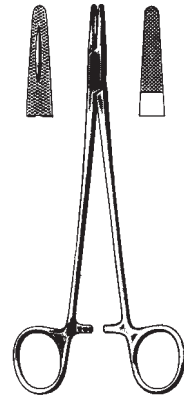

MAYO-HEGAR

25180-12	12 cm, 4 3/4"	25184-12 TC
25180-14	14 cm, 5 1/2"	25184-14 TC
25180-16	16 cm, 6 1/4"	25184-16 TC
25180-18	18 cm, 7"	25184-18 TC
25180-20	20 cm, 8"	25184-20 TC
25180-24	24 cm, 9 1/2"	25184-24 TC
25180-26	26 cm, 10 1/4"	25184-26 TC
25180-30	30 cm, 11 3/4"	25184-30 TC

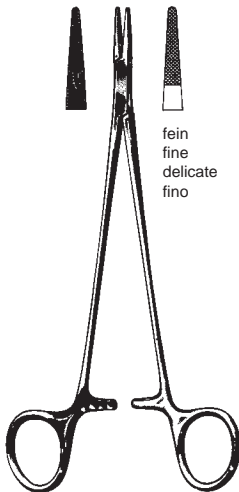

fein
fine
delicate
fino

MAYO-HEGAR

25190-16	16 cm, 6 1/4"	25194-16 TC
25190-18	18 cm, 7"	25194-18 TC
25190-20	20 cm, 8"	25194-20 TC

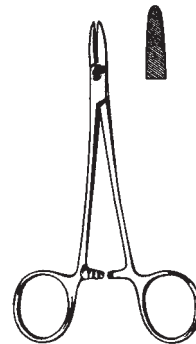

BROWN

25196-13	13 cm, 5 1/8"
25196-18	18 cm, 7"

Nadelhalter
Needle Holders
Porta-agujas
Port'aghi



DE BAKAY

25214-16 TC	16 cm, 6 1/4"
25214-18 TC	18 cm, 7"
25214-20 TC	20 cm, 8"
25214-23 TC	23 cm, 9"
25214-26 TC	26 cm, 10 1/4"
25214-31 TC	31 cm, 12 1/4"



RYDER 1 mm

25224-13 TC	13 cm, 5 1/8"
25224-15 TC	15 cm, 6"
25224-18 TC	18 cm, 7"
25224-20 TC	20 cm, 8"
25224-23 TC	23 cm, 9"
25224-26 TC	26 cm, 10 1/4"

RYDER 2 mm

25225-13 TC	
25225-15 TC	
25225-18 TC	
25225-20 TC	
25225-23 TC	
25225-26 TC	



schlankes Modell
slender pattern
modelo delgado
modello gracile

MICROVASCULAR

25230-18 TC	18 cm, 7"
25230-20 TC	20 cm, 8"
25230-23 TC	23 cm, 9"

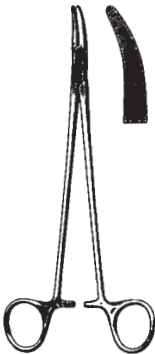

HEANEY

25241-21	21 cm, 8 1/4"
25241-26	26 cm, 10 1/4"
25245-21 TC	21 cm, 8 1/4"
25245-26 TC	26 cm, 10 1/4"

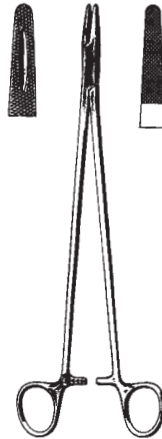

MASSON

25250-27	27 cm, 10 1/2"
25254-27 TC	27 cm, 10 1/2"



WANGENSTEEN

25260-27	27 cm, 10 1/2"
25264-27 TC	27 cm, 10 1/2"

Nadelhalter
Needle Holders
Porta-agujas
Port'aghi

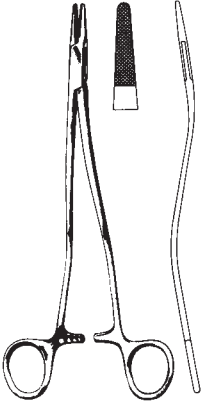

BOZEMANN

25285-20 TC 20 cm, 8"
25285-24 TC 24 cm, 9 1/2"
25285-26 TC 26 cm, 10 1/4"

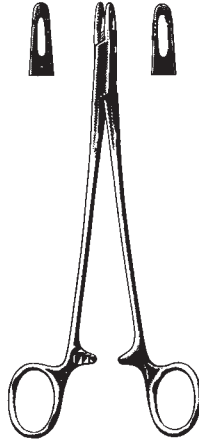

METZENBAUM

25290-18
18 cm, 7"



ADSON

25292-18
18 cm, 7"

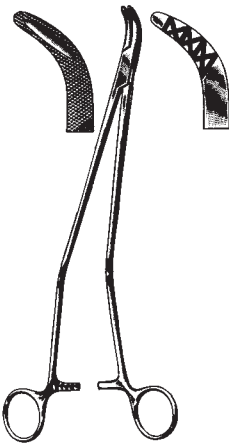

JOHNSON

25293-27
27 cm, 10 1/2"



FINOCHIETTO

25311-20 20 cm, 8" 25315-20 TC
25311-27 27 cm, 10 1/2" 25315-27 TC

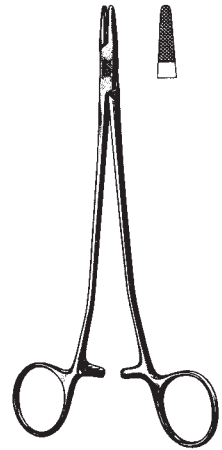

SAROT

25324-18 TC 18 cm, 7"
25324-26 TC 26 cm, 10 1/4"

Nadelhalter
Needle Holders
Porta-agujas
Port'aghi

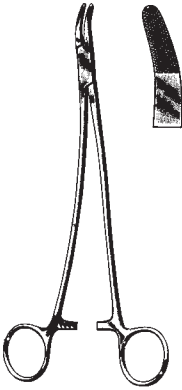

STRATTE
25330-21 21 cm, 8 1/4"
25330-23 23 cm, 9" **25334-23 TC**

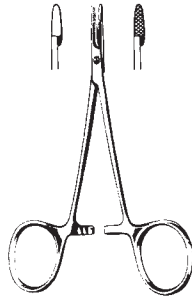

BABY-OLSEN-HEGAR
25405-12 25406-12
25408-12 TC 25407-12 TC
11,5 cm, 4 1/2"

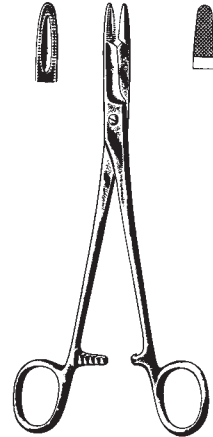

OLSEN-HEGAR
25410-14 14 cm, 5 1/2" **25414-14 TC**
25410-17 17 cm, 6 3/4" **25414-17 TC**
18 cm, 7" **25414-18 TC**



MATHIEU-OLSEN
25415-14 TC 14 cm, 5 1/2"
25415-17 TC 17 cm, 6 3/4"
25415-20 TC 20 cm, 8"

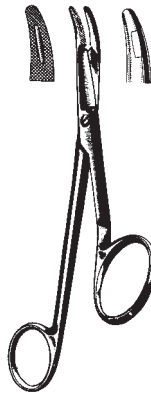

GILLIES
25430-16 16 cm, 6 1/4" **25434-11 TC**
13 cm, 5 1/8" **25434-13 TC**
25434-16 TC

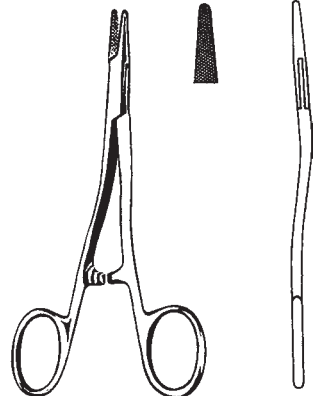

KILNER
25436-13 13 cm, 5 1/8" **25438-13 TC**
13 cm, 5 1/8"

Nadelhalter
Needle Holders
Porta-agujas
Port'aghi



HOESEL
25446-25 25 cm, 10"
25447-25 TC 25 cm, 10"



CRILE
25438-15 15 cm, 6"

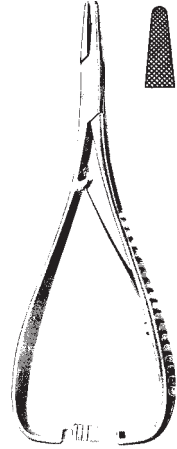

MATHIEU
25450-14 14 cm, 5 1/2" 25452-14 TC
25450-17 17 cm, 6 1/4" 25452-17 TC
25450-20 20 cm, 8" 25452-20 TC
25450-24 24 cm, 9 1/2" 25452-24 TC

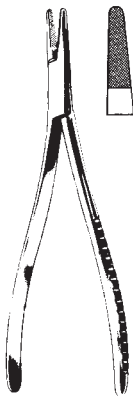

LANGENBECK
25460-18 TC 18 cm, 7"
25460-20 TC 20 cm, 8"
25460-23 TC 23 cm, 9"

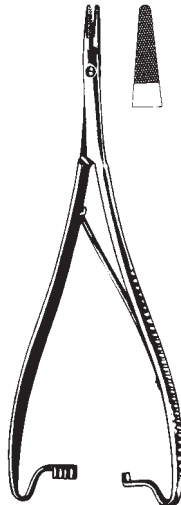

HOESEL
25465-20 TC 20 cm, 8"
25465-25 TC 25 cm, 10"



LICHTENBERG
25466-17 17 cm, 6 3/4" 25467-17 TC
25466-20 20 cm, 8" 25467-20 TC

Nadelhalter
Needle Holders
Porta-agujas
Port'aghi

Oftalmologie
Ophthalmology
Oftalmologia
Oftalmologia



STEVENS
25610-11
11 cm, 4 3/8"



STEVENS
25612-13 13 cm, 5 1/8"
25612-15 15 cm, 6"

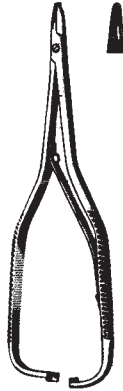

BOYNTON
25614-12
12 cm, 4 3/4"



BOYNTON
25615-12 TC
12 cm, 4 3/4"



ARRUGA
25620-16 - 25624-16
16 cm, 6 1/4"



25620-16



25621-16



25624-16 TC



25625-16 TC

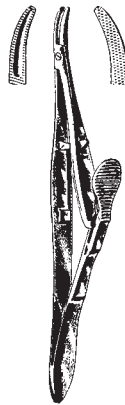

KALT-ARRUGA
25627-14
14 cm, 5 1/2"



KALT
25628-14
14 cm, 5 1/2"

Nadelhalter
Needle Holders
Porta-agujas
Port'aghi



JACOBSEN

- 25667-18 18 cm, 7"
- 25668-18 TC 18 cm, 7"
- 25667-21 21 cm, 8 1/4"
- 25668-21 TC 21 cm, 8 1/4"



CASTROVIEJO

14 cm, 5 1/2"



25670-14
glatt
smooth
lisa
liscia



25672-14
gerieft
serrated
estriada
zigrinato



25676-14 TC



25671-14
glatt
smooth
lisa
liscia



25673-14
gerieft
serrated
estriada
zigrinato



25677-14 TC



25678-09



CASTROVIEJO-MICRO

9 cm, 3 1/2"



25679-09



CASTROVIEJO

- 25680-13 13 cm, 5 1/8"
- 25684-13 TC 13 cm, 5 1/8"

Mikro-Nadelhalter
Micro-Needle Holders
Micro-Porta-agujas
Micro-Port'aghi



CASTROVIEJO-STANDARD
25678-14 14 cm, 5 1/2"



CASTROVIEJO-STANDARD
25679-14 14 cm, 5 1/2"

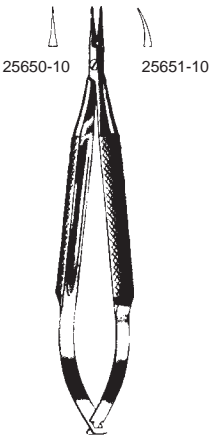

BARRAQUER
10 cm, 4"



BARRAQUER-TROUTMAN
10 cm, 4"

Mikro-Nadelhalter
 Micro-Needle Holders
 Micro-Porta-agujas
 Micro-Port'aghi



BARRAQUER
 13 cm, 5 1/8"

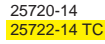

BARRAQUER
 14 cm, 5 1/2"

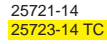

BARRAQUER
 18 cm, 7"

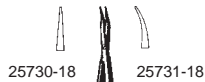

BARRAQUER
 18 cm, 7"



Unterbindungsnadeln
 Ligature Needles
 Aguja para ligaduras
 Aghi per legature



biegsam
 malleable
 maleable
 malleabile

27109-20

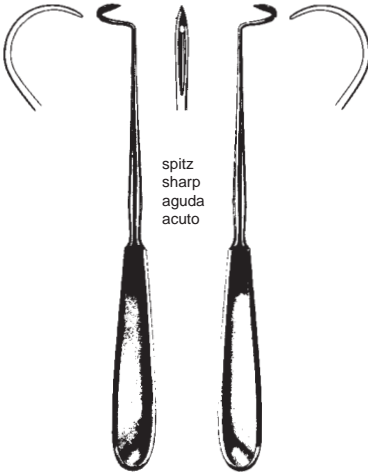

spitz
 sharp
 aguda
 acuto

stumpf
 blunt
 roma
 smusso

L	DESCHAMPS	R
27110-21	21 cm, 8 1/4"	27111-21
27110-24	24 cm, 9 1/2"	27111-24
27110-27	27 cm, 10 1/2"	27111-27

L	DESCHAMPS	R
27120-21	21 cm, 8 1/4"	27121-21
27120-24	24 cm, 9 1/2"	27121-24
27120-27	27 cm, 10 1/2"	27121-27

Unterbindungsnadeln
Ligature Needles
Agujas para ligaduras
Aghi per legature

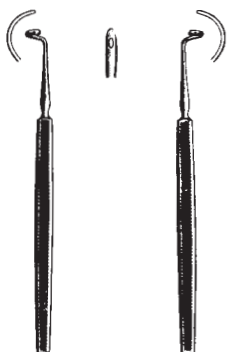

L KRONECKER R
27130-13 27131-13
13 cm, 5 1/4"

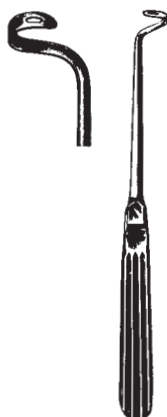

L NELSON R
27133-24 27135-24
24,5 cm, 9 3/4"



SCHMIEDEN-DICK
27134-32 32 cm, 12 3/4"



COOPER
27139-19 19 cm, 7 1/2"

Nahtinstrumente
 Suturing Instruments
 Instrumentos para suturas
 Strumenti per suture

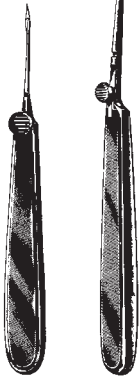

REVERDIN
 27201-15 - 27204-21



Fig. 1
 27201-15 15 cm, 6"
 27201-19 19 cm, 7 1/2"
 27201-21 21 cm, 8 1/4"



Fig. 2
 27202-15 15 cm, 6"
 27202-19 19 cm, 7 1/2"
 27202-21 21 cm, 8 1/4"



Fig. 3
 27203-15 15 cm, 6"
 27203-19 19 cm, 7 1/2"
 27203-21 21 cm, 8 1/4"



Fig. 4
 27204-15 15 cm, 6"
 27204-19 19 cm, 7 1/2"
 27204-21 21 cm, 8 1/4"



YOUNG BOOMERANG
 27240-00
 25 cm, 10"



Fig. 1
 27240-01

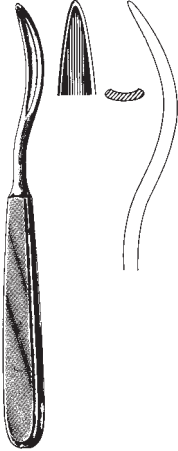

Fig. 2
 27240-02



Fig. 3
 27240-03

Führungshohlsonden
Ligature Conductors
Sondas conductoras
Sonde conduttrici



SCHMIEDEN
27271-19
19 cm, 7 1/2"



SCHMIEDEN-PAYR
27273-19
19 cm, 7 1/2"

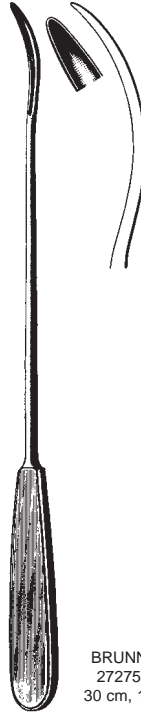

BRUNNER
27275-30
30 cm, 11 1/2"

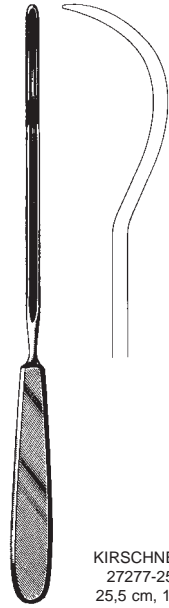

KIRSCHNER
27277-25
25,5 cm, 10"

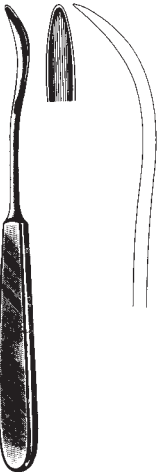

KOENIG
27285-20
20 cm, 8"



PAYR
27288-22
22 cm, 8 3/4"



PAYR
27289-22
22 cm, 8 3/4"



Plastik
plastic
plástico

BRUNNER
27291-18 18 cm, 7"
27291-27 27 cm, 10 1/2"



VIENNA
27297-23
23,5 cm, 9 1/4"



REDA
27298-23
23 cm, 9"

Chirurgische Nadeln
Suturing Needles
Agujas para suturas
Aghi per suture

Pack à 1 Dutzend
in packages of 1 dozen
en sobres de 1 docena
confezione 1 dozzina

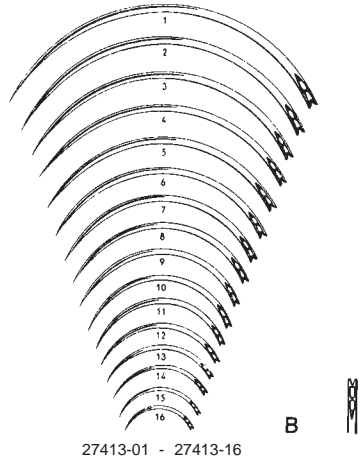
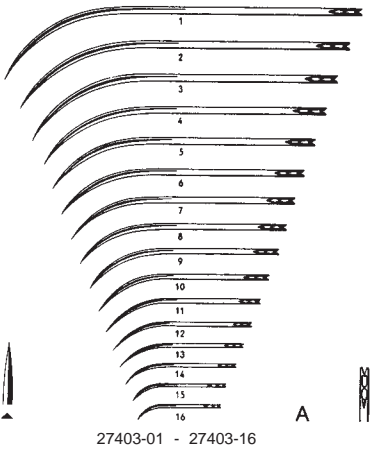
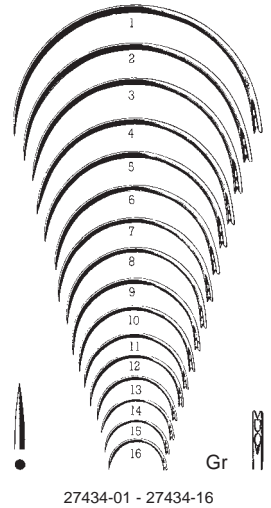
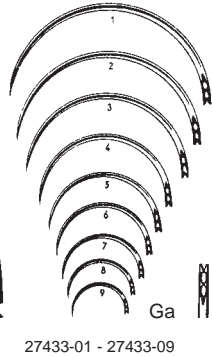
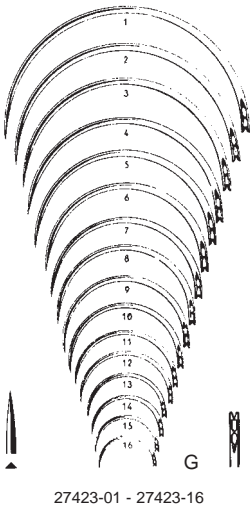
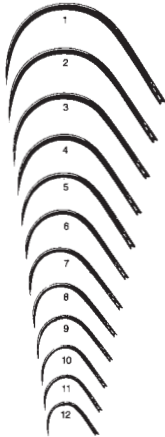

Fig. 1 2 3 4 5 6 7 8 9 10 11 12 13 14 15 16
 A 27403-01 27403-02 27403-03 27403-04 27403-05 27403-06 27403-07 27403-08 27403-09 27403-10 27403-11 27403-12 27403-13 27403-14 27403-15 27403-16
 B 27413-01 27413-02 27413-03 27413-04 27413-05 27413-06 27413-07 27413-08 27413-09 27413-10 27413-11 27413-12 27413-13 27413-14 27413-15 27413-16
 G 27423-01 27423-02 27423-03 27423-04 27423-05 27423-06 27423-07 27423-08 27423-09
 Ga 27433-01 27433-02 27433-03 27433-04 27433-05 27433-06 27433-07 27433-08 27433-09 27433-10 27433-11 27433-12 27433-13 27433-14 27433-15 27433-16
 Gr 27434-01 27434-02 27434-03 27434-04 27434-05 27434-06 27434-07 27434-08 27434-09 27434-10 27434-11 27434-12 27434-13 27434-14 27434-15 27434-16

Alle Nadeln mit Ohr
all the needles with spring eye
todas las agujas con ojo a resorte
tutti gli aghi con cruna aperta



Alle Nadeln mit Öhr
 all the needles with spring eye
 todas las agujas con ojo a resorte
 tutti gli aghi con cruna aperta



27441-01 - 27441-12

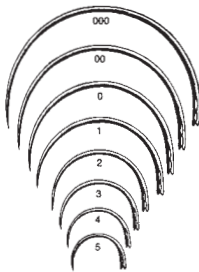

27443-30 - 27443-05

Chirurgische Nadeln
 Suturing Needles
 Aguja para suturas
 Aghi per suture

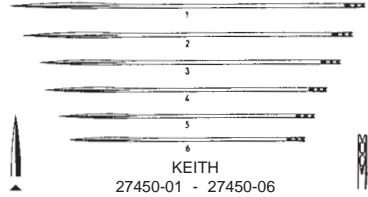

KEITH
 27450-01 - 27450-06



KEITH
 27452-01 - 27452-06

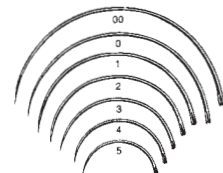

27465-20 - 27467-05

Pb

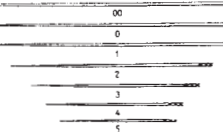

27475-20 - 27477-05

Pc

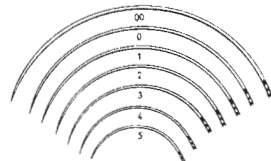

27485-20 - 27487-05

Pd

FIG.	000	00	0	1	2	3	4	5	6	7	8	9	10	11	12
KÖNIG				27441-01	27441-02	27441-03	27441-04	27441-05	27441-06	27441-07	27441-08	27441-09	27441-10	27441-11	27441-12
E	27443-30	27443-20	27443-10	27443-01	27443-02	27443-03	27443-04	27443-05							
KEITH				27450-01	27450-02	27450-03	27450-04	27450-05	27450-06						
KEITH				27452-01	27452-02	27452-03	27452-04	27452-05	27452-06						
Pb		27465-20	27465-10	27467-01	27467-02	27467-03	27467-04	27467-05							
Pc		27475-20	27475-10	27477-01	27477-02	27477-03	27477-04	27477-05							
Pd		27485-20	27485-10	27487-01	27487-02	27487-03	27487-04	27487-05							

Nahtinstrumente und Wundklammern
 Clips and Instruments
 Agrafes e instrumentos
 Agrafes e strumenti

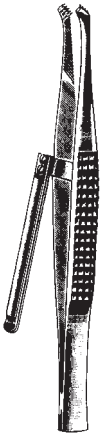

CHILDE
 27620-18
 18 cm, 7"



MICHEL
 27610-12
 12 cm, 4 3/4"



WACHENFELDT
 27612-12
 12,5 cm, 5"



WACHENFELDT
 27614-12
 12,5 cm, 5"



HEGENBARTH
 27616-12
 12,5 cm, 5"



MICHEL
 27630-12
 12 cm, 4 3/4"



COLLIN
 27640-13
 13 cm, 5 1/4"

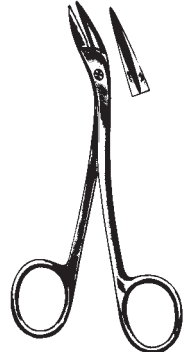

RICHTER-HEATH
 27642-14
 14 cm, 5 1/2"



MICHEL

- MICHEL mm
- 27660-07 7,5x1,75
- 27660-11 11x2
- 27660-12 12x3
- 27660-14 14x3
- 27660-16 16x3
- 27660-18 18x3
- 27660-20 20x3
- 27660-22 22x3

Pack à 1000
 box of 1000
 paq x 1000
 confezione x 1000

Taschenbestecke
 Pocket, Suturing Kits
 Estuche de bolsillo y de sutura
 Astucci tascabili e per sutura

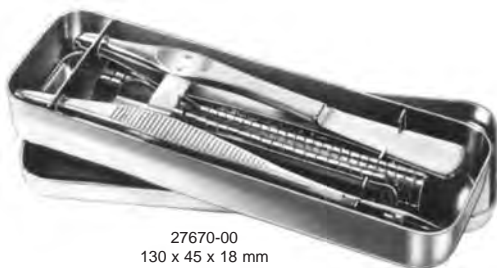

27670-00
 130 x 45 x 18 mm

Wundnahtbesteck in Metall-Etui,
 bestehend aus:
 Michel Wundklammerzängchen
 Wachenfeldt Faßpinzette
 50 Michel Wundklammern

Estuche para sutura, en caja de metal,
 compuesto de:
 Pinza para agrafes de Michel
 Pinza para juntar los bordes de la herida,
 de Wachenfeldt, con porta-agrafas
 50 Agrafes (Grapas) de Michel

Suture Clip set in metal case,
 consisting of:
 Suture Clip Forceps Michel
 Approximation Forceps, Wachenfeldt,
 with clip rack
 50 suture clips Michel

Set di clip per suture in astuccio di metallo
 composto da:
 Pinza di Michel per clip
 Pinza Wachenfeldt con fermagli per sutura
 50 Agrafes di Michel

Taschenbestecke
 Pocket, Suturing Kits
 Estuche de bolsillo y de sutura
 Astucci tascabili e per sutura



STANDARD

27680-00
 165 x 90 x 28 mm

Komplett in Metalletui und Plastiktasche mit 2 herausnehmbaren gelochten Einlagen mit Stegen für Instrumente

Bestehend aus:

- 1 Mathieu Nadelhalter 14 cm (5½")
- 1 Nähseide in Alkohol
- 6 Nähnadeln sortiert
- 1 Nadeldose gelocht 65 x 42 cm
- 1 Michel Wundklammerzange
- 20 Wundklammern auf Halter
- 1 Skalpellgriff mit Klinge
- 3 Klängen auswechselbar
- 1 Schere st/sp. 13 cm (5") gerade
- 1 anat. Pinzette 11,5 cm (4½")
- 1 Hakenpinzette 1 x 2 Z. 12 cm (4¾")
- 1 Hunter Splitterpinzette 10,5 cm (4¼")
- 1 Kocher Arterienklemme 13 cm (5")
- 1 Myrtenblattsonde 13 cm (5")

Complete in metal case with plastic pouch and 2 removable perforated trays for instruments

Contents:

- 1 Mathieu Needle Holder, 14 cm (5½")
- 1 Flacon with sterilized silk in alcohol
- 6 Suture Needles, assorted
- 1 Needle Case, 25,6" x 16,5", perforated
- 1 Michel Suture Clip Forceps
- 20 Michel Suture Clips with Clip Holder
- 1 Scalpel Handle with Blade
- 3 Scalpel Blades, interchangeable
- 1 Scissors, straight, blunt/sharp, 13 cm (5")
- 1 Dressing Forceps, 11,5 cm (4½")
- 1 Tissue Forceps, 12 cm (4¾"), 1 x 2 teeth
- 1 Hunter Splinter Forceps, 10,5 cm (4¼")
- 1 Kocher Artery Forceps, straight, 13 cm (5"), S
- 1 Probe with myrtle leaf, 13 cm (5")

Completo en caja de metal con bolsa de plástico y 2 bandejas perforadas para los instrumentos

Contenido:

- 1 Porta-aguja de Mathieu, 14 cm (5½")
- 1 Frasco con seda esterilizada para sutura, en alcohol
- 6 Agujas de sutura surtidas
- 1 Cajita para agujas, 65 x 42 mm, perforada
- 1 Pinza para agrafes de Michel
- 20 Agrafes de Michel, en su porta-agrafes
- 1 Mango de bisturi, con hoja intercambiable
- 3 Hojas intercambiables surtidas
- 1 Tijera, recta, roma/aguda, 13 cm (5")
- 1 Pinza de disección, 11,5 cm (4½")
- 1 Pinza de disección, con 1 x 2 dientes, 12 cm (4¾")
- 1 Pinza para espinas de Hunter, 10,5 cm (4¼")
- 1 Pinza hemostática de Kocher, 13 cm (5"), S.
- 1 Estilote abotonado, multiforme, 13 cm (5")

Astuccio tascabile con due supporti estraibili

Contenente:

- 1 Port aghi di Mathieu 14 cm (5½")
- 1 Set per suture in flacone di vetro
- 6 aghi per sutura assortiti
- 1 scatola per aghi 65 x 24 perforata
- 1 pinza per sutura di Michel
- 20 Agrafe Michel ed porta agrafe
- 1 Manico da bisturi per lama intercambiabile
- 3 lame da bisturi intercambiabili
- 1 forbici rette alterne 13 cm (5")
- 1 pinze da dissezione
- 1 pinze da dissezione 1 x 2 denti
- 1 pinze di Hunter per schegge 10,5 cm (4¼")
- 1 pinze emostatiche di Kocher 13 cm (5")
- 1 specillo bottonuto 13 cm (5")

Sterilisierzangen, Abfallzange, Sterilisierklammern
 Sterilization Instruments, Waste Forceps, Safety pins
 Instrumentos para la esterilización, Pinza para desechos, Cadres de estérilización,
 Pinze per la sterilizzazione, Pinza per rifiuti, Spilloni p. sterilizzazione



DAVIS
 29102-16 16 cm, 6 1/4"
 29102-20 20 cm, 8"
 29102-24 24 cm, 9 1/2"

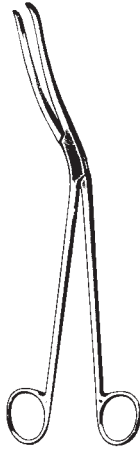

CHEATELE
 29110-27
 27 cm, 10 1/2"

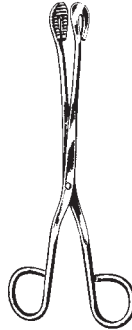

UNIVERSAL
 29120-20 20 cm, 8" 29121-20
 29120-28 28 cm, 11" 29121-28

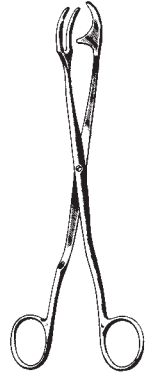

ROGGE
 29130-23
 23 cm, 9"



MAYO
 29140-20 20 cm, 8"
 29140-30 30 cm, 11 3/4"



SAUERBRUCH
 29145-55
 55 cm, 21.7"



BUNT
 29150-12 12 cm, 4 3/4"

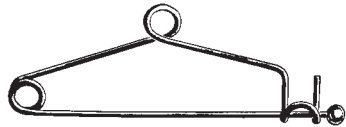

MAYO
 29152-14 14 cm, 5 1/2"

Gipsscheren
Plaster of Paris Shears
Cizallas para vendajes enyesados
Cesoie per gessi

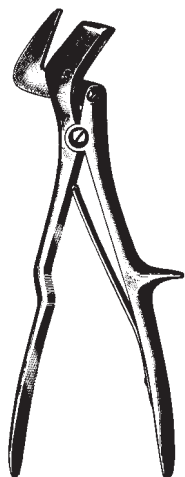

STILLE
31101-24 24 cm, 9 1/2"



STILLE
31103-23 23 cm, 9"
31103-26 26 cm, 10 1/2"
31103-37 37 cm, 14 1/2"



Gipsmesser
plaster knife
cuchillo para vendajes enyesados
coltello da gesso

WIGMORE
31120-19 19 cm, 7 1/2"

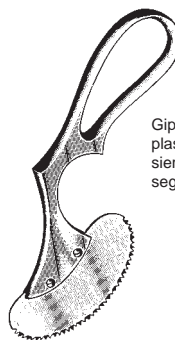

Gipssäge
plaster saw
sierra para vendajes enyesados
sega da gesso

ENGEL
31130-14
verchromt

Oscillierende Gipssäge
 Oscillating Plaster Saw
 Sierra oscilante p. vendajes enyesados
 Segga oscillante per gessi

Elektrische Gipssäge
 Electric Plaster Cast Cutter
 Sierra eléctrica para yesos
 Segga elettrica per gessi



31210-21 110 Volt, compl. of Art.-Nr. 31212-02/31210-50/31210-65
 31210-22 230 Volt, compl. of Art.-Nr. 31212-02/31210-50/31210-65

Geräuschpegel min. 63 max. 69 DB
 Noise level machine only: Min. 63 Max. 69 db/(A)
 Nivel de ruido del aparato sólo 63 dB (mín.), 69 dB/(A)
 Livello acustico dello strumento solo: min. 63 max. 69 db/(A)

EN 60601-1, EN 60601-1-2, IEC 60601-1, IEC 60601-1-2

31212-02
 Schlüsselpaar
 pair of screw driver
 par le Llave
 paio di chiavi

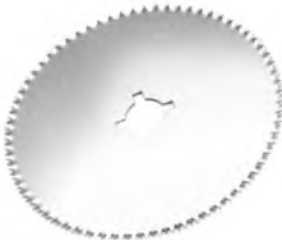

31210-50 50 mm (2.0") Ø weich *
 31210-65 65 mm (2.6") Ø weich *
 31211-50 50 mm (2.0") Ø hart *
 31211-65 65 mm (2.6") Ø hart *

- * Ersatz-Sägeblätter, spezialgehärtet (F. Fiberglas u. andere Hartverbände)
- * Spare saw blades, special hardness (for dressing of fiber glass for other hard dressing)
- * Hojas de repuesto, templadas especialmente (para vendajes de fibra de vidrio y otros vendajes duros)
- * Lame per segga a tempera speciale per bendaggi (in fibro di vetro ed altri bendaggi duri)

Oscillierende Gipssäge mit Staubabsauger
Oscillating Plaster Saw with plaster vacuum
Sierra oscillante con aspiración
Sega oscillante per gesso con aspirazione



Autopsiesäge
 Autopsy saw
 Sierra para autopsia
 Sega per autopsia

Schnellspannfutter
 Quick-action chuck
 tuerca de fijación rapida
 Mandrino rapido



31201-11 110 Volt, ohne Zubehör / without accessory / sin accesorio / senza accessori
 31201-22 230 Volt, ohne Zubehör / without accessory / sin accesorio / senza accessori

Geräuschpegel min. 63 max. 69 DB
 Noise level machine only: Min. 63 Max. 69 db/(A)
 Nivel de ruido del aparato sólo 63 dB (min.), 69 dB/(A)
 Livello acustico dello strumento solo: min. 63 max. 69 db/(A)

EN 60601-1, EN 60601-1-2, IEC 60601-1, IEC 60601-1-2

Zubehör zur Autopsiesäge
 Accessories for Autopsy saw
 Accesorio para la sierra de autopsia
 Accessori per sega per autopsia



Segmentsäge

besteht aus:
 1 x 31204-01 Segment-Sägeblatt
 1 x 31201-39 Schaft 39 mm

Segment saw

consisting of:
 1 x 31204-01 segment saw
 1 x 31201-39 arbor 39 mm

Sierra para segmento

compuesto de:
 1 x 31204-01 hoja de sierra
 1 x 31201-39 vastago 39 mm

Sega a segmento

composta da:
 1 x 31204-01 Lama a segmento
 1 x 31201-39 Asta 39 mm



Tiefensäge

besteht aus:
 1 x 31205-20 Tiefen-Sägeblatt, 20 mm
 1 x 31201-39 Schaft 39 mm

Deep cutting saw

consisting of:
 1 x 31205-20 depp cutting saw, 20 mm
 1 x 31201-39 arbor 39 mm

Sierra de profundidad

compuesto de:
 1 x 31205-20 hoja de sierra, 20 mm
 1 x 31201-39 vastago 39 mm

Sega a taglio di profondità

composta da:
 1 x 31205-20 Lama a taglio di profondità, 20 mm
 1 x 31201-39 Asta 39 mm



Tiefensäge schmal

besteht aus:
 1 x 31205-08 Tiefen-Sägeblatt, 8 mm
 1 x 31201-39 Schaft 39 mm

Deep cutting saw narrow

consisting of:
 1 x 31205-08 depp cutting saw, 8 mm
 1 x 31201-39 arbor 39 mm

Sierra de profundidad, estrecha

compuesto de:
 1 x 31205-08 hoja de sierra, 8 mm
 1 x 31201-39 vastago 39 mm

Sega a taglio sottile di profondità

composta da:
 1 x 31205-08 Lama a taglio di profondità, 8 mm
 1 x 31201-39 Asta 39 mm



Kreissäge ø 65 mm

mit exzentrischer Begrenzungsscheibe für differenzierte Schnitt-Tiefe von 4 bis 11 mm,
 besteht aus:
 1 x 31210-65 Sägeblatt ø 65 mm
 1 x 31203-50 Begrenzungsscheibe
 1 x 31201-39 Schaft 39 mm

Circular saw ø 65 mm

with eccentric disk to limit depth of cut from 4 - 11 mm
 consisting of:
 1 x 31210-65 circular saw ø 65 mm
 1 x 31203-50 limiting disc
 1 x 31201-39 arbor 39 mm

Sierra circular ø 65 mm

con disco de tope excentrico para diferentes cortes de profundidad de 4 mm hasta 11 mm
 compuesto de:
 1 x 31210-65 hoja de sierra, ø 65 mm
 1 x 31203-50 disco de tope
 1 x 31201-39 vastago 39 mm

Sega circolare diam. 65 mm

con disco di limitazione eccentrico per taglio differenziato dal 4 mm al 11 mm,
 composta da:
 1 x 31210-65 Lama circolare, ø 65 mm
 1 x 31203-50 Disco eccentrico
 1 x 31201-39 Asta 39 mm

Zubehör zur Autopsiesäge
 Accessories for Autopsy saw
 Accesorio para la sierra de autopsia
 Accessori per sega per autopsia



31201-39
 Schaft, 39 mm lang
 arbor, 39 mm
 vástago, 39 mm de largo
 asta, lunghezza 39 mm



31201-58
 Schaft, 58 mm lang
 arbor, 58 mm
 vástago, 58 mm de largo
 asta, lunghezza 58 mm



31202-16
 Imbusschlüssel mit T-Griff zum Befestigen des Bohrfutters
 Alan key wit T-handle
 Llave hexagonal con mango de T para fijacion del taladro
 Chiave esagonale con manico a T per fissaggio del mandrino



31212-02
 Schlüsselpaar zum Auswechseln der Sägeblätter
 pair of screw driver
 par de llave para cambiar las hojas de sierra
 Paio di chiavi per cambio delle lame

Gipsspreizer, Gipsabreißzangen
 Plaster Cast Instruments
 Instrumentos para vendajes enyesados
 Allargagessi, Strappagessi

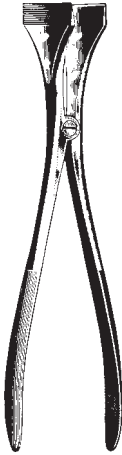

HENNIG
 31350-28 28 cm, 11"



BEESON
 31360-30 30 cm, 11 3/4"

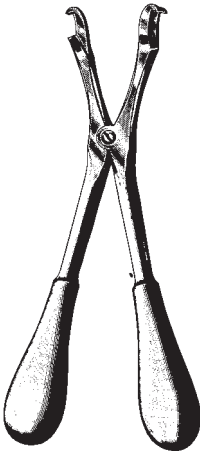

HAGLUND-STILLE
 31362-28 28 cm, 11"



REDA
 31366-23 23 cm, 9"

Gipsspreizer, Gipsmesser, Gipsabreißzangen
 Plaster Cast Instruments, Knives
 Instrumentos para vendajes enyesados, Cuchillos
 Allargagessi, Coltelli per Gessi, Strappagessi



HOPKINS
 31370-20
 20 cm, 8"



ESMARCH
 31380-18
 18 cm, 7"



REINER
 31390-18
 18 cm, 7"



WOLFF
 31395-18
 18 cm, 7"



WOLFF
 31397-24
 24 cm, 9 1/2"

Hohlmeißelzangen
 Bone Rongeurs
 Pinzas-gubias
 Pinze sgorbie

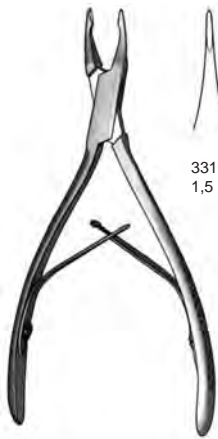

33100-01
 1,5 x 5 mm



33100-02
 1,5 x 5 mm



FRIEDMAN Mini
 33101-12 12 cm, 4 3/4"



3,5 mm

FRIEDMAN
 33101-14 14 cm, 5 1/2"



33102-01
 2 mm



33102-02
 2 mm

STELLBRINK
 33102-02 17 cm, 6 3/4"

Hohlmeißelzangen
 Bone Rongeurs
 Pinzas-gubias
 Pinze sgorbie

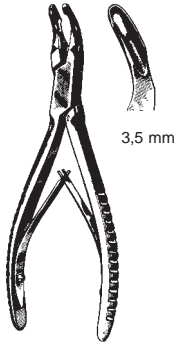

CLEVELAND
 33103-14 14 cm, 5 1/2"

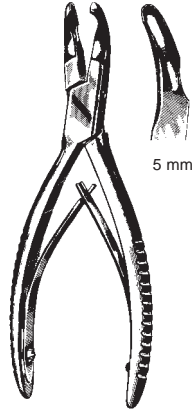

CLEVELAND
 33105-17 17 cm, 6 3/4"

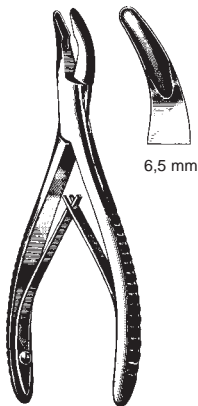

MEAD
 33107-16 16,5 cm, 6 1/2"

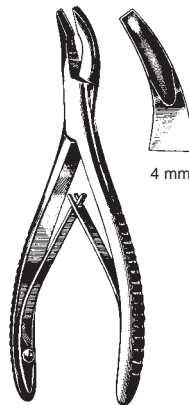

MEAD
 33109-16 16,5 cm, 6 1/2"

Hohlmeißelzangen
 Bone Rongeurs
 Pinzas-gubias
 Pinze sgorbie

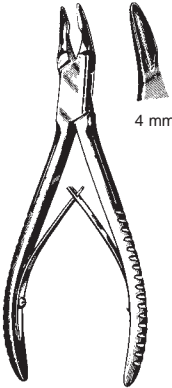

4 mm

BLUMENTHAL
 33115-15
 15,5 cm, 6"

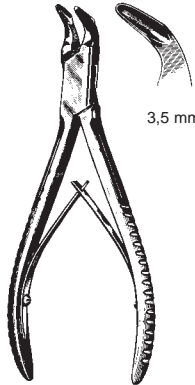

3,5 mm

BLUMENTHAL
 33117-15
 15,5 cm, 6"

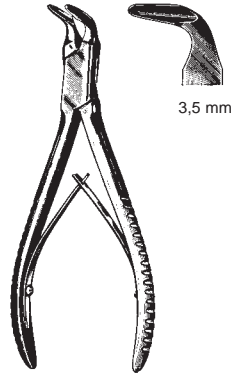

3,5 mm

BLUMENTHAL
 33119-15
 15,5 cm, 6"

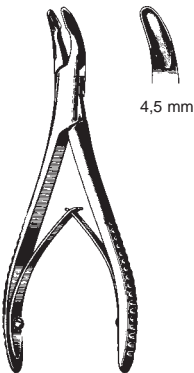

4,5 mm

LUER
 33131-15
 15 cm, 5.9"

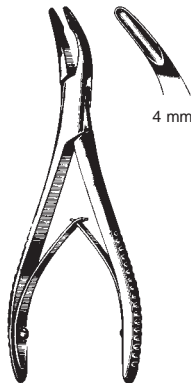

4 mm

LUER
 33133-15
 15 cm, 5.9"

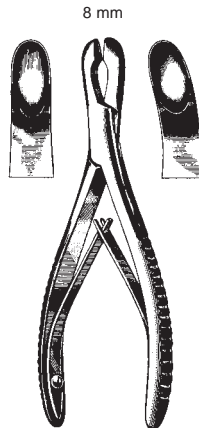

8 mm

LUER
 33136-17 33137-17
 17 cm, 6 3/4"

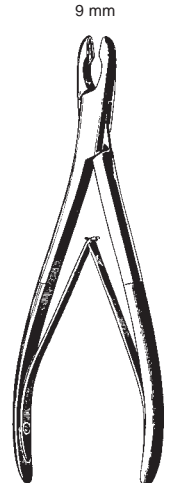

9 mm

ADSON
 33142-20 33143-20
 20 cm, 7.9"

Hohlmeißelzangen
Bone Rongeurs
Pinzas-gubias
Pinze sgorbie

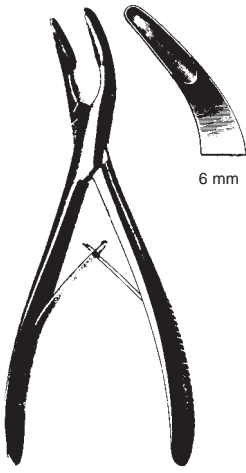

OLIVECRONA
33147-20
20 cm, 7.9"

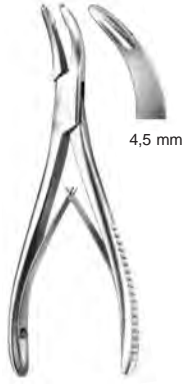

BANE-HARTMANN
33148-18
17.5 cm, 7"



LEMPERT
33150-16 33151-16
16 cm, 6 1/4"



JANSEN
17 cm, 6 3/4"



LEMPERT
33154-18 33155-18
18.5 cm, 7 1/2"



BEYER
33156-18
18 cm, 7"

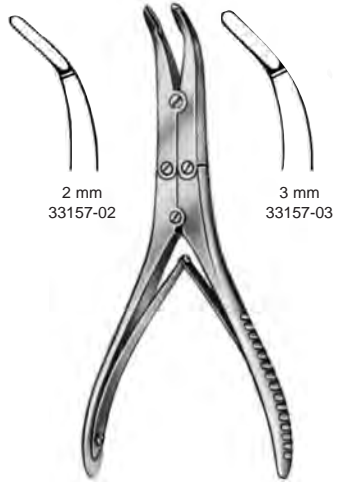

KLEINERT-KUTZ
15 cm, 6"

Hohlmeißelzangen
 Bone Rongeurs
 Pinzas-gubias
 Pinze sgorbie



3 mm
33157-04



4 mm
33157-05



5 mm
33157-06



3 mm
33158-03



4 mm
33158-04



5 mm
33158-05



3 mm
33159-03



4 mm
33159-04



5 mm
33159-05



SMITH-PETERSEN
 24 cm, 9 1/2"

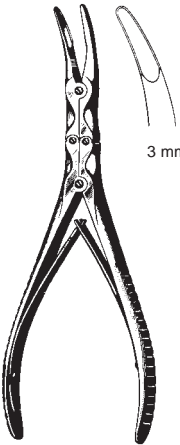

BEYER
 33201-18
 18 cm, 7"



MAYFIELD
 33202-18
 18 cm, 7"

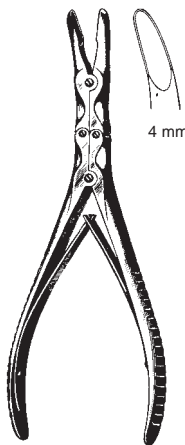

ZAUFAL-JANSEN
 33205-18
 18 cm, 7"

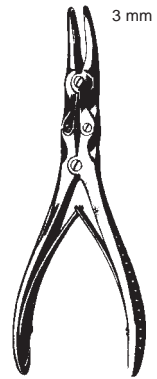

BOHLER
 33211-15 33213-15
 15 cm, 6"

Hohlmeißelzangen
 Bone Rongeurs
 Pinzas-gubias
 Pinze sgorbie

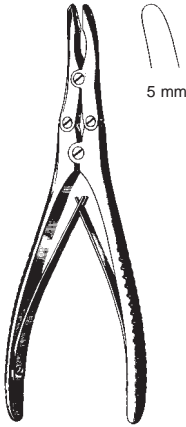

RUSKIN
 33216-18 33217-18
 18 cm, 7"

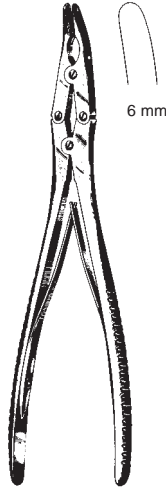

RUSKIN
 33219-23 23 cm, 9"



MARQUARDT
 33220-20 20 cm, 8"

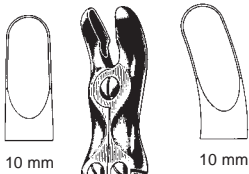

10 mm 10 mm

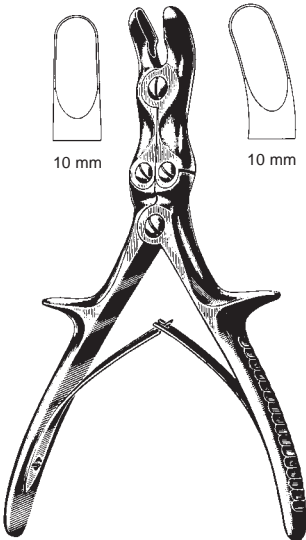

STILLE-LUER
 33230-22 22 cm, 8 3/4"
 33230-26 26 cm, 10 1/4" 33231-26

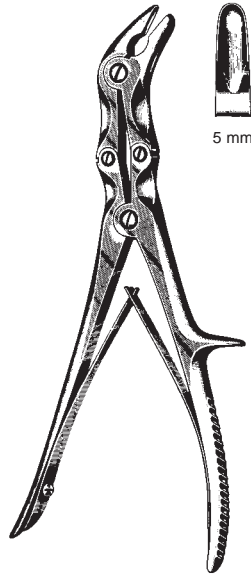

5 mm

STILLE-LUER
 33235-23
 23 cm, 9"

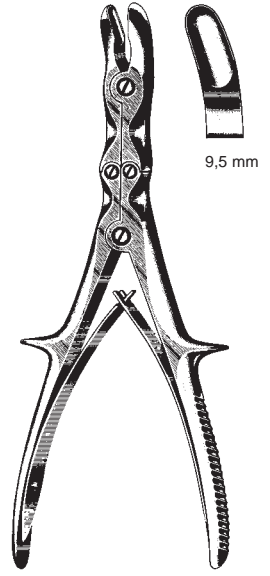

9,5 mm

STILLE-RUSKIN
 33237-23
 23 cm, 9"

Hohlmeißelzangen
 Bone Rongeurs
 Pinzas-gubias
 Pinze sgorbie

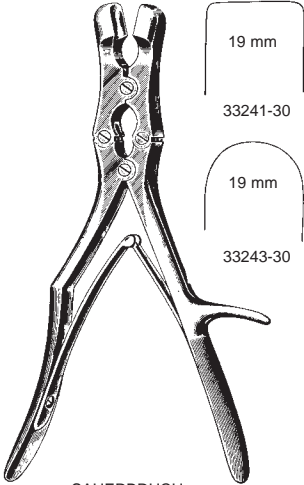

SAUERBRUCH
 30 cm, 10 3/4"

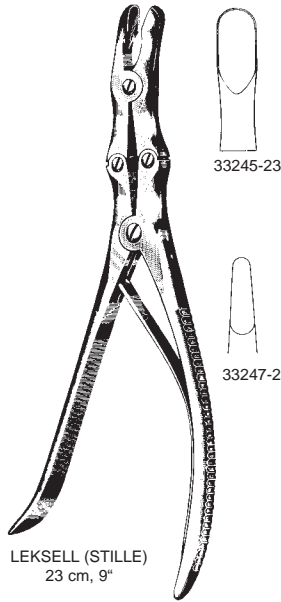

LEKSELL (STILLE)
 23 cm, 9"

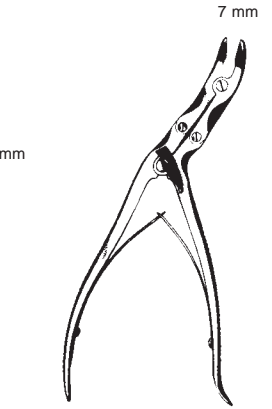

R SCAGLIETTI L
 33251-26 26 cm, 10 1/4" 33253-26
 rechts links
 right left
 derecha izquierda
 a destra a sinistra



ECHLIN
 33257-23 2 mm
 33258-23 4 mm
 33259-23 3 mm
 23 cm, 9"



FRYKHOLM
 33260-24
 24 cm, 9 1/2"

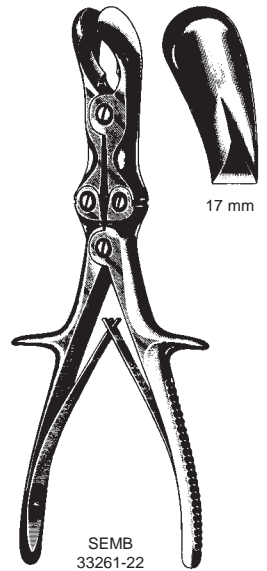

SEMB
 33261-22
 22,5 cm, 8.9"

Knochensplitterzangen
 Bone Cutting Forceps
 Pinzas cortantes para huesos
 Cesioie per ossa

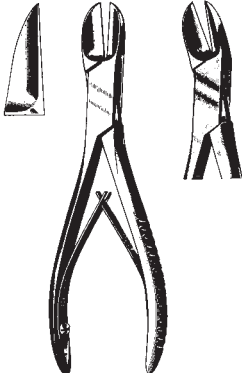

— LISTON —
 33274-14 14 cm, 5 1/2" 33275-14
 33274-17 17 cm, 6 3/4" 33275-17
 33274-19 19 cm, 7 1/2" 33275-19
 33274-22 22 cm, 8 3/4" 33275-22



— BÖHLER —
 33280-15 33281-15
 15 cm, 6"



— COTTLE-KAZANJIAN —
 33282-19
 19 cm, 7 1/2"



— MC INDOE —
 33283-17
 17 cm, 6 3/4"



— STAMM —
 33284-15
 15 cm, 6"

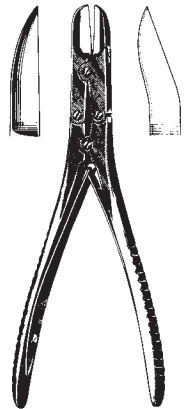

— RUSKIN-LISTON —
 33286-18 33289-18
 18 cm, 7"

Knochensplitterzangen
 Bone Cutting Forceps
 Pinzas cortantes para huesos
 Cesoie per ossa

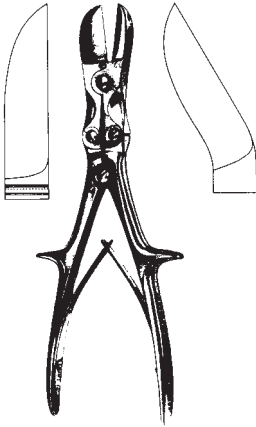

— STILLE-LISTON —
 33290-23 23 cm, 9" 33291-23
 33290-27 27 cm, 10 1/2" 33291-27



STILLE-LISTON
 33292-26
 26 cm, 10 1/4"

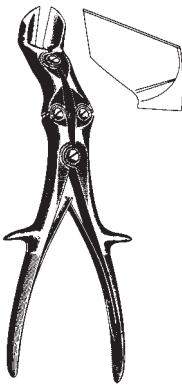

STILLE-HORSLEY
 33293-27
 27 cm, 10 1/2"

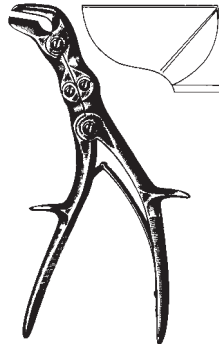

SEMB
 33295-24
 24 cm, 9 1/2"

Knochenhalte­zangen
Bone Holding Forceps
Pinzas para huesos
Tenaglie per ossa

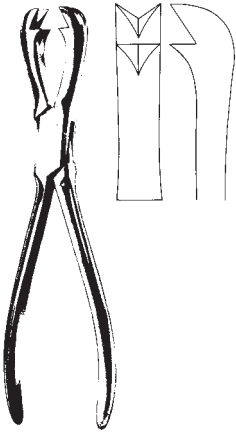

FERGUSSON
33360-21
21 cm, 8 1/4"

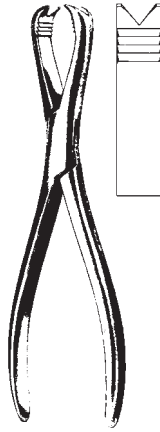

LANGENBECK
33362-21
21 cm, 8 1/4"

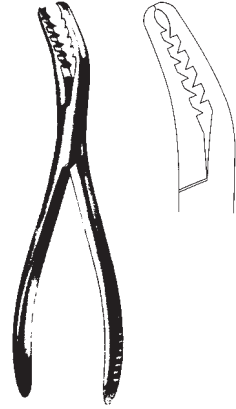

SEMB
33365-19 19 cm, 7 1/2"



SEMB
33366-19 20 cm, 8"
mit Sperre



FARABEUF
33366-23 23 cm, 9"
33366-26 26 cm, 10 1/4"



FARABEUF-LAMBOTTE
33368-26
26 cm, 10 1/4"

Knochenhalte­zangen
 Bone Holding Forceps
 Pinzas para huesos
 Tenaglie per ossa

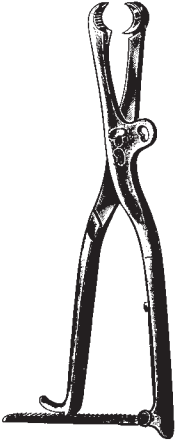

LAMBOTTE
 33370-22 22 cm, 8 3/4"
 33370-27 27 cm, 10 1/2"
 33370-30 30 cm, 11 3/4"

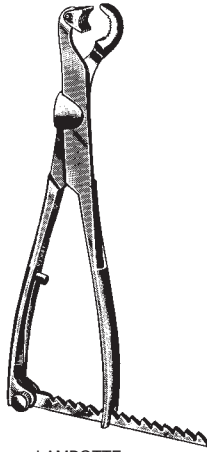

LAMBOTTE
 33372-22 22 cm, 8 3/4"
 33372-26 26 cm, 10 1/4"
 33372-33 33 cm, 13"

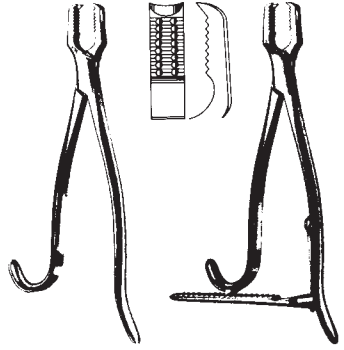

KERN
 33378-15 15 cm, 6" 33380-15
 33378-17 17 cm, 6 3/4" 33380-17
 33378-21 21 cm, 8 1/4" 33380-21

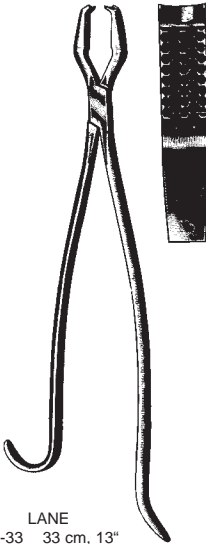

LANE
 33382-33 33 cm, 13"
 33382-45 45 cm, 17 3/4"

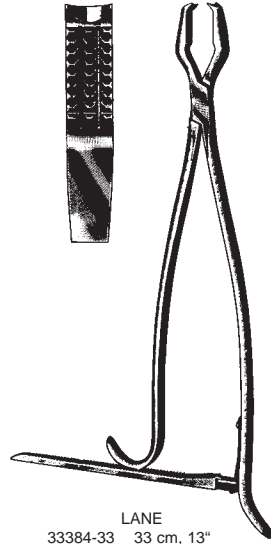

LANE
 33384-33 33 cm, 13"
 33384-45 45 cm, 17 3/4"

Knochenhaltezangen
 Bone Holding Forceps
 Pinzas para huesos
 Tenaglie per ossa

selbstzentrierend
 self-centering
 autocentrantes
 autocentranti

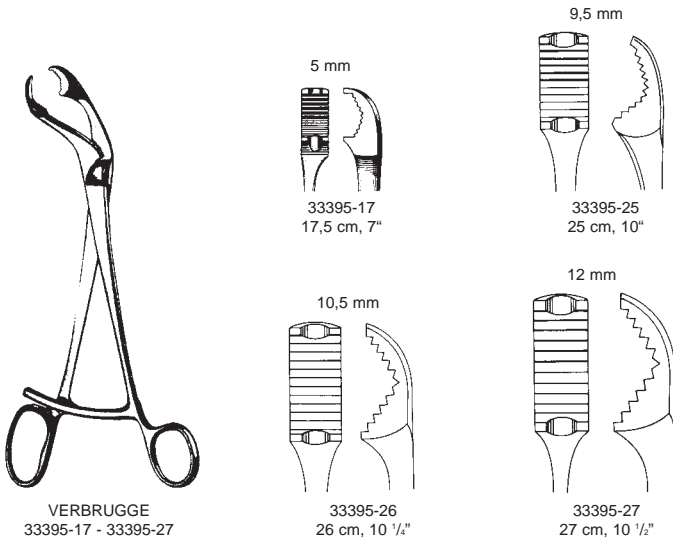
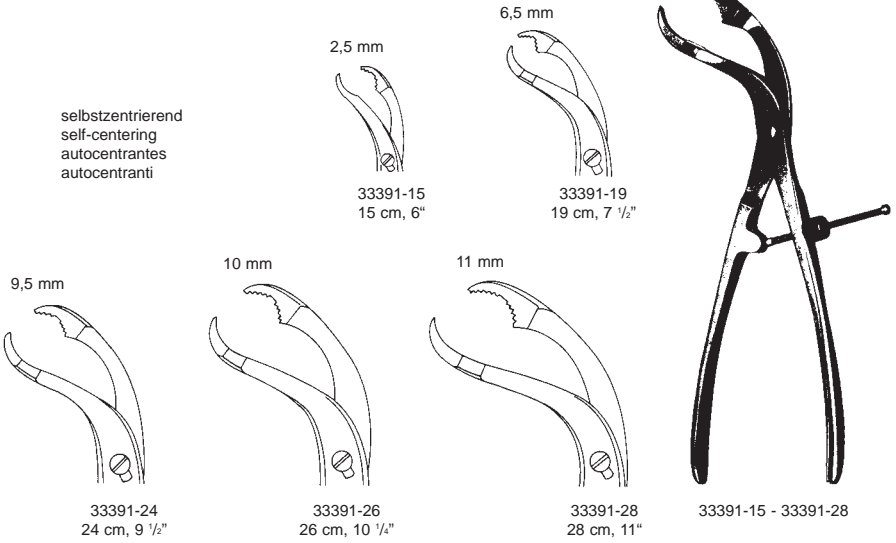

Knochenhaltezangen
 Bone Holding Forceps
 Pinzas para huesos
 Tenaglie per ossa

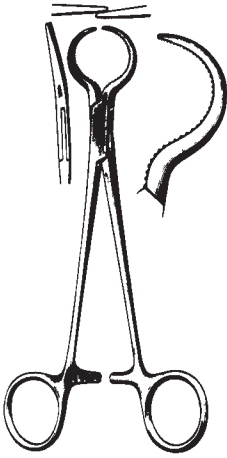

LEWIN
 33402-17
 17,5 cm, 7"



BIRCHER-GANSKE
 33404-20 33405-20
 20 cm, 8"



33406-20
 20 cm, 8"



DINGMANN
 33407-19
 19 cm, 7 1/2"



REDA
 33409-13
 13,5 cm, 5 1/2"



MARTIN
 33410-19
 19 cm, 7 1/2"

Knochenhaltezangen
 Bone Holding Forceps
 Pinzas para huesos
 Tenaglie per ossa



REDA
 33412-16 - 33412-24

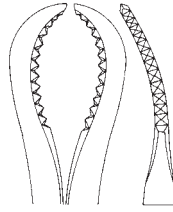

33412-16
 16 cm, 6 1/4"

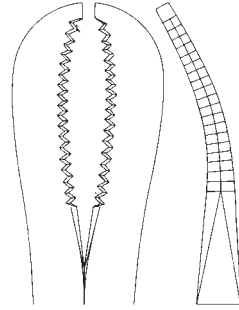

33412-24
 24 cm, 9 1/2"



REDA
 33413-14
 13,5 cm, 5 1/4"



33414-21
 21 cm, 8 1/4"

Knochenhaltezangen
 Bone Holding Forceps
 Pinzas para huesos
 Tenaglie per ossa



ULRICH
 33415-23 - 33415-28



33415-23
 23 cm, 9"



33415-25
 25 cm, 10"



33415-28
 28 cm, 11"

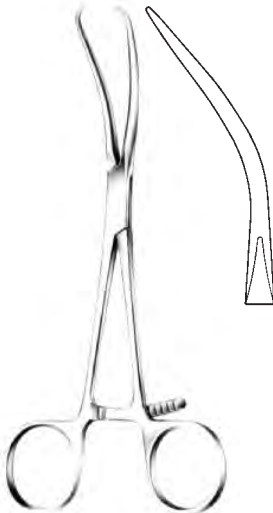

REILL
 33416-17
 17 cm, 6 3/4"



PATELLA
 33417-18
 18,5 cm, 7 1/2"

Knochenhaltezangen, -Klammern
 Bone holding forceps, -Clamps
 Pinzas para huesos, Clamps porta-huesos
 Tenaglie per ossa, Pinze per ossa

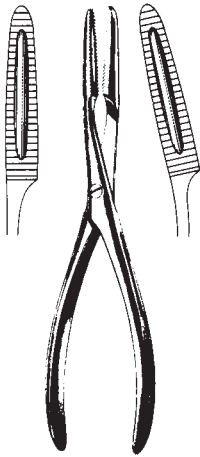

33420-20 33421-20
 20 cm, 8"

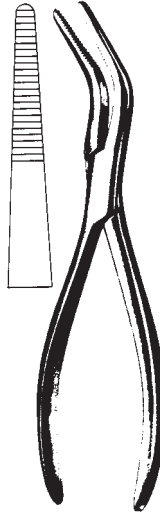

VAN BUREN
 33423-23
 23 cm, 9"



FELDHEIM
 33424-10
 10 cm, 4"



LOWMAN
 33441-13 13 cm, 5 1/8"
 33441-18 18 cm, 7"
 33441-20 20 cm, 8"



LOWMAN-HOGLUND
 33442-19
 19 cm, 7 1/2"

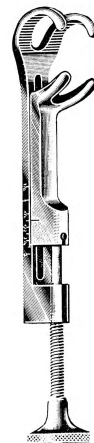

LAMBERT-LOWMAN
 33443-18
 18 cm, 7"

Knochenhaltezangen, Bleihand
 Bone holding forceps, Lead Hands
 Pinzas para huesos, Manoplas de plomo
 Tenaglie per ossa, Mani di piombo

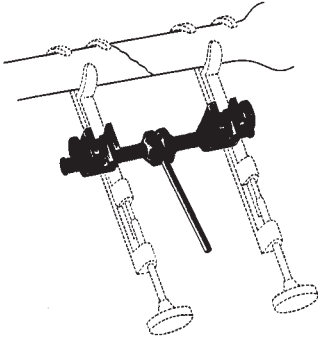

GERSTER
 33444-15



33450-01
 32 cm, 12 3/4"
 Erwachsen
 adult size
 p. adultos
 p. adulti

33450-02
 24 cm, 9 1/2"
 Kind
 child size
 p. niños
 p. bambini

Scharfe Löffel
Bone Curettes
Cucharillas cortantes
Curette taglianti

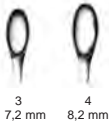
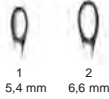

SCHEDE	Fig.	VOLKMANN
33467-97	0000	33469-96
33467-98	000	33469-97
33468-00	00	33469-98
33468-01	0	33470-00
33468-02	1	33470-01
33468-03	2	33470-02
33468-04	3	33470-03
	4	33470-04
	5	33470-05
	6	33470-06

SCHEDE
17 cm, 6 3/4"

33467-97 - 33468-04

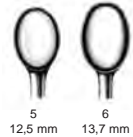
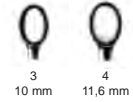

VOLKMANN
17 cm, 6 3/4"

33469-96 - 33470-06

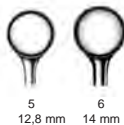
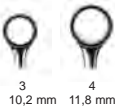
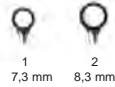

BRUNS	Fig.	SPRATT
33471-96	0000	33474-96
33471-97	000	33474-97
33471-98	00	33474-98
33472-00	0	33475-00
33472-01	1	33475-01
33472-02	2	33475-02
33472-03	3	33475-03
33472-04	4	33475-04
33472-05	5	33475-05
33472-06	6	33475-06

BRUNS
17 cm, 6 3/4"

33471-96 - 33472-06

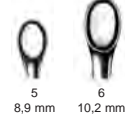
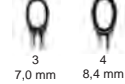
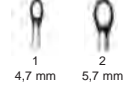
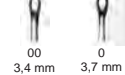
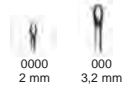

SPRATT
17 cm, 6 3/4"

33474-97 - 33475-06

Scharfe Löffel
 Bone Currettes
 Cucharillas cortantes
 Curette taglienti



COBB
 27,9 cm 11"

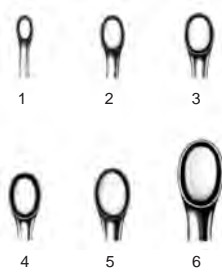

Fig.
 1 33473-01 3,5 mm
 2 33473-02 4,5 mm
 3 33473-03 5,5 mm
 4 33473-04 7,5 mm
 5 33473-05 8,5 mm
 6 33473-06 10,0 mm

Scharfe Löffel
Bone Curettes
Cucharillas cortantes
Curette taglienti

Fig.
1 33476-01 4,8 mm
2 33476-02 5,8 mm
3 33476-03 6,8 mm

biegsam
malleable
maleable
malleabile

HALLE
21 cm, 8 1/4"
33476-01 - 33476-02

Fig.
000 33476-98 2,8 mm
00 33476-99 3,3 mm
0 33477-00 3,7 mm
1 33477-01 4,3 mm
2 33477-02 4,8 mm
3 33477-03 5,6 mm
4 33477-04 6,1 mm
5 33477-05 6,7 mm
6 33477-06 8,8 mm

SPINAL
20 cm, 8"
33476-98 - 33477-06

Fig.
000 33478-98 2,8 mm
00 33478-99 3,3 mm
0 33479-00 3,7 mm
1 33479-01 4,3 mm
2 33479-02 4,8 mm
3 33479-03 5,6 mm
4 33479-04 6,1 mm
5 33479-05 6,7 mm
6 33479-06 8,8 mm

SPINAL
20 cm, 8"
33478-98 - 33479-06

Fig.
33482-01 4,7 mm
33482-02 4,7 mm
33482-03 4,7 mm

SCOVILLE
25 cm, 10"
33482-01 - 33482-03

Scharfe Löffel
 Bone Currettes
 Cucharillas cortantes
 Curette taglienti

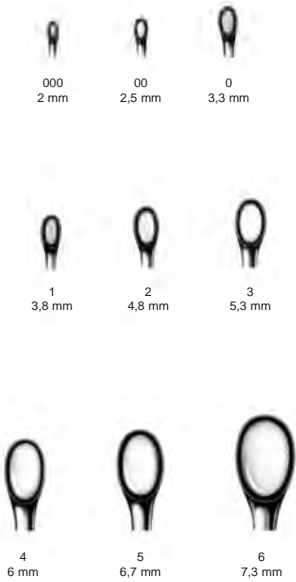

BRUNS
 23 cm, 9"



BRUNS
 23 cm, 9"



BRUNS
 23 cm, 9"

Fig.
 000
 00
 0
 1
 2
 3
 4
 5
 6

33480-97
 33480-98
 33481-00
 33481-01
 33481-02
 33481-03
 33481-04
 33481-05
 33481-06

33482-97 2,8 mm
 33482-98 3,3 mm
 33483-00 3,7 mm
 33483-01 4,3 mm
 33483-02 4,8 mm
 33483-03 5,6 mm
 33483-04 6,1 mm
 33483-05 6,7 mm
 33483-06 8,8 mm

33484-97 2,8 mm
 33484-98 3,3 mm
 33485-00 3,7 mm
 33485-01 4,3 mm
 33485-02 4,8 mm
 33485-03 5,6 mm
 33485-04 6,1 mm
 33485-05 6,7 mm
 33485-06 8,8 mm

Scharfe Löffel
Bone Curettes
Cucharillas cortantes
Curette taglienti



33485-21 21 cm, 8 1/4"
oval/rund
ovale/ronde
ovalado/redondo
ovale/rotonda



WILLIGER
17,5 cm
7"

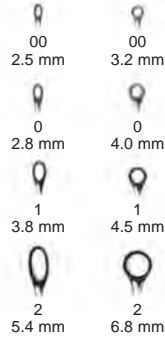
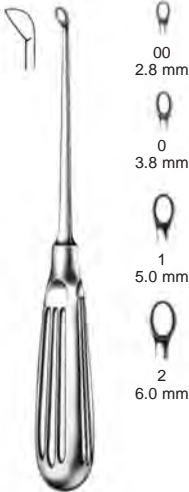

Fig. 00	33485-99	33486-99
0	33486-00	33487-00
1	33486-01	33487-01
2	33486-02	33487-02



DAUBENSPECK	Fig. 00	33487-99
20 cm, 8"	0	33488-00
	1	33488-01
	2	33488-02



27 cm	Fig. 0	33489-00
10 1/2"	1	33489-01
	2	33489-02
	3	33489-03

Scharfe Löffel
 Bone Currettes
 Cucharillas cortantes
 Curette taglienti



LEMPERT
 17,5 cm, 7"



0



00



000



0000



00000

Fig. 0	33490-10	3,3 mm
00	33490-20	3,0 mm
000	33490-30	2,7 mm
0000	33490-40	2,4 mm
00000	33490-50	2,0 mm



REDA
 25 cm, 10"



000
 3,6 mm



00
 4,4 mm



0
 5,2 mm



1
 6,8 mm

Fig. 000	33491-05
00	33491-06
0	33491-07
1	33491-08



REDA
 25 cm, 10"



000
 3,6 mm



00
 4,4 mm



0
 5,2 mm

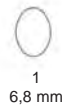

1
 6,8 mm

Fig. 000	33500-01
00	33500-02
0	33500-03



BUSHE
 25 cm, 10"



000
 3 mm



00
 4 mm



0
 5 mm

Fig. 000	33491-01
00	33491-02
0	33491-03
1	33491-04

Scharfe Löffel
Bone Curettes
Cucharillas cortantes
Curette taglienti



33492-13 6.3 mm
33492-16 7.0 mm
33492-20 9.1 mm

33492-13 6.8 mm
33492-16 9.0 mm
33492-20 11.1 mm

VOLKMANN

33492-13 13 cm, 5 1/8"
33492-16 16 cm, 6 1/2"
33492-20 20 cm, 8"



33494-13 7.5 mm
33494-14 6.8 mm
33494-17 6.8 mm

33494-13 6.3 mm
33494-14 6.2 mm
33494-17 7.3 mm

VOLKMANN

33494-13 13 cm, 5 1/8"
33494-14 14 cm, 5 1/2"
33494-17 17 cm, 6 3/4"



3.5 mm

5.2 mm

JANSE

33495-16
16 cm, 6 1/2"

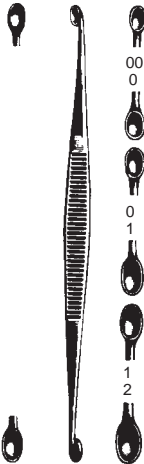

00 2.5 mm
0 3.0 mm

0 3.0 mm
1 3.5 mm

1 3.5 mm
2 4.0 mm

WILLIGER

13,5 cm, 5 1/2" Fig.
33496-00 00/0
33496-01 0/1
33496-12 1/2



4.0 mm

3.4 mm

JACOBSON

13 cm, 5 1/8"
33497-00

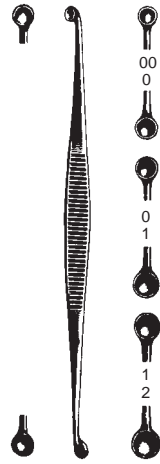

00 2.5 mm
0 3.1 mm

0 3.1 mm
1 3.5 mm

1 3.5 mm
2 4.0 mm

MARTINI

13,5 cm, 5 1/2"
33498-00
33498-01
33498-12

Stößel
Hemostats
Hemostáticos
Pistoni



CASPAR
200 mm, 8"

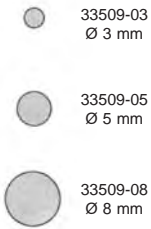

200 mm, 8"

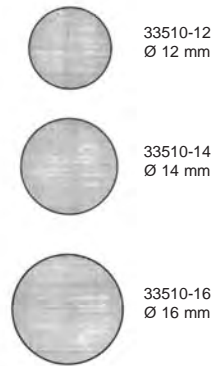

Stößel, Flachmeißel, Hohlmeißel
 Hemostats, Chisels, Gouges
 Hemostáticos, Cinceles, Gubias
 Pistoni, scalpelli, sgorbie

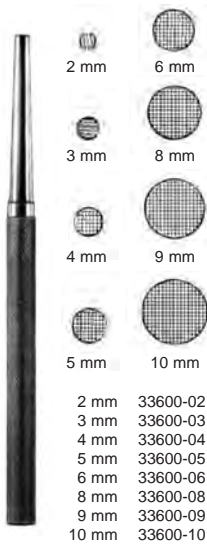

16 cm, 6 1/4"

2 mm	33600-02
3 mm	33600-03
4 mm	33600-04
5 mm	33600-05
6 mm	33600-06
8 mm	33600-08
9 mm	33600-09
10 mm	33600-10



13,5 cm, 5 1/4"

4 mm	33602-04
6 mm	33602-06
8 mm	33602-08
10 mm	33602-10
12 mm	33602-12
14 mm	33602-14
16 mm	33602-16



13,5 cm, 5 1/4"

33604-04
33604-06
33604-08
33604-10
33604-12
33604-14
33604-16



13,5 cm, 5 1/4"

33605-04
33605-06
33605-08
33605-10
33605-12
33605-14
33605-16



ALEXANDER

17 cm, 6 3/4"

33610-04	4 mm
33610-06	6 mm
33610-08	8 mm
33610-10	10 mm
33610-12	12 mm
33610-14	14 mm



ALEXANDER

17 cm, 6 3/4"

33611-04	4 mm
33611-06	6 mm
33611-08	8 mm
33611-10	10 mm
33611-12	12 mm
33611-14	14 mm



PARTSCH

13,5 cm, 5 1/4" mm 17 cm, 6 3/4"

33620-02	2	33622-02
33620-03	3	33622-03
33620-04	4	33622-04
33620-05	5	33622-05
33620-06	6	33622-06
33620-07	7	33622-07
33620-08	8	33622-08



PARTSCH

13,5 cm, 5 1/4" mm 17 cm, 6 3/4"

33623-02	2	33625-02
33623-03	3	33625-03
33623-04	4	33625-04
33623-05	5	33625-05
33623-06	6	33625-06
33623-07	7	33625-07
33623-08	8	33625-08

Flachmeißel, Hohlmeißel
 Chisels, Gouges
 Cinceles, Gubias
 Scalpelli, sgorbie



PASSOW
 12 cm, 4 1/4"
 33626-35 3,5 mm
 33626-25 2,5 mm



BRÜNINGS-LUCAS
 16 cm, 6 1/4"
 33627-04 4 mm
 33627-06 6 mm

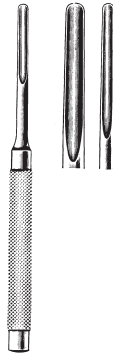

BRÜNINGS-LUCAS
 16 cm, 6 1/4"
 33628-03 3 mm
 33628-05 5 mm



STILLE
 20 cm, 8"
 33630-06 6 mm
 33630-08 8 mm
 33630-10 10 mm
 33630-12 12 mm
 33630-15 15 mm
 33630-20 20 mm
 33630-25 25 mm
 33630-30 30 mm



STILLE
 20 cm, 8"
 33631-10 6 mm
 33631-12 8 mm
 33631-15 10 mm
 33631-20 12 mm
 33631-25 15 mm
 33631-30 20 mm



STILLE
 20 cm, 8"
 33632-06 25 mm
 33632-08 30 mm
 33632-10 35 mm
 33632-12 40 mm
 33632-15 45 mm
 33632-20 50 mm
 33632-25 55 mm
 33632-30 60 mm



STILLE
 20 cm, 8"
 33633-06 6 mm
 33633-08 8 mm
 33633-10 10 mm
 33633-12 12 mm
 33633-15 15 mm
 33633-20 20 mm
 33633-25 25 mm
 33633-30 30 mm



STILLE
 20 cm, 8"
 33634-06 6 mm
 33634-08 8 mm
 33634-10 10 mm
 33634-12 12 mm
 33634-15 15 mm
 33634-20 20 mm
 33634-25 25 mm
 33634-30 30 mm

Osteotome, Hohlmeißel
Chisels, Gouges
Cinceles, Gubias
Scalpelli, scorbie

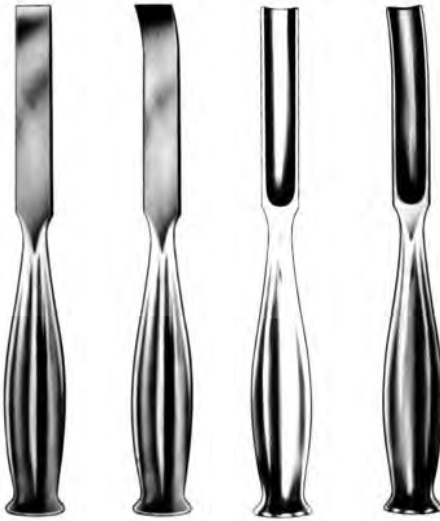

SMITH-PETERSEN
20 cm, 8"

6 mm	33644-06	33645-06	33647-06	
9 mm	33644-09	33645-09	33647-09	33649-09
13 mm	33644-13	33645-13		
14 mm			33647-14	33649-14
16 mm	33644-16	33645-16	33647-16	33649-16
19 mm	33644-19	33645-19	33647-19	33649-19
25 mm	33644-25	33645-25	33647-25	33649-25
32 mm	33644-32	33645-32	33647-32	33649-32

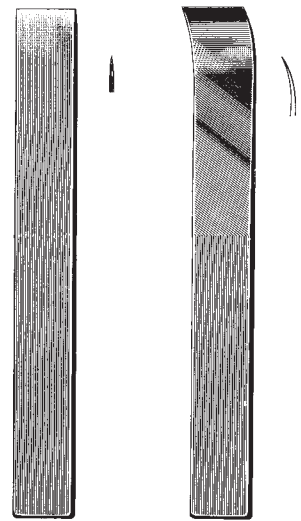

LAMBOTTE
24 cm, 9 1/2" 23 cm, 9"

33650-04	4 mm	33651-04
33650-06	6 mm	33651-06
33650-08	8 mm	33651-08
33650-10	10 mm	33651-10
33650-13	13 mm	33651-13
33650-16	16 mm	33651-16
33650-18	18 mm	33651-18
33650-20	20 mm	33651-20
33650-25	25 mm	33651-25
33650-30	30 mm	33651-30
33650-38	38 mm	33651-38
33650-44	44 mm	33651-44
33650-50	50 mm	33651-50

Osteotome, Hohlmeißel
 Chisels, Gouges
 Cinceles, Gubias
 Scalpelli, sgorbie



MINI-LAMBOTTE



2 mm



3 mm



4 mm



6 mm



8 mm



10 mm



12 mm



15 mm

12,5 cm, 5"	mm	17 cm, 6 3/4"
33654-02	2	33652-02
33654-03	3	33652-03
33654-04	4	33652-04
33654-06	6	33652-06
33654-08	8	33652-08
33654-10	10	33652-10
33654-12	12	33652-12
33654-15	15	33652-15

Hohlmeißel mit Ferrozellgriff
 Gouges with Ferrozell-Handle
 Gubias con mango de Ferrozell
 Sgorbie con manico di Ferrozell

8 mm



COBB
 28 cm, 11"
 33656-28

8 mm



COBB
 28 cm, 11"
 33657-28

8 mm



COBB
 28 cm, 11"
 33658-28

8 mm



COBB
 28 cm, 11"
 33659-28

Osteotome, Hohlmeißel mit Ferrozell-Griff
 Chisels and Gouges with Ferrozell-Handle
 Gubias con mango de Ferrozell
 Osteotomo, con manico di Ferrozell



LEXER
 22 cm, 8 3/4"

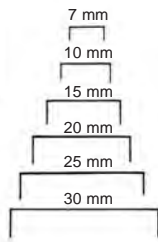

33660-07	7 mm	33661-07
33660-10	10 mm	33661-10
33660-15	15 mm	33661-15
33660-20	20 mm	33661-20
33660-25	25 mm	33661-25
33660-30	30 mm	33661-30

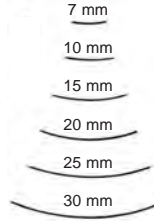

LEXER
 22 cm, 8 3/4"



LEXER MINI
 18 cm, 7"

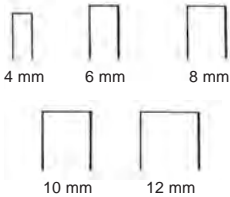

33664-04	4 mm	33665-04
33664-06	6 mm	33665-06
33664-08	8 mm	33665-08
33664-10	10 mm	33665-10
33664-12	12 mm	33665-12

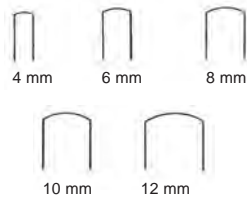

LEXER MINI
 18 cm, 7"

Flachmeißel, Hohlmeißel
 Chisels, Gouges
 Cinceles, Gubias
 Scalpelli, sgorbie



20 mm

33665-24
 24,5 cm, 9 3/4"



16 mm

33665-26
 26,5 cm, 10 1/2"



ZIELKE 23 cm, 9"
 33665-55 5,5 mm
 33665-90 9,0 mm



9 mm

22 cm, 8 3/4"
 33666-22

Hohlmeißel mit NOVOTEX-Griff
 Gouges with Novotex-Handle
 Gubias con mango de Novotex
 Sgorbie con manico di Novotex

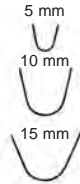

25 cm, 10"

33669-05	5 mm	33670-05
33669-10	10 mm	33670-10
33669-15	15 mm	33670-15

Flachmeißel, Hohlmeißel
Chisels, Gouges
Cinceles, Gubias
Scalpelli, Sgorbie



HOKE

14 cm, 5 1/2"

33668-03	3 mm
33668-05	5 mm
33668-06	6 mm
33668-08	8 mm
33668-09	9 mm
33668-13	13 mm
33668-16	16 mm
33668-19	19 mm



HIBBS

24 cm, 9 1/2"

33670-06	6 mm
33670-09	9 mm
33670-13	13 mm
33670-16	16 mm
33670-19	19 mm
33670-25	25 mm
33670-32	32 mm



HIBBS

24 cm, 9 1/2"

33671-06	6 mm
33671-09	9 mm
33671-13	13 mm
33671-16	16 mm
33671-19	19 mm
33671-25	25 mm
33671-32	32 mm



HIBBS

24 cm, 9 1/2"

33672-06	6 mm
33672-09	9 mm
33672-13	13 mm
33672-16	16 mm
33672-19	19 mm
33672-25	25 mm
33672-32	32 mm



HIBBS

24 cm, 9 1/2"

33673-06	6 mm
33673-09	9 mm
33673-13	13 mm
33673-16	16 mm
33673-19	19 mm
33673-25	25 mm
33673-32	32 mm



HIBBS

24 cm, 9 1/2"

33675-06	6 mm
33675-09	9 mm
33675-13	13 mm
33675-16	16 mm
33675-19	19 mm
33675-25	25 mm
33675-32	32 mm

Meißel
Chisels
Cinceles
Scalpelli



33676-02
9 cm, 3 1/2"
Spannschlüssel
Key
Llave
Clé
Chiave

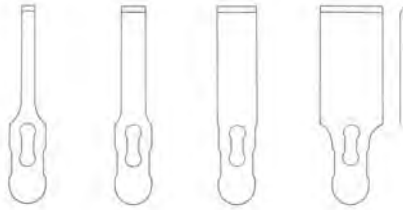

5 mm	10 mm	16 mm	25 mm
33676-05	33676-10	33676-16	33676-25
8,5 mm, 3.4"	8,5 mm, 3.4"	8,5 mm, 3.4"	8,5 mm, 3.4"

Meißelklingen
auswechselbar
Chisel blades
interchangeable
Hojas de cincel
intercambiables
Lame intercambiabili

33676-01
18,5 cm, 7 1/4"
Griff allein
Handle only
Mango suelto
Manico solo

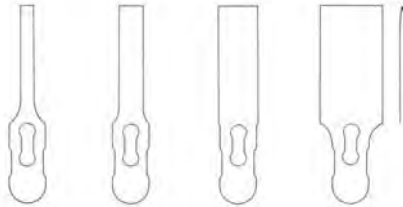

5 mm	10 mm	16 mm	25 mm
33677-05	33677-10	33677-16	33677-25
8,5 mm, 3.4"	8,5 mm, 3.4"	8,5 mm, 3.4"	8,5 mm, 3.4"

Osteotomklingen
auswechselbar
Osteotome blades
interchangeable
Hojas de osteótomo
intercambiables
Lame per osteotomia
intercambiabili

Schädelspalter, Rachiotom, Sternummeißel, Osteotom, Muskelhaken
 Skull breaker, Rachiotome, Sternum Chisel, Osteotome, Muscle hooks
 Cincel rompe-cráneo, Raquíotomos, Cinceles de esternón, Osteotomo, Ganchos musculare
 Divisore per cranio, Rachiotomi, Scalpello per sterno, Osteotomo, Uncino per muscoli



LEBSCHKE
 33678-24
 24,5 cm, 9 3/4"



33679-13
 13 cm, 5 1/8"



33680-22
 14 cm, 5 1/2"



33682-22
 22 cm, 8 3/4"



19902-10
 10 cm, 4"



19903-00

Meißel, Sektionsnadeln
 Chisels, Post mortem needles
 Cinceles, Agujas para autopsia
 Scalpelli, Aghi per autopsia



89146-20 20 cc
 110 x 20 mm

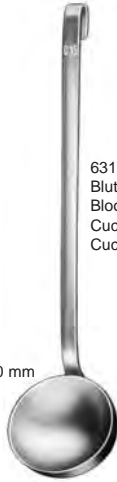

Ø 90 mm

63174-00
 Blutschöpfer, 150 ccm
 Blood scoop, 9 cu. inches
 Cucharra p / sangre
 Cucchiaino per sangue

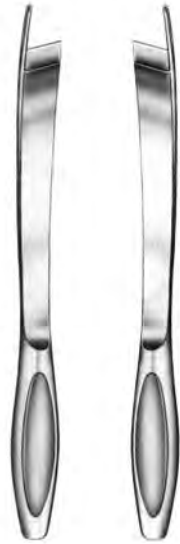

BRUNETTI
 28,5 cm, 11 1/4"

33682-01	33682-02
links	rechts
left	right
izquierdo	derecho
sinistra	destra

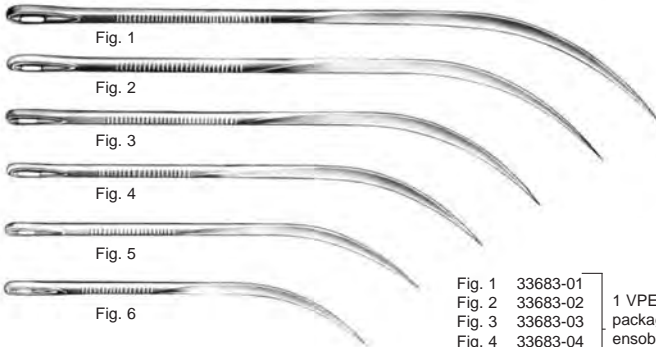

Fig. 1	33683-01	1 VPE = 12 Stk. package of 12 ensobres de 12 confezione di 12
Fig. 2	33683-02	
Fig. 3	33683-03	
Fig. 4	33683-04	
Fig. 5	33683-05	
Fig. 6	33683-06	

Obduktionsbesteck
Post Mortem Set
Estuches para Autopsia
Astucci per Autopsia



33684-00

Kleines Besteck, Holzetui, enthaltend:

- 4 Skalpelle
- 1 Knorpelmesser
- 1 Inzisionsschere, 13 cm (5 1/8")
- 1 Anatomische Pinzette, 13 cm (5 1/8")
- 1 Amputationssäge Charrière
- 1 Hammer
- 1 Meißel
- 2 doppelte Muskelhaken
- 2 doppelte Tubuli
- 2 Knopfsonden, 13 cm (5 1/8")
- 3 Wundnadeln

Small set, wooden case, containing:

- 4 Dissecting Knives
- 1 Cartilage Knife
- 1 Incision Scissors, 13 cm (5 1/8")
- 1 Dissecting Forceps, 13 cm (5 1/8")
- 1 Amputation Saw Charrière
- 1 Mallet
- 1 Chisel
- 2 Retractors, double ended
- 2 Blow pipes, double
- 2 Probes, 13 cm (5 1/8")
- 3 Suture Needles

Modelo pequeño, estuche de madera, conteniendo:

- 4 Escalpelos
- 1 Cuchillo para cartilago
- 1 Tijera de incision, 13 cm (5 1/8")
- 1 Pinza para disección, 13 cm (5 1/8")
- 1 Sierra de amputación Charrière
- 1 Martillo
- 1 Escoplo
- 2 Separadores de 2 garfios, dobles
- 2 Tubos insufladores, dobles
- 2 Estiletos olivares, 13 cm (5 1/8")
- 3 Agujas para sutura

Modelo piccolo, astuccio di legno, composto da:

- 4 Bisturi
- 1 Coltello per cartilagine
- 1 Forbice per incisione, 13 cm (5 1/8")
- 1 Pinza anatomica, 13 cm (5 1/8")
- 1 Sega per amputazione, Charrière
- 1 Martello
- 1 Scalpello
- 2 Divaricatori con 2 ganci, doppi
- 2 Tubi inalatori, doppi
- 2 Specilli bottonuti, doppi, 13 cm (5 1/8")
- 3 Aghi per sutura

Hämmer
 Bone Hammers and Mallets
 Martillos y mazos
 Martelli



GERZOG
 18 cm, 7"
 33686-25 250 g

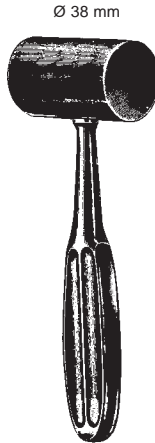

KIRK
 19 cm, 7 1/2"
 33687-75 750 g

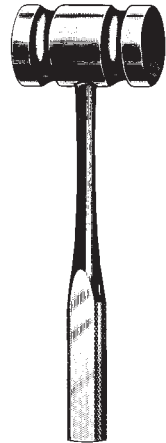

26,5 cm, 10 1/2"
 33688-45 450 g
 33689-90 900 g

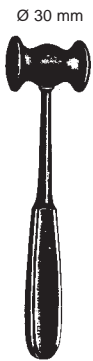

COLLIN
 20 cm, 8"
 33690-22 220 g



33699-00
 23,5 cm, 9 1/4"
 480 g



135 g
 33694-01 18,5 cm, 7 1/4"
 33694-03 Ersatzbacken
 Nylon Caps
 Tapas de repuesto
 Placche di ricambio

Hämmer
Bone Hammers and Mallets
Martillos y mazos
Martelli



WILLIGER
24 cm, 9 1/2"
33691-34 340 g



Ø 25 mm
LUCAE
19 cm, 7 1/2"
33692-26 260 g

massiv, mit auswechselbaren Ferrozellbacken
solid, with interchangeable Ferrozell jaws
macizo, con tapas intercambiables de Ferrozell
solido, con placche intercambiabili in Ferrozell



Ø 20 mm
33693-33
Paar Ersatzbacken
Pair spare jaws
par de tapas de repuesto
Coppia di placche di ricambio
33693-34
Satz Ringe
Set rings
juego de anillos
Set anelli
33693-32 320 g

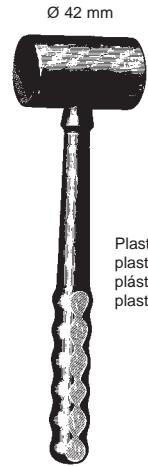

Ø 42 mm
26 cm, 10 1/2"
33695-40 400 g
Plastik
plastic
plástico
plastica



QUISLING
33696-75



Ø 22 mm
PARTSCH
33698-98
18 cm, 7"
199 g



33699-17
26,5 cm, 10 1/2"
530 g

Hämmer
 Bone Hammers and Mallets
 Martillos y mazos
 Martelli



Ø 30 mm

33700-01-01
 Ersatzbacken
 Nylon Caps
 Tapas de repuesto
 Placche di ricambio

24,5 cm, 9 3/4" 215 g
 33700-01

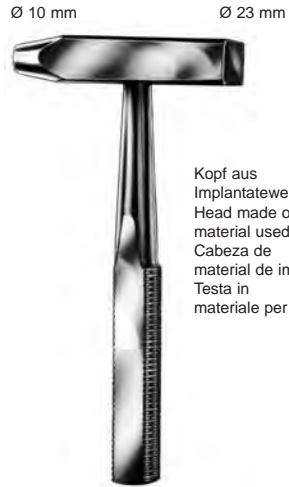

Ø 10 mm

Ø 23 mm

Kopf aus
 Implantatwerkstoff
 Head made of
 material used for implants
 Cabeza de
 material de implantación
 Testa in
 materiale per impianti

23 cm, 9" 350 g
 33700-02



Ø 45 mm

BERGMANN
 24 cm, 9 1/2" 300 g
 33700-03



Ø 30 mm

BERGMANN
 23 cm, 9" 300 g
 33700-04

Hämmer
Bone Hammers and Mallets
Martillos y mazos
Martelli

Ø 30 mm



COTTLE
18 cm, 7" 240 g
33700-05

Ø 40 mm



HEATH
18 cm, 7" 700 g
33700-06

Ø 40 mm



OMBREDANNE
25 cm, 10" 700 g
33700-07

Ø 27 mm



HAJEK
21 cm, 8 1/2" 140 g
33700-08

Raspatorien
 Periosteal Elevators
 Periostótomos
 Periostotomi

12,5 mm



FARABEUF
 33702-15
 15 cm, 5.9"

12,5 mm



FARABEUF
 33703-15
 15 cm, 5.9"

11 mm



FARABEUF-COLLIN
 33704-01
 15,5 cm, 6"

11 mm

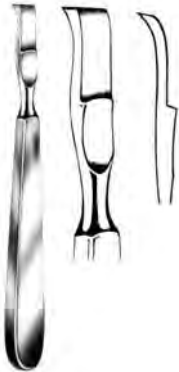

FARABEUF-COLLIN
 33704-02
 15,5 cm, 6"



LAMBOTTE
 21 cm, 8 1/4"
 33705-05 5 mm
 33705-10 10 mm
 33705-15 15 mm
 33705-20 20 mm
 33705-25 25 mm

18 mm



SEDILLOT
 18 cm, 7"
 33706-18

Raspatorien
 Periosteal Elevators
 Periostótomos
 Periostotomi



SEBILLEAU
 17,5 cm, 7"
 33707-17



QUERVAIN
 19,5 cm, 7 3/4"
 33708-19

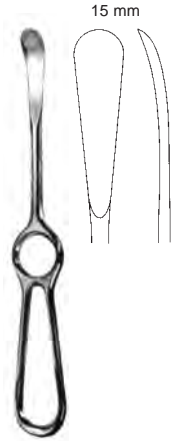

SEDILLOT
 21 cm, 8 1/4"
 33709-21



LANGENBECK
 19 cm, 7 1/2"
 33710-19



LANGENBECK
 18 cm, 7"
 33711-18



LANGENBECK
 20 cm, 8"
 33711-20 8 mm
 33711-21 10 mm

Raspatorien, Elevatoren
 Raspatories, Elevators
 Periostótomos, Elevadores
 Periostotomi, Elevatori

4 mm



WILLIGER
 33711-16
 16 cm, 6 1/4"

6,5 mm



WILLIGER
 33712-16
 16 cm, 6 1/4"

5 mm



WILLIGER
 33713-16
 16 cm, 6 1/4"

5,5 mm



WILLIGER
 33713-17
 17 cm, 6 3/4"

5 mm

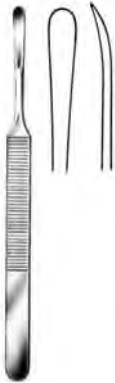

KÖNIG
 33714-15
 15,5 cm, 6"

12 mm

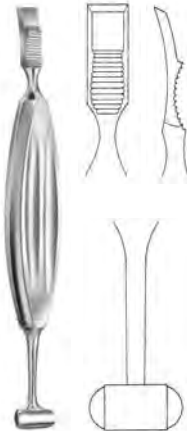

ALEXANDER
 33715-20
 21 cm, 8 1/4"



MOLT
 33716-18
 18 cm, 7"

Raspatorien, Elevatoren
 Raspatories, Elevators
 Periostótomos, Elevadores
 Periostotomi, Elevatori

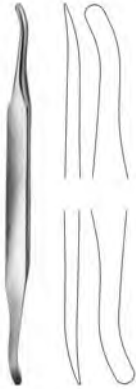

SELDIN
 33717-19-01
 19,5 cm 7 3/4"

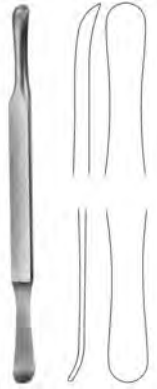

SELDIN
 33717-19-02
 19,5 cm 7 3/4"



JOSEPH
 33718-16
 16 cm, 6 1/4"



FOMON
 33719-17
 17 cm, 6 3/4"



BOIES
 33720-19
 19 cm, 7 1/2"



GORNEY
 33720-21
 21 cm, 8 1/2"

Raspatorien, Elevatoren
 Periosteal Elevators
 Periostótomos, Elevadores
 Periostotomi, Elevatori

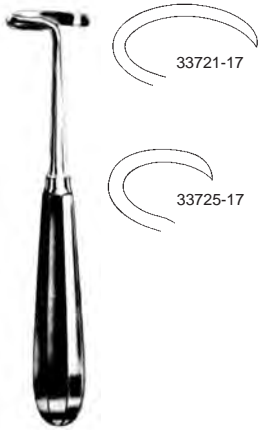

DOYEN
 17 cm, 6 3/4"

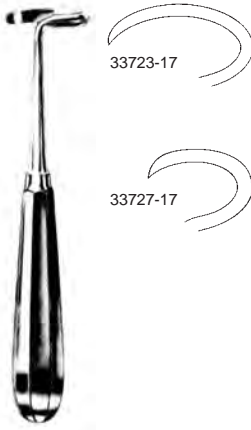

DOYEN
 17 cm, 6 3/4"



DOYEN
 33728-24 33729-24
 24 cm 9 1/2"



SEMB

12 mm



33729-01
 17,5 cm
 7"

12 mm



33729-02
 21 cm
 8 1/4"

12 mm



33729-03
 17,5 cm
 7"

13 mm



33729-04
 21 cm
 8 1/4"

15 mm



33729-05
 20,5 cm
 8"

15 mm



33729-06
 20,5 cm
 8"



33729-07
 22,5 cm
 8.9"

Elevatoren, Raspatoren
Elevators, Raspatories
Elevadores, Periostótomos
Elevatori, Periostotomi



MATSON-ALEXANDER
33731-22
22 cm, 8 3/4"



MATSON
33733-22
22 cm, 8 3/4"



33740-19
19 cm, 7 1/2"



33741-18
18,5 cm, 7 1/4"



33742-18
18,5 cm, 7 1/4"



33743-18
18,5 cm, 7 1/4"

Elevatoren, Raspatoren
 Elevators, Raspatories
 Elevadores, Periostótomos
 Elevatori, Periostotomi

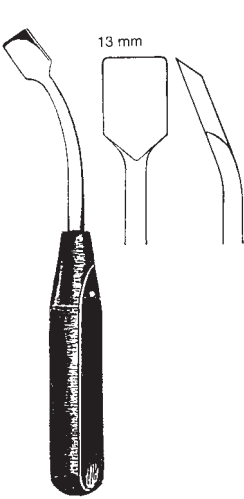

33745-19
 18,5 cm, 7 1/2"

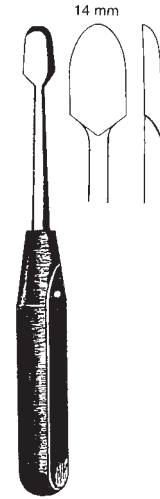

33746-19
 19,5 cm, 7 3/4"

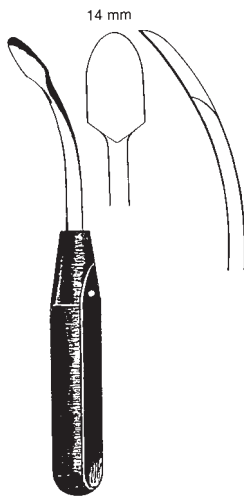

33747-18
 18,5 cm, 7 1/4"

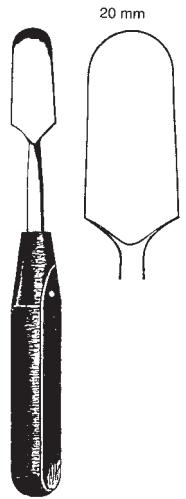

33748-20
 20 cm, 8"

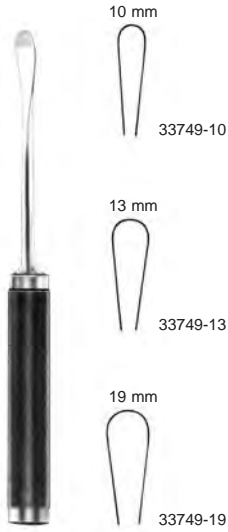

COBB
 28 cm, 11"



COBB
 27 cm, 10 1/2"

Elevatoren
Elevators
Elevadores
Elevatori

scharf
sharp
cortante
tagliente



SAYRE
17 cm, 6 $\frac{3}{4}$ "
33758-01

stumpf
blunt
romo
smusso



SAYRE
17 cm, 6 $\frac{3}{4}$ "
33758-02

Elevatoren, Knochenhebel
 Elevators, Bone Levers
 Elevadores para huesos
 Elevatori, Elevatori per ossa

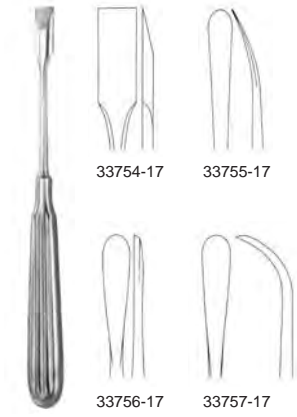

ADSON
 17 cm, 6 3/4"

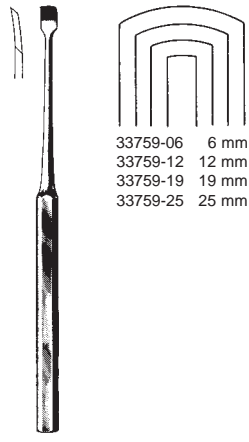

KEY
 33759-06 - 33759-25
 19 cm, 7 1/2"



CHANDLER
 33763-01 19,0 cm 7 1/2"
 33763-02 20,3 cm 8"
 33763-03 22,9 cm 9"
 33763-04 25,4 cm 10"

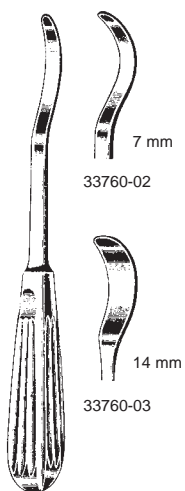

CREGO
 33760-01
 20 cm, 8"



ALDERDYCE
 33761-21
 21 cm, 8 1/2"

Elevatoren, Knochenhebel
 Elevators, Bone Levers
 Elevadores para huesos
 Elevatori, Elevatori per ossa

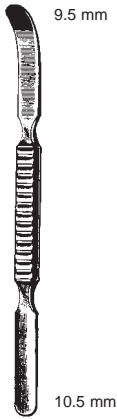

WATSON-CHEYNE
 33765-17
 17,5 cm, 7"



MC DONALD
 33767-19
 19 cm, 7 1/2"



MURPHY-LANE
 33769-30
 30 cm, 11 1/4"



BENNETT
 33771-71
 65x260 mm



BENNETT
 33771-73
 45x260 mm

Knochenhebel
 Bone Levers
 Elevadores para huesos
 Elevatori per ossa

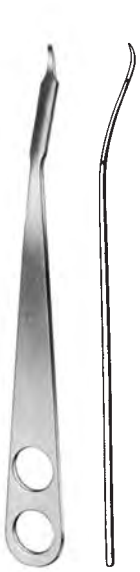

HOHMANN
 33801-08 8 mm
 33801-12 12 mm

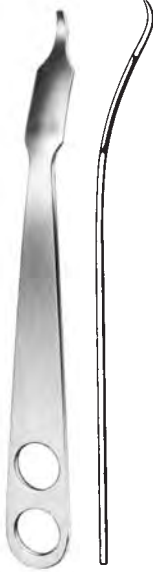

HOHMANN
 33801-18
 18 mm, 3/4"

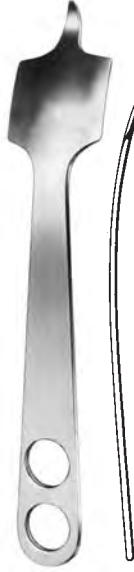

HOHMANN
 33801-43
 43 mm, 1 1/2"



HOHMANN
 33801-70
 70 mm, 2 1/4"



4,5 mm

KÖNIG
 33802-01
 15 cm, 6"



4,5 mm

KÖNIG
 33802-02
 15 cm, 6"



2,8 mm

33802-14
 14 cm, 5 1/2"



5 mm

33803-05
 15 cm, 6"

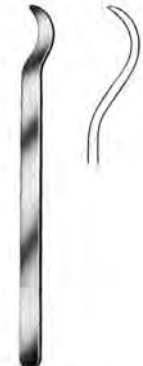

7 mm

33803-07
 15 cm, 6"

Knochenheber
 Bone Levers
 Elevadores para huesos
 Elevatori per ossa



HOHMANN
 33803-43 43 mm

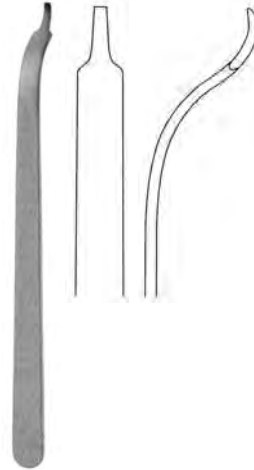

BUCK-GRAMCKO
 33804-15 15 mm



HOHMANN
 33805-22 22 mm



HOHMANN
 33805-33 33 mm



HOHMANN
 33807-24 24 mm



HOHMANN
 33809-22 22 mm

Knochenhebel
Bone Levers
Elevadores para huesos
Elevatori per ossa

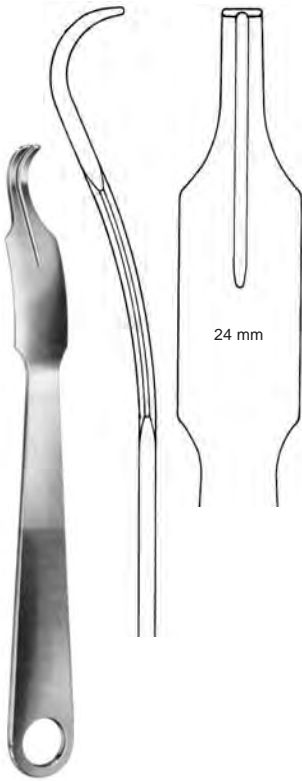

LANGE-HOHMANN
33810-24
25 cm, 10"



HOHMANN mini
16 cm, 6 1/4"

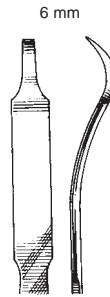

33811-06

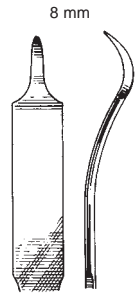

33811-08

Knochenhebel
Bone Levers
Elevadores para huesos
Elevatori per ossa

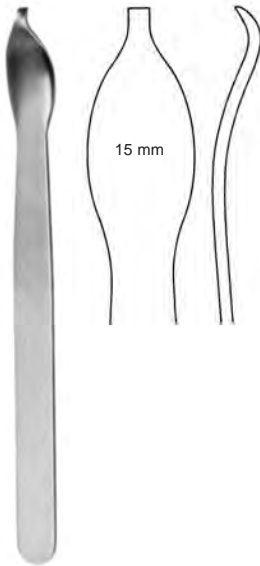

33812-16
16 cm, 6 1/4"

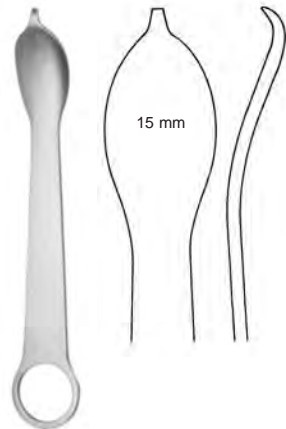

33813-12
12 cm, 4 3/4"

Knochenhebel
 Bone Levers
 Elevadores para huesos
 Elevatori per ossa

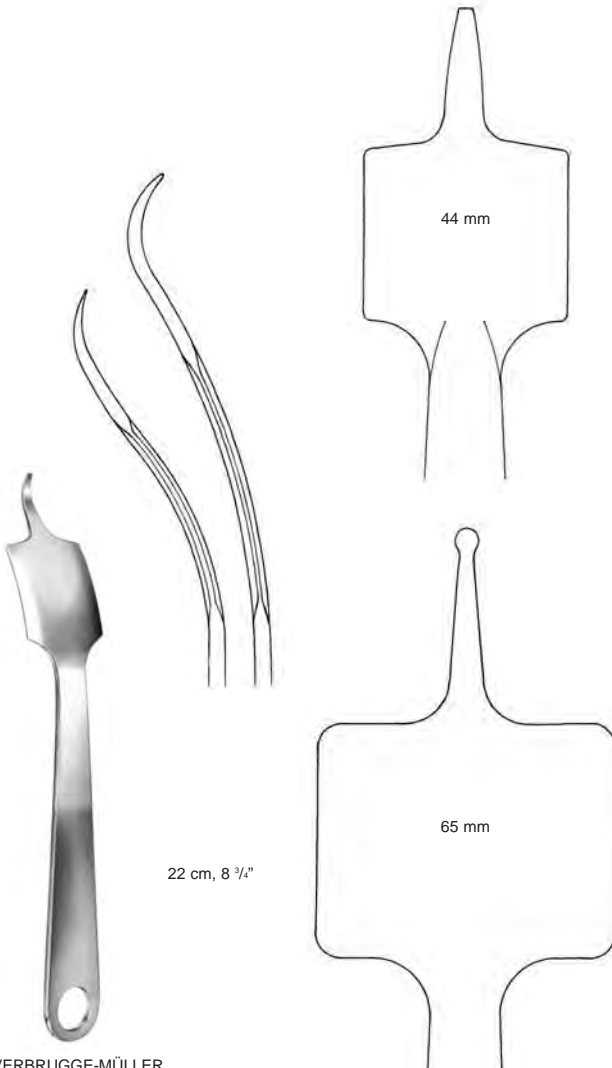

VERBRUGGE-MÜLLER
 33814-44 24,0 cm, 9 1/2"
 33814-65 25,5 cm, 10"

Knochenhebel
Bone Levers
Elevadores para huesos
Elevatori per ossa



BLOUNT
33823-26
26 cm, 10 1/4"

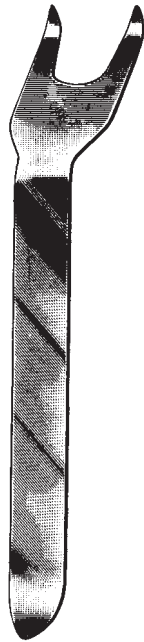

BLOUNT
33825-26
26 cm, 10 1/4"

Bauchdeckenhalter, Knochenheber, Meniskushaken
 Abdominal Retractor, Bone Levers, Meniscus Retractors
 Separador abdominal, Elevadores p. huesos, Separadores para menisco
 Divaricatori abdominali, Elevatori per ossa, Divaricatori per il menisco

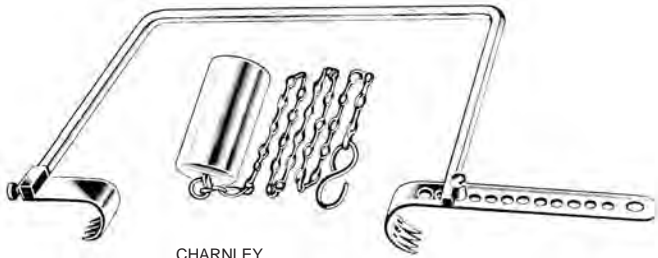

CHARNLEY
33826-00

33826-01 spitz, gerieft
 pointed tip, serrated
 punta aguda, dentada
 punta acuta, zigrinata

33826-02 stumpf, gerieft
 blunt tip, serrated
 punta roma, dentada
 punta smussa, zigrinata

33826-03 stumpf, glatt
 blunt tip, smooth
 punta roma, lisa
 punta smussa, liscia



AUFRANC-COBRA
26 cm 10 1/4"



BLOUNT
33827-17
17,5 cm 7"

Knochenhebel
 Bone Levers
 Elevadores p. huesos
 Elevatori per ossa



LANE TRETOWAN
 33828-21
 21,5 cm 8 1/2"



LANE
 33829-25
 25,5 cm 10"



BRISTOW
 33830-23
 23 cm 9"

Knochenheber, Meniskushaken
 Bone Levers, Meniscus Retractors
 Elevadores p. huesos, Separadores para menisco
 Elevatori per ossa, Divaricatori per il menisco

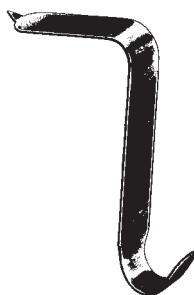

TAYLOR
 16,5 cm, 6 1/2"
 33831-16 75x30 mm
 33833-16 100x30 mm



12 x 13 mm
 33832-01



52 x 13 mm
 33832-02

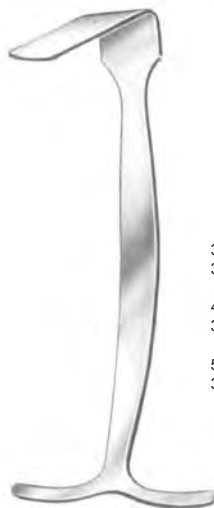

SMILLIE
 14 cm, 5 1/2"

32 x 19 mm
 33832-03

48 x 19 mm
 33832-04

57 x 19 mm
 33832-05

Sehenschäler, Sehnenfaßpinzette, Sehnenhaltezange, Sehnenfaßinstrumente
 Tendon seizing instruments
 Instrumentos para coger tendones
 Enucleatore di tendine, Strumenti per afferrare tendini



SMILLIE
 33910-17
 17 cm, 6 3/4"

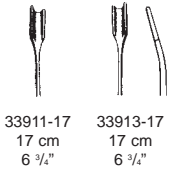

33911-17
 17 cm
 6 3/4"

33913-17
 17 cm
 6 3/4"

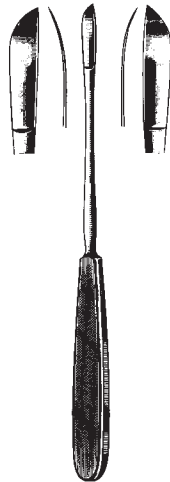

NEFF
 33921-22 - 33923-22
 22 cm, 8 3/4"



33950-01 3 mm

33950-02 4 mm

33950-03 5 mm

33950-04 6 mm

33950-05 7 mm

BUNELL
 33950-01 - 33950-05
 15 cm, 6"



LARSEN
 33960-15 - 33960-55
 10 cm, 4"

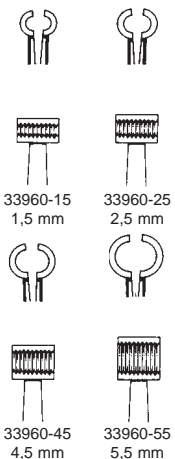

33960-15
 1,5 mm

33960-25
 2,5 mm

33960-45
 4,5 mm

33960-55
 5,5 mm



JACKSON
 33961-15
 15 cm, 6"

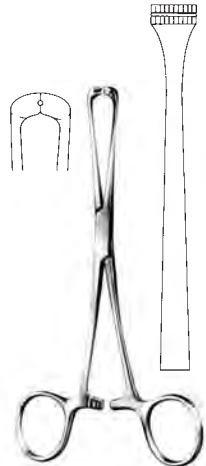

STEINMANN
 33962-16
 16 cm, 6 1/4"

Sehnenfaßinstrumente, Sehnenführer
 Tendon seizing instruments, Tendon passing instr.
 Instrumentos para coger tendones, Instrumento p. el tunel del tendon
 Strumenti per afferrare tendini



33963-12
 12 cm, 4 3/4"



BRAND
 33964-15 - 33964-24



33964-15
 15 cm, 6"



33964-19
 19 cm, 7 1/2"



33964-24
 24 cm, 9 1/2"



BRAND
 33965-15 15 cm, 6"
 33965-19 19 cm, 7 1/2"
 33965-24 24 cm, 9 1/2"



CAROLL
 33966-11
 11 cm, 4 3/8"

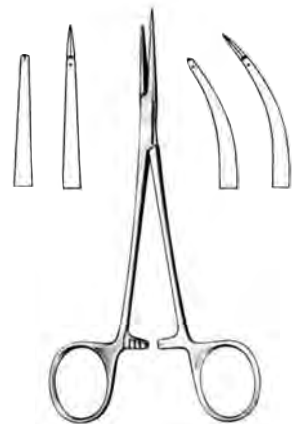

33966-15 15 cm, 6" 33967-15

Sehnenfassinstrumente, Sehnenstripper, Knochenfeilen, Raspeln
 Tendon seizing instruments, Tendon Strippers, Bone Files, Rasps
 Instrumentos para coger tendones, Enucleadores de tendones, Limas, Escofinas
 Strumenti per afferrare tendini, Scollatendini, Lime per ossa, Raspe

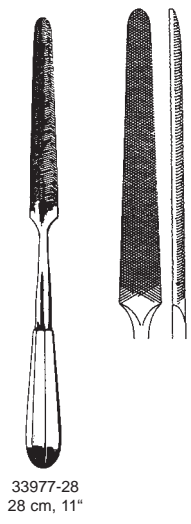
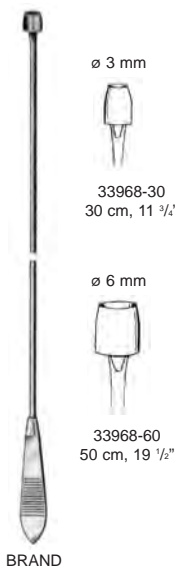

Komprimeter
Pneumatic Tourniquet
Torniquete pneumático
Apparecchio di compressione



34101-01
compl.

Gerät zur Erzeugung von Bluteere in den Gliedmaßen
Compression Apparatus for producing blood vacuum in limbs
Aparato de compresión para producir el vacío de sangre en los miembros
Vacumentro per determinare vuoti di sangue nelle membra

34101-02
Pumpe
Air Pump
Bomba de aire
Pompa di aria

34101-03
Manometer
Manometer
Manómetro
Manometro

34101-04
Oberarmmanschette
Cuff for upper arm
Brazalete (brazo)
Bracciale
34101-06 incl.

34101-05
Oberschenkelmanschette
Cuff (leg)
Brazalete (pierna)
Cosciale
34101-07 incl.

34101-06
Polster für Oberarmmanschette 46 x 6 cm (18" x 2.4")
Bandage cuff for arm 46 x 6 cm (18" x 2.4")
Brazalete para brazo 46 x 6 cm (18" x 2.4")
Bracciale per braccio superiore 46 x 6 cm (18" x 2.4")

34101-07
Polster für Oberschenkelmanschette 55 x 10 cm (21 1/2 x 10")
Bandage cuff for leg 55 x 10 cm (21 1/2 x 10")
Brazalete para el fémur 55 x 10 cm (21 1/2 x 10")
Bracciale per coscia superiore 55 x 10 cm (21 1/2 x 10")

Amputations- und Resektionssägen
 Amputation and Resection Saws
 Sierras para amputación y resección
 Seghe per amputazione e resezione

Staubinde
 Compression bandage
 Vendaje de compresión
 Benda per compressione
 5 m lang / long
 6 cm breit / wide



ESMARCH
 34105-01

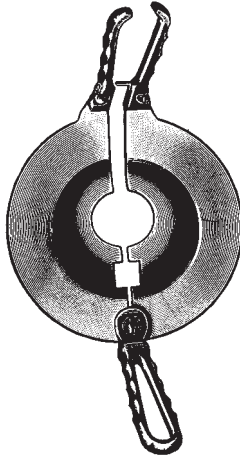

PERCY
 34110-00



CHARRIERE
 34112-00

34112-01
 12 mm

Ersatzsägeblätter
 Spare saw blades
 Hojas de sierra de
 repuesto
 Lame di ricambio

34112-02
 15 mm

Ersatzsägeblätter
 Spare saw blades
 Hojas de sierra de
 repuesto
 Lame di ricambio

komplett mit 2 Blättern
 complete with 2 blades
 completo con 2 hojas
 completa con 2 lame



mit 3 Sägeblätter
 4 - 6 - 8 mm
 con 3 hojas de repuesto
 with 3 spare blade
 con 3 lame di ricambio

BIER
 34114-39
 40,5 cm, 16"



CHARRIERE
 34116-30
 30 cm, 11 3/4"

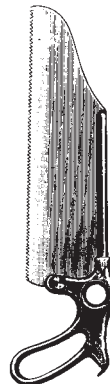

SATTERLEE
 34118-31
 31 cm, 12 1/4"



LANGENBECK
 34120-23
 23 cm, 9"

Nagelausreißzange, Fingerringsägen
 Fcps. f. tearing out finger nails, Finger Ring Saws
 Pinzas para arrancar uñas, Sierras para abrir anillos
 Pinze per lacerazione delle unghie, Seghe per anelli

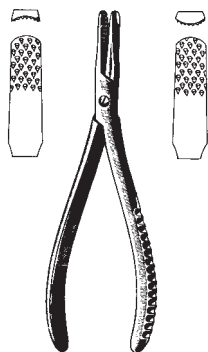

RADOLF

34161-13 13,5 cm, 5 1/4" 3 mm
 34162-13 13,5 cm, 5 1/4" 6 mm

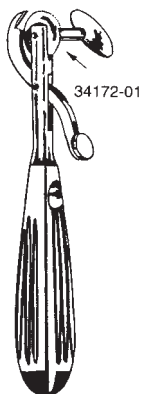

WALTON
 34172-00

Sägeblatt
 Saw blade
 Hoja de sierra
 Lama di ricambio



REDA
 34175-00

Sägeblatt
 Saw blade
 Hoja de sierra
 Lama di ricambio

Bohrapparate
 Bone Hand Drills
 Perforador de mano
 Perforatori a mano

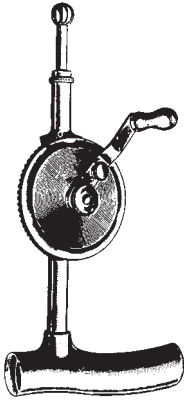

STILLE
 34210-20 20 cm, 8"
 compl. incl. 34212-25 - 34214-16

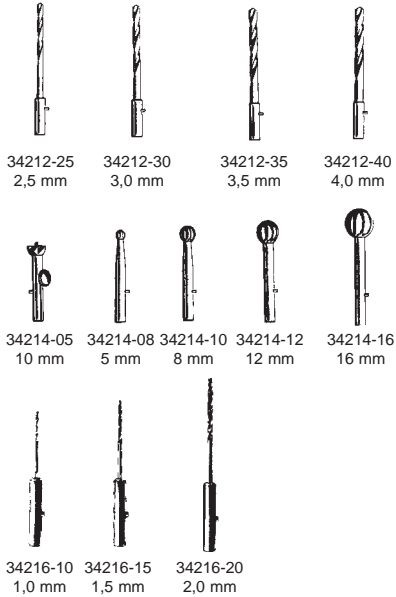

STILLE-SHERMAN
 34220-24 24 cm, 9 1/2"
 compl. incl. 34222-25 - 34222-35



MOORE
 34230-28 28 cm, 11"
 compl. incl. 34232-00

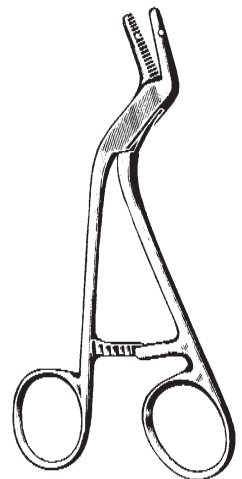

ADSON
 34231-15
 15 cm, 6"

Bohrapparate
Bone Hand Drills
Perforador de mano
Perforatori a mano



34241-00
Griff allein
Handle only
Mango solo
Manico solo

HUDSON

34240-27 27 cm, 10 1/2"
compl. incl. 34242-09, -14, -16, -22,
34246-00



34242-09
9 mm



34242-14
14 mm



34242-16
16 mm



34242-22
22 mm



ø 2 mm
34243-02



CUSHING
34244-10
34244-14
34244-16



ERRICO
34244-17
ø 16 mm



MC KENZIE
34248-00
ø 13 mm



34246-00
Verlängerungsstück
Extension piece
Pieza alargadera
Giunto di prolungamento



KIRSCHNER
34250-00 compl.



34252-00



BUNELL
34270-00 16 cm, 6 1/4"

34270-01
Schlüssel
Wrench
Llave
Chiave

Bohrapparat 16 cm (6 1/4"), längsdurchbohrt mit Dreibackenspannfutter und Schlüssel, Spannweite bis 4 mm

Hand drill, 16 cm (6 1/4"), longitudinally bored, with three-jaw-chuck and key, opening up to 4 mm

Perforador manual, 16 cm (6 1/4"), taladrado longitudinalmente, con mandrill de tres mordazas y llave, abriendo hasta 4 mm

Perforatore a mano, 16 cm (6 1/4"), con perforazione assiale, con mandrino a tre ganasce e chiave, apertura fino a 4 mm di D.

Bohrapparate, Handgriffe
 Bone Hand Drills, Handles
 Perforador de mano
 Perforatori a mano, manici



RALK
34280-00



REDA
34290-00



34295-00



34296-00

Spannschlüssel allein
 Key only
 Llave suelta
 Chiave solo

Handgriff mit Jacobs-
 spannfutter und
 Spannschlüssel
 Handle with Jacobs chuck
 and key
 Mango con cierre Jacobs,
 de 3 mordazas y llave
 Manico con mandrino di
 Jacobs e chiave

Bohrapparat mit Leichtmetallgehäuse, mit Dreibackenspannfutter und Schlüssel, Spannweite bis D. 6,35 mm
 Hand drill with light metal case, with three-jaw-chuck and key, opening up to D. 6,35 mm
 Perforador manual con caja de aluminio, con mandril de tres mordazas y llave, abriendo hasta 6,35 mm de D.
 Perforatore a mano con cassa in metallo leggero, con mandrino a tre ganasce e chiave, apertura fino a 6,35 mm di D.

Handbohrapparat mit umstellbarem Handgriff, mit Jacobs Dreibackenspannfutter und Schlüssel
 Hand drill with adjustable handle, with Jacobs three-jaw-chuck and wrench
 Perforador de mano en T con cierre Jacobs de 3 mordazas y llave de ajuste
 Perforatore a mano con manico regolabile, con mandrino a tre ganasce di Jacobs e chiave



34296-05

T-Handgriff, verriegelbares schlüsselloses Dreibackenspannfutter, rostfrei
 T-handle, keyless locking chuck
 Mango en T, mordaza sin llave, inox.
 Chiave a T con mandrino a tre ganasce inox



34296-10

Handgriff, Dreibackenspannfutter, inkl. Spannschlüssel rostfrei
 Handle with chuck, including key
 Mango, mordaza incluyendo llave, inox.
 Mandrino a tre ganasce con manico retto completo di chiave di arresto inox



34296-15

"Hudson" T-Handgriff, Schnellkupplung
 Hudson T-handle with fast gripping chuck
 Mango en T, acople rápido
 Hudson: mandrino con manico a T
 Ganasce con raccordo rapido



34296-20

Schnellkupplungs T-Handgriff, groß
 T-handle with fast gripping chuck, large
 Mango en T, acople rápido, grande
 Mandrino a T manico grande
 Raccordo rapido

Schnellkupplungs-Handgriffe, Bohrapparat elektr.
 Handles with quick action chuck, Bone drill electr.
 Perforador electrico y mangos de acople rápido
 Manici con attachi rapidi, Perforatori elettr.



34296-25
 Schnellkupplungs-T-Handgriff
 T-Handle, quick-action
 Mango en T, acople rápido
 Mandrino a T con raccordo rapido



34296-30
 Schnellkupplungs-Handgriff
 groß mit Hartgewebegriff
 Handle, quick-action, large,
 handle made of very hard fibre
 Mango de acople rápido,
 grande, de material extraduro
 Mandrino grande rapido con
 manico a fibre dure



34296-35
 Schnellkupplungs-Handgriff
 mit Hartgewebegriff
 Handle, quick-action,
 made of very hard fibre
 Mango de acople rápido,
 de material extra-duro
 Mandrino medio rapido con
 manico a fibre dure



34296-40
 Mini Schnellkupplungs-Handgriff
 für „Dental“-Anschluß
 Mini-Handle, quick-action,
 "dental"
 Mini-Mango de acople rápido
 "dental"
 Mini mandrino-rapido con
 impugnatura cilindrica con
 attacco dentale

Bohrer
Drill bits
Taladros
Perforatore



Ø			
1,0 mm	56 mm	34320-10	
1,5 mm	70 mm	34320-15	
2,0 mm	85 mm	34320-20	
2,5 mm	95 mm	34320-25	
2,7 mm	100 mm	34320-27	
3,0 mm	100 mm	34320-30	
3,2 mm	106 mm	34320-32	
3,5 mm	112 mm	34320-35	
4,0 mm	119 mm	34320-40	
4,5 mm	126 mm	34320-45	
5,0 mm	132 mm	34320-50	
6,0 mm	139 mm	34320-60	
7,0 mm	156 mm	34320-70	

Spiralbohrer mit Glattschaft
Twist Drills with round end
Taladros espirales con vástago redondo
Perforatore elicoidale



Ø			
1,0 mm	180 mm	34321-10	
1,5 mm	180 mm	34321-15	
2,0 mm	180 mm	34321-20	
2,5 mm	180 mm	34321-25	
2,7 mm	180 mm	34321-27	
3,0 mm	180 mm	34321-30	
3,2 mm	180 mm	34321-32	
3,5 mm	180 mm	34321-35	
4,0 mm	180 mm	34321-40	
4,5 mm	180 mm	34321-45	
5,0 mm	180 mm	34321-50	
6,0 mm	180 mm	34321-60	
6,5 mm	180 mm	34321-65	
7,0 mm	180 mm	34321-70	
8,0 mm	180 mm	34321-80	
9,0 mm	180 mm	34321-90	
10,0 mm	180 mm	34322-00	

Spiralbohrer mit Glattschaft langes Modell
Twist Drills, long typ
Taladros espirales, largos
Perforatore elicoidale, modello lungo



Ø			
1,1 mm	60 mm	34322-11	
1,5 mm	85 mm	34322-15	
2,0 mm	100 mm	34322-20	
2,5 mm	110 mm	34322-25	
2,7 mm	100 mm	34322-27	
3,2 mm	145 mm	34322-32	
3,5 mm	110 mm	34322-35	
4,5 mm	145 mm	34322-45	

Spiralbohrer mit Schnellkupplungs-Ansatz
Twist Drills, quick-action
Taladros espirales, acople rápido
Perforatore elicoidale con attacco rapido

Pfrieme, Reibahle
Awl, Reamer
Escariadores
Lesine, Punteruoli



34392-14
14 cm, 5 1/2"



PERTHES
34393-18
18 cm, 7"



PERTHES
34393-21
21 cm, 8 1/4"



34394-14
14 cm, 5 1/2"

Faßpinzette, Bohrdrahtspender
 Grasping forceps, Support for sterilisation
 Pinzas para coger, Soporte de esterilización
 Pinze per afferrare, Supporto per la sterilizzazione



34439-00

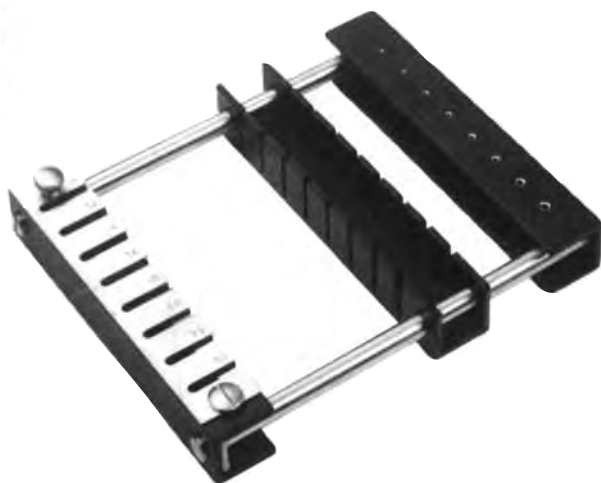

Bohrdrahtspender für Kirschner-Drähte
 Support for sterilisation of Kirschner wires
 Soporte de esterilización p. alambres de Kirschner
 Supporto per la sterilizzazione dei fili di Kirschner

34440-01 bis 15 cm – up to 15 cm (6") – hasta 15 cm – fino a 15 cm
 34440-02 bis 31 cm – up to 31 cm (12 1/4") – hasta 31 cm – fino a 31 cm
 34440-03 bis 10 cm – up to 10 cm (4") – hasta 10 cm – fino a 10 cm

Bohrdrähte
Drill Wires
Alambres
Perforatori filiformi

lieferbar in Packungen à 10 Stück
available in packages of 10 pieces
disponible en paquets de 10 unidades
disponibili solo in confezioni da 10 pezzi

Trokarspitze / Trocar point
Punta trocar / Punte trequarti

Ø	10 cm, 4"	15 cm, 6"	31 cm, 12 1/4"
0,8	34401-08	34402-08	34403-08
1,0	34401-10	34402-10	34403-10
1,1	34401-11	34402-11	34403-11
1,2	34401-12	34402-12	34403-12
1,3	34401-13	34402-13	34403-13
1,4	34401-14	34402-14	34403-14
1,5	34401-15	34402-15	34403-15
1,6	34401-16	34402-16	34403-16
1,7	34401-17	34402-17	34403-17
1,8	34401-18	34402-18	34403-18
1,9	34401-19	34402-19	34403-19
2,0	34401-20	34402-20	34403-20
2,2	34401-22	34402-22	34403-22
2,3	34401-23	34402-23	34403-23
2,4	34401-24	34402-24	34403-24
2,5	34401-25	34402-25	34403-25
2,8	34401-28	34402-28	34403-28
3,0	34401-30	34402-30	34403-30

Kirschner
mit rundem Ende / with round shaft
con extremo redondo / con extremo rotondo

Trokarspitze / Trocar point
Punta trocar / Punte trequarti

Ø	10 cm, 4"	15 cm, 6"	31 cm, 12 1/4"
0,8	34404-08	34405-08	34406-08
0,9	34404-09	34405-09	34406-09
1,0	34404-10	34405-10	34406-10
1,1	34404-11	34405-11	34406-11
1,2	34404-12	34405-12	34406-12
1,3	34404-13	34405-13	34406-13
1,4	34404-14	34405-14	34406-14
1,5	34404-15	34405-15	34406-15
1,6	34404-16	34405-16	34406-16
1,7	34404-17	34405-17	34406-17
1,8	34404-18	34405-18	34406-18
1,9	34404-19	34405-19	34406-19
2,0	34404-20	34405-20	34406-20
2,2	34404-22	34405-22	34406-22
2,3	34404-23	34405-23	34406-23
2,4	34404-24	34405-24	34406-24
2,5	34404-25	34405-25	34406-25
2,8	34404-28	34405-28	34406-28
3,0	34404-30	34405-30	34406-30

Kirschner
mit flachem Ende / with flat shaft
con extremo plano / con extremo piatto

Trokarspitze / Trocar point
Punta trocar / Punte trequarti

Ø	10 cm, 4"	15 cm, 6"	31 cm, 12 1/4"
0,8	34407-08	34408-08	34409-08
0,9	34407-09	34408-09	34409-09
1,0	34407-10	34408-10	34409-10
1,1	34407-11	34408-11	34409-11
1,2	34407-12	34408-12	34409-12
1,3	34407-13	34408-13	34409-13
1,4	34407-14	34408-14	34409-14
1,5	34407-15	34408-15	34409-15
1,6	34407-16	34408-16	34409-16
1,7	34407-17	34408-17	34409-17
1,8	34407-18	34408-18	34409-18
1,9	34407-19	34408-19	34409-19
2,0	34407-20	34408-20	34409-20
2,2	34407-22	34408-22	34409-22
2,3	34407-23	34408-23	34409-23
2,4	34407-24	34408-24	34409-24
2,5	34407-25	34408-25	34409-25
2,8	34407-28	34408-28	34409-28
3,0	34407-30	34408-30	34409-30

Kirschner
Trokarende / Trocar shaft
Punta trocar / Punte trequarti Bilaterali

Lanzenspitze / Lance point
Punta lanceolar / Punte lanceolata

Ø	31 cm, 12 1/4"
0,8	34410-08
0,9	34410-09
1,0	34410-10
1,1	34410-11
1,2	34410-12
1,3	34410-13
1,4	34410-14
1,5	34410-15
1,6	34410-16
1,7	34410-17
1,8	34410-18
1,9	34410-19
2,0	34410-20
2,2	34410-22
2,3	34410-23
2,4	34410-24
2,5	34410-25
2,8	34410-28
3,0	34410-30

Kirschner
mit flachem Ende / with flat shaft
con extremo plano / con extremo piatto

lieferbar in Packungen à 10 Stück
available in packages of 10 pieces
disponible en paquets de 10 unidades
disponibili solo in confezioni da 10 pezzi

Bohrdrähte, Knochennägel
Drill Wires, Fracture pins
Alambres, Clavos para huesos
Perforatori filiformi, Chiodi per ossa

Lanzenspitze / Lance point
Punta lanceolar / Punta lanceolata



Ø	31 cm, 12 1/4"
0,8	34411-08
0,9	34411-09
1,0	34411-10
1,1	34411-11
1,2	34411-12
1,3	34411-13
1,4	34411-14
1,5	34411-15
1,6	34411-16
1,7	34411-17
1,8	34411-18
1,9	34411-19
2,0	34411-20
2,2	34411-22
2,3	34411-23
2,4	34411-24
2,5	34411-25
2,8	34411-28
3,0	34411-30

Kirschner

mit rundem Ende / with round shaft
con extremo redondo / con extremo rotondo

Trokarspitze / Trocar point
Punta trocar / Punta trequarti



	Ø	Ø	Ø	Ø	Ø	Ø	Ø
	3,5 mm	4,0 mm	4,5 mm	4,8 mm	5,0 mm	5,5 mm	6,0 mm
8 cm, 3 1/4"	34412-08	34413-08	34415-08	34416-08	34417-08	34418-08	34419-08
10 cm, 4"	34412-10	34413-10	34415-10	34416-10	34417-10	34418-10	34419-10
12 cm, 4 3/4"	34412-12	34413-12	34415-12	34416-12	34417-12	34418-12	34419-12
14 cm, 5 1/2"	34412-14	34413-14	34415-14	34416-14	34417-14	34418-14	34419-14
16 cm, 6 1/4"	34412-16	34413-16	34415-16	34416-16	34417-16	34418-16	34419-16
18 cm, 7"	34412-18	34413-18	34415-18	34416-18	34417-18	34418-18	34419-18
20 cm, 8"	34412-20	34413-20	34415-20	34416-20	34417-20	34418-20	34419-20
22 cm, 8 3/4"	34412-22	34413-22	34415-22	34416-22	34417-22	34418-22	34419-22
23 cm, 9"	34412-23	34413-23	34415-23	34416-23	34417-23	34418-23	34419-23
24 cm, 9 1/2"	34412-24	34413-24	34415-24	34416-24	34417-24	34418-24	34419-24
26 cm, 10 1/4"	34412-26	34413-26	34415-26	34416-26	34417-26	34418-26	34419-26
28 cm, 11"	34412-28	34413-28	34415-28	34416-28	34417-28	34418-28	34419-28
30 cm, 11 1/4"	34412-30	34413-30	34415-30	34416-30	34417-30	34418-30	34419-30

Steinmann

mit rundem Ende / with round shaft
con extremo redondo / con extremo rotondo

Trokarspitze / Trocar point
Punta trocar / Punte trequarti



	Ø	Ø	Ø	Ø	Ø	Ø	Ø	Ø
	3,5 mm	4,0 mm	4,2 mm	4,5 mm	4,8 mm	5,0 mm	5,5 mm	6,0 mm
8 cm, 3 1/4"	34420-08	34421-08	34422-08	34423-08	34424-08	34425-08	34426-08	34427-08
10 cm, 4"	34420-10	34421-10	34422-10	34423-10	34424-10	34425-10	34426-10	34427-10
12 cm, 4 3/4"	34420-12	34421-12	34422-12	34423-12	34424-12	34425-12	34426-12	34427-12
14 cm, 5 1/2"	34420-14	34421-14	34422-14	34423-14	34424-14	34425-14	34426-14	34427-14
16 cm, 6 1/4"	34420-16	34421-16	34422-16	34423-16	34424-16	34425-16	34426-16	34427-16
18 cm, 7"	34420-18	34421-18	34422-18	34423-18	34424-18	34425-18	34426-18	34427-18
20 cm, 8"	34420-20	34421-20	34422-20	34423-20	34424-20	34425-20	34426-20	34427-20
22 cm, 8 3/4"	34420-22	34421-22	34422-22	34423-22	34424-22	34425-22	34426-22	34427-22
23 cm, 9"	34420-23	34421-23	34422-23	34423-23	34424-23	34425-23	34426-23	34427-23
24 cm, 9 1/2"	34420-24	34421-24	34422-24	34423-24	34424-24	34425-24	34426-24	34427-24
26 cm, 10 1/4"	34420-26	34421-26	34422-26	34423-26	34424-26	34425-26	34426-26	34427-26
28 cm, 11"	34420-28	34421-28	34422-28	34423-28	34424-28	34425-28	34426-28	34427-28
30 cm, 11 1/4"	34420-30	34421-30	34422-30	34423-30	34424-30	34425-30	34426-30	34427-30

Steinmann

Trokarende / Trocar shaft
Punta trocar / Punte trequarti Bilateralis

Knochennägel
Fracture pins
Clavos para huesos
Chiodi per ossa

lieferbar in Packungen à 10 Stück
available in packages of 10 pieces
disponible en paquets de 10 unidades
disponibili solo in confezioni da 10 pezzi

Trokarspitze / Trocar point
Punta trocar / Punta trequarti

	Ø	Ø	Ø	Ø	Ø	Ø	Ø	Ø
	3,5 mm	4,0 mm	4,2 mm	4,5 mm	4,8 mm	5,0 mm	5,5 mm	6,0 mm
8 cm, 3 1/4"	34428-08	34429-08	34430-08	34431-08	34432-08	34433-08	34434-08	34435-08
10 cm, 4"	34428-10	34429-10	34430-10	34431-10	34432-10	34433-10	34434-10	34435-10
12 cm, 4 3/4"	34428-12	34429-12	34430-12	34431-12	34432-12	34433-12	34434-12	34435-12
14 cm, 5 1/2"	34428-14	34429-14	34430-14	34431-14	34432-14	34433-14	34434-14	34435-14
16 cm, 6 1/4"	34428-16	34429-16	34430-16	34431-16	34432-16	34433-16	34434-16	34435-16
18 cm, 7"	34428-18	34429-18	34430-18	34431-18	34432-18	34433-18	34434-18	34435-18
20 cm, 8"	34428-20	34429-20	34430-20	34431-20	34432-20	34433-20	34434-20	34435-20
22 cm, 8 3/4"	34428-22	34429-22	34430-22	34431-22	34432-22	34433-22	34434-22	34435-22
23 cm, 9"	34428-23	34429-23	34430-23	34431-23	34432-23	34433-23	34434-23	34435-23
24 cm, 9 1/2"	34428-24	34429-24	34430-24	34431-24	34432-24	34433-24	34434-24	34435-24
26 cm, 10 1/4"	34428-26	34429-26	34430-26	34431-26	34432-26	34433-26	34434-26	34435-26
28 cm, 11"	34428-28	34429-28	34430-28	34431-28	34432-28	34433-28	34434-28	34435-28
30 cm, 11 3/4"	34428-30	34429-30	34430-30	34431-30	34432-30	34433-30	34434-30	34435-30

Steinmann

mit 3-kant-Ende / with triangular end
con extremo triangular / con estremo triangolare

Trokarspitze / Trocar point
Punta trocar / Punta trequarti

	Ø	15 cm, 6"	18 cm, 7"	20 cm, 8"	23 cm, 9"	25 cm, 10"	31 cm, 12 1/4"
mit Gewinde threaded Wires	1,2	34436-12	34437-12	34438-12	34439-12	34440-12	34441-12
con rosca	1,4	34436-14	34437-14	34438-14	34439-14	34440-14	34441-14
con filetto	1,6	34436-16	34437-16	34438-16	34439-16	34440-16	34441-16
	1,8	34436-18	34437-18	34438-18	34439-18	34440-18	34441-18
	2,0	34436-20	34437-20	34438-20	34439-20	34440-20	34441-20
	2,4	34436-24	34437-24	34438-24	34439-24	34440-24	34441-24
	2,5	34436-25	34437-25	34438-25	34439-25	34440-25	34441-25
	2,8	34436-28	34437-28	34438-28	34439-28	34440-28	34441-28
	3,0	34436-30	34437-30	34438-30	34439-30	34440-30	34441-30
	3,2	34436-32	34437-32	34438-32	34439-32	34440-32	34441-32
	3,5	34436-35	34437-35	34438-35	34439-35	34440-35	34441-35

mit rundem Ende / with round shaft
con extremo redondo / con estremo rotondo

lieferbar in Packungen à 10 Stück
available in packages of 10 pieces
disponible en paquets de 10 unidades
disponibili solo in confezioni da 10 pezzi

Knochennägel
Fracture pins
Clavos para huesos
Chiodi per ossa

Trokarspitze / Trocar point
Punta trocar / Punta trequarti

mit Gewinde
threaded Wires
con rosca
con filetto



Ø	15 cm, 6"	18 cm, 7"	20 cm, 8"	23 cm, 9"	25 cm, 10"	31 cm, 12 1/4"
1,2	34442-12	34443-12	34444-12	34445-12	34446-12	34447-12
1,4	34442-14	34443-14	34444-14	34445-14	34446-14	34447-14
1,6	34442-16	34443-16	34444-16	34445-16	34446-16	34447-16
1,8	34442-18	34443-18	34444-18	34445-18	34446-18	34447-18
2,0	34442-20	34443-20	34444-20	34445-20	34446-20	34447-20
2,4	34442-24	34443-24	34444-24	34445-24	34446-24	34447-24
2,5	34442-25	34443-25	34444-25	34445-25	34446-25	34447-25
2,8	34442-28	34443-28	34444-28	34445-28	34446-28	34447-28
3,0	34442-30	34443-30	34444-30	34445-30	34446-30	34447-30
3,2	34442-32	34443-32	34444-32	34445-32	34446-32	34447-32
3,5	34442-35	34443-35	34444-35	34445-35	34446-35	34447-35

Trokarende / Trocar shaft
Punta trocar / Punta trequarti

Bohrdrahtspender
 K-Wire Dispenser
 Dispensador para brocas filiformes
 Distributore per fili

12 cm, 4 3/4"



34450-08 0,8 mm
 34450-10 1,0 mm
 34450-12 1,2 mm
 34450-14 1,4 mm
 34450-15 1,5 mm
 34450-18 1,8 mm
 34450-20 2,0 mm
 34450-22 2,2 mm
 34450-25 2,5 mm
 34450-30 3,0 mm

17 cm, 6 3/4"



34460-08 0,8 mm
 34460-10 1,0 mm
 34460-12 1,2 mm
 34460-14 1,4 mm
 34460-15 1,5 mm
 34460-16 1,6 mm
 34460-20 2,0 mm
 34460-22 2,2 mm
 34460-25 2,5 mm
 34460-30 3,0 mm

33 cm, 13"



34470-08 0,8 mm
 34470-10 1,0 mm
 34470-12 1,2 mm
 34470-14 1,4 mm
 34470-15 1,5 mm
 34470-16 1,6 mm
 34470-20 2,0 mm
 34470-22 2,2 mm
 34470-25 2,5 mm
 34470-30 3,0 mm

Fingerschützer, Drahtgeflecht
 Finger Protectors, Wire gauze
 Dedales, Gasa metálica
 Proteggidita, maglia metallica per estensione



34480-01



34480-02



34480-03

LANGENBECK
 34480-01 - 34480-03



34492-01
 klein / small / pequeño / stretto

34492-02
 mittel / medium / mediano / medio

34492-03
 groß / large / grande / grande

34492-01 - 34492-03

sterilisierbar
 sterilizable
 esterilizable
 sterilizzabile

Extensionsbügel
 Extension Bows
 Estribos para extensión
 Archi per estensione

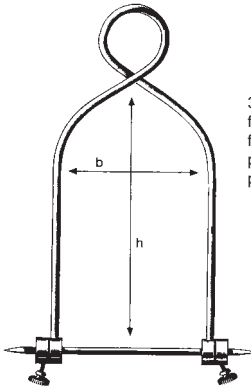

34502-16
 für Arm
 for arm
 para brazo
 per braccio
 16 x 9 cm
 6 1/4" x 3 1/2"

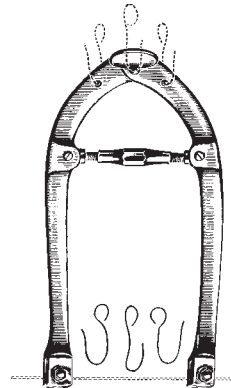

KIRSCHNER

- BÖHLER**
 34502-15 21 x 15 cm 8 1/2" x 6"
 34502-21 21 x 11 cm 8 1/2" x 4 3/8"
 für Oberschenkel und Knie
 for thigh and knee
 para femur y rodilla
 per femore e ginocchio

- 34514-18 40 - 140 mm x 115 mm mit 3 Zughaken
 with 3 hooks
 con 3 ganchos
 con 3 ganci per trazione
 34514-27 60 - 220 mm x 175 mm mit 3 Zughaken
 with 3 hooks
 con 3 ganchos
 con 3 ganci per trazione

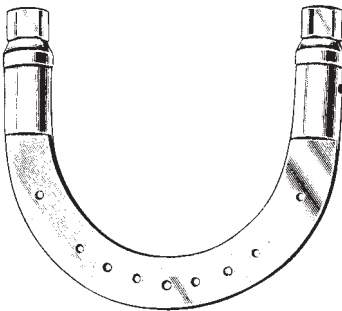

KIRSCHNER

- 34515-09 9,5 x 7,0 cm 3 3/4" x 2 3/4"
 34515-10 9,5 x 11,0 cm 3 3/4" x 4 3/8"
 34515-11 10,5 x 10,0 cm 4.1" x 4"
 34515-12 12,0 x 12,0 cm 4 3/4" x 4 3/4"
 34515-13 13,5 x 13,0 cm 5 1/2" x 5 1/8"
 34515-15 15,5 x 15,5 cm 6" x 6"
 34515-20 20,0 x 15,5 cm 8" x 6"

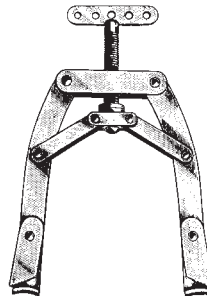

KIRSCHNER U.S.

- 34518-01
 mittel, medium, mediano, max. 130 mm (5 1/8")
 34518-02
 groß, large, grande, grande, max. 185 mm (7 1/4")
 34518-03
 extra groß, large extra long, muy grande, max. 220 mm (8 3/4")

Mutterschlüssel, Spanschlüssel
Screw nut wrench, Wire strainer
llave de tuercas, Tensor de taladros, alambres
Chiave per madreviti, Strumenti tenditore



34515-01

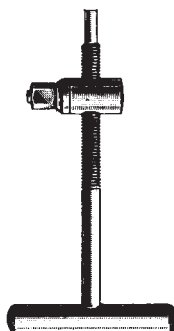

34515-02

Zughaken
hooks
ganchos
ganci per trazione

KIRSCHNER
34519-01KIRSCHNER
34519-02

Knochendraht
Bone wire
Hilos para huesos
Filo per ossa

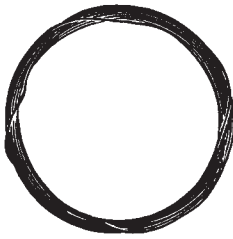

weich, in Ringen zu 10 m (32,8 Feet)
soft, in coils of 10 m (32,8 Feet)
blando, de 10 m (32,8 Feet)
morbido, 10 m (32,8 Feet)

Material:
nichtrostender Implantatstahl
nach DIN 17443 (ISO 5832/1)

	mm Ø
34520-02	0,2
34520-03	0,3
34520-04	0,4
34520-05	0,5
34520-06	0,6
34520-07	0,7
34520-08	0,8
34520-09	0,9
34520-10	1,0
34520-12	1,2
34520-15	1,5

Drahtumführungsadeln, Drahtspanninstrumente
 Bone wire guides, Bone wire tighteners
 Agujas pasa-hilos, Tensor cierra-hilos
 Aghi passafili, Strumenti tendifili



DEMEL
 27 cm, 10 1/2"

- Fig. 1 34528-01
- Fig. 2 34528-02
- Fig. 3 34528-03

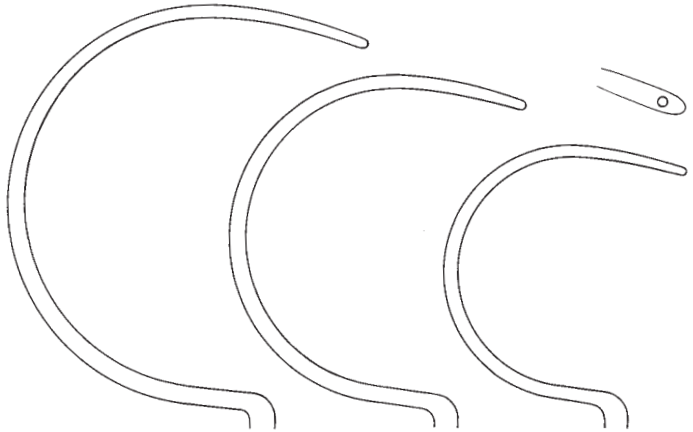
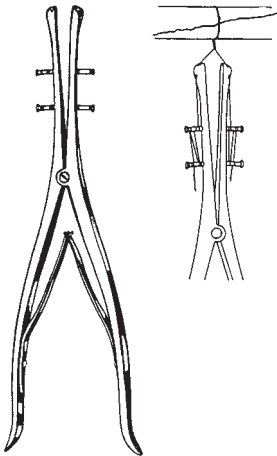

Fig. 1

Fig. 2

Fig. 3



DEMEL
 34530-28 28 cm, 11"



LOUTE
 34531-21 21 cm, 8 1/4"

Flachzangen, Faßzangen
 Flat Nose Pliers, Seizing Forceps
 Alicates planos, Pinzas para coger alambres
 Tenaglie piate, Tenaglie per afferrare



17 cm, 6 3/4"
 34533-17 INOX



GRIP
 18 cm, 7"
 34534-18 INOX



34534-15
 15 cm, 6"



34535-16
 16 cm, 6 1/4"

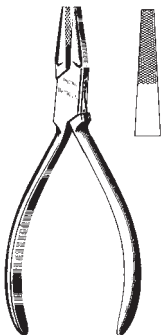

34536-14
 14 cm, 5 1/2"



34537-19
 19 cm, 7 1/2"



2 mm 4 mm 6 mm
 34538-01 34538-02 34538-03
 34539-01 TC 34539-02 TC 34539-03 TC

18 cm, 7"

Flachzangen, Drahtkneifzangen
 Flat Nose Pliers, Wire cutting Pliers
 Alicates planos, Alicates para cortar alambres
 Tenaglie piatte, Tenaglie tagliafilati



34540-01



34540-02



17 cm, 6 3/4"

34540-16
16 cm, 6 1/2"soft wire 2,0 mm
hard wire 2,0 mm34540-18
18 cm, 7"

34541-23 23 cm, 9"

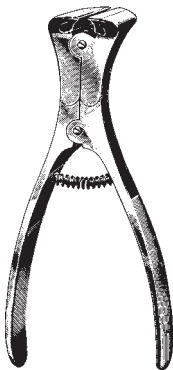
soft wire 3,0 mm
hard wire 2,2 mm

34542-15 TC 15 cm, 6"

Soft wire 2,0 mm
hard wire 1,5 mm

34543-23 23 cm, 9"

Soft wire 3,5 mm
hard wire 2,5 mm

34544-18 TC 18 cm, 7"

Soft wire 2,5 mm
hard wire 1,5 mm

Drahtkneifzangen, Drahtfaßzangen
Wire Cutting Pliers, Wire Seizing Forceps
Alicates para cortar alambres, Pinzas para coger alambres
Tronchese taglienti, Tenaglie per afferrare i fili



für harten Draht bis
2,2 mm Ø
for hard wires up to
2,2 mm Ø
para hilos duros
hasta 2,2 mm Ø
per fili duri a
2,2 mm Ø

für weichen Draht bis
2,5 mm Ø
for soft wires up to
2,5 mm Ø
para hilos blandos
hasta 2,5 mm Ø
per fili dolci fino a
2,5 mm Ø

34545-22 TC 22 cm, 10 1/2"

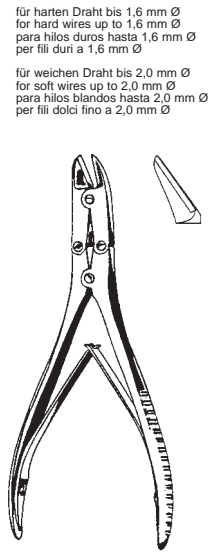

für harten Draht bis 1,6 mm Ø
for hard wires up to 1,6 mm Ø
para hilos duros hasta 1,6 mm Ø
per fili duri a 1,6 mm Ø

für weichen Draht bis 2,0 mm Ø
for soft wires up to 2,0 mm Ø
para hilos blandos hasta 2,0 mm Ø
per fili dolci fino a 2,0 mm Ø

34546-16 16 cm, 6 1/4"
34546-18 18 cm, 7"

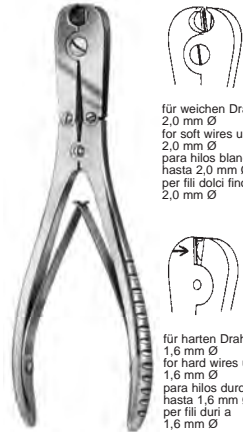

für weichen Draht bis
2,0 mm Ø
for soft wires up to
2,0 mm Ø
para hilos blandos
hasta 2,0 mm Ø
per fili dolci fino a
2,0 mm Ø



für harten Draht bis
1,6 mm Ø
for hard wires up to
1,6 mm Ø
para hilos duros
hasta 1,6 mm Ø
per fili duri a
1,6 mm Ø

34548-18 18 cm, 7"



soft wire 1,5 mm
hard wire 1,0 mm

34549-14 14 cm, 5 1/2"



34550-13 13 cm, 5 1/8"
34550-18 18 cm, 7"

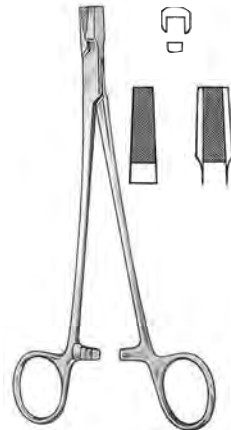

17 cm, 6 3/4"
34551-17 TC

Drahtzangen
Wire Twisting Forceps
Pinzas para torcer hilos
Pinza torcifili



CORWIN-HEGAR
34552-16 TC 16 cm, 6 1/4"



BERRY
34556-18 TC 18 cm, 7"



MAYO-HABERISSER
TC

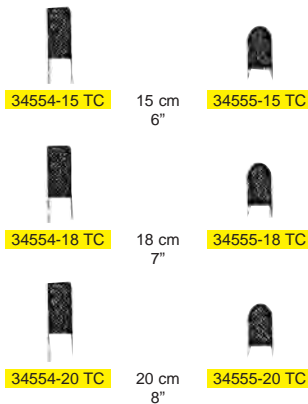

Drahtkneifzange für Draht bis 6 mm Ø
 Pin cutter for pins up to 6 mm
 Alicates para cortar clavos hasta 6 mm
 Ghigliottina per tagliare fili fino a 6 mm



34558-32 32 cm, 12 1/2"

bis 2.2 mm
 up to 2.2 mm
 hasta 2.2 mm
 a 2.2 mm



34559-47 47 cm, 18 1/2"

bis 6 mm
 up to 6 mm
 hasta 6 mm
 a 6 mm



34560-57 57 cm 22 1/2"

bis 6.5 mm
 up to 6.5 mm
 hasta 6.5 mm
 a 6.5 mm

Instrumentarium für Ender und Küntscher Nägel
 Instruments for ender and Küntscher Nails
 Instrumental para Clavos Ender y Küntscher
 Strumentario per chiodi di Ender e Küntscher

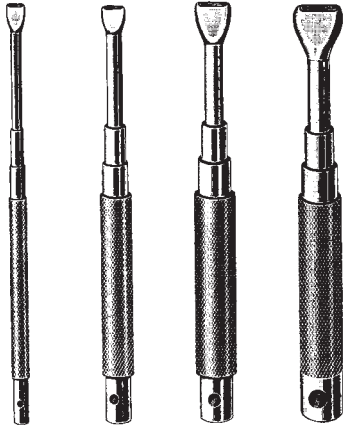

34562-24 f./p. Ø 2,4 mm
 34562-32 3,2 mm
 34562-48 4,8 mm
 34562-64 6,4 mm

Ein- und Ausschlaginstrumente für Ender-Nägel
 Driver-extractors for Ender nails
 Impactores-Extractores para clavos de Ender
 Impattore-Estrattore per chiodi di Ender

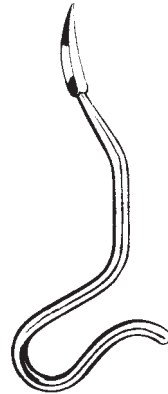

KÜNTSCHER 26 cm, 10 1/4"
 34570-01 8 mm
 34570-02 10 mm

Vorböhrer zum Öffnen der Markhöhle
 Reamers for medullary cave
 Perforadores para la cavidad medular
 Alesatore per l'apertura del midollo



KÜNTSCHER
 34573-35 35 cm, 13 3/4"
 Aufreiber für Oberschenkel
 Reamer for femur
 Perforador para fémur
 Alesatore per femore



Führungsspieße
 Guide pins
 Guía-conductora para clavos medulares
 Guida conduttrice

mm Ø L = 60 cm, 23 3/4"
 3,5 34583-60
 4,0 34584-60
 5,0 34585-60



KÜNTSCHER 19 cm, 7 1/2"
 für Nägel
 for nails
 para clavos
 per chiodi
 Ø 6-8 mm
 34588-01
 Ø 9-12 mm
 34588-02
 Ø 12-17 mm
 34588-03
 Fertigschläger
 Nail impactors
 Impactor final
 Impattore finale

Instrumentarium für Küntscher Nägel
 Instruments for Küntscher Nails
 Instrumental para Clavos Küntscher
 Strumentario per chiodi di Küntscher



34590-01

34590-02

KÜNTSCHER 63 cm, 24 3/4"
 34590-00 komplett mit 2 Haken 34590-01/02
 34590-00 complete with 2 hooks 34590-01/02
 34590-00 completo con 2 ganchos 34590-01/02
 34590-00 completo con 2 ganci 34590-01/02



Extraktionshaken
 Extraction hooks
 Ganchos extractores
 Gancio d'estrazione

cm
 34596-29 29, 11.4"
 34596-37 37, 14.5"
 34596-42 42, 16.5"
 34596-49 49, 19.3"

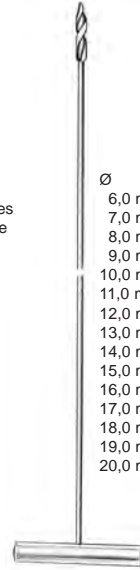

Ø
 6,0 mm 34597-06
 7,0 mm 34597-07
 8,0 mm 34597-08
 9,0 mm 34597-09
 10,0 mm 34597-10
 11,0 mm 34597-11
 12,0 mm 34597-12
 13,0 mm 34597-13
 14,0 mm 34597-14
 15,0 mm 34597-15
 16,0 mm 34597-16
 17,0 mm 34597-17
 18,0 mm 34597-18
 19,0 mm 34597-19
 20,0 mm 34597-20

Markraumböhrer
 Intramedullary drills
 Perforadores medulares
 Perforatore intramidollare

Extraktor / Nail extractor
 Aparato extractor / Estrattore



Einschläger / Nail inserter
 Introductor clavos / Impattatore
 34612-00



Impactor
 34613-00



Bender
 34615-00

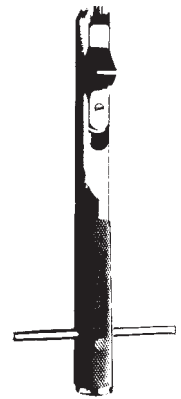

Impactor-Extractor
 Impattatore-Estrattore
 34617-00

Schraubenzieher
Screw Drivers
Destornilladores
Cacciaviti



LANE
34620-25 25 cm, 10"
Schraubenzieher 6 mm
Screw Driver 6 mm
Destornillador 6 mm
Cacciaviti 6 mm



WILLIAMS
24 cm
9 1/2"

3,5 mm
○



34624-01



34624-02



34624-03



34624-04



mit Ferrozellgriff
with Ferrozell handle
con mango de Ferrozell
con manico di Ferrozell



34628-01
25 cm
10"



34628-02
25 cm
10"



34629-01
25 cm
10"



1,5 mm
34628-15
20 cm
8"



2,5 mm
34628-25
25 cm
10"



3,5 mm
34628-35
25 cm
10"

Schraubenzieher
Screw Drivers
Destornilladores
Cacciaviti



LANE
34632-25 25 cm, 10"
Kreuzschlitzschraubenzieher
Screwdriver for cross slotted head
Destornillador para tornillos con ranura en cruz
Cacciavite a croce



Schraubenhaltehülse für Sechskantschrauben
Screw holder
Vaina para tornillos
Guaina per viti esagonali
34634-25 2,5 mm
34634-35 3,5 mm

Haltezangen, Biegehebel
 Holding Forceps, Bender
 Pinzas para sostener placas y tornillos, Palanca
 Pinza portaplacca, leva piega placche



LANE
 34637-23 23 cm, 9"

Knochenplatten-Haltezange
 Plate Holding Forceps
 Pinza para sostener placas
 Pinza portaplacche



LANE
 34639-22 22 cm, 8 3/4"

Schraubenhaltezange
 Screw Holding Forceps
 Pinza para sostener tornillos
 Pinza portaviti



LANE
 34640-18 18 cm, 7"

Biegehebel f. Knochenplatten
 Plate Bender
 Palanca para doblar placas
 Leva piegaplacche

Anlegezangen, Silberklammern
 Applying Fcps. Clips
 Pinzas aplicadoras, Grapas
 Pinza per applicare, Agrafes

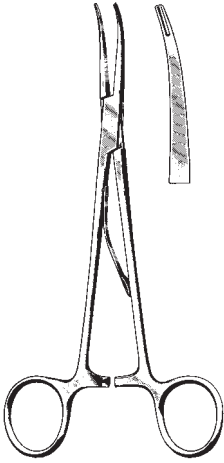

McKENZIE
 41011-15 15 cm, 6"
 41011-19 19 cm, 7 1/2"

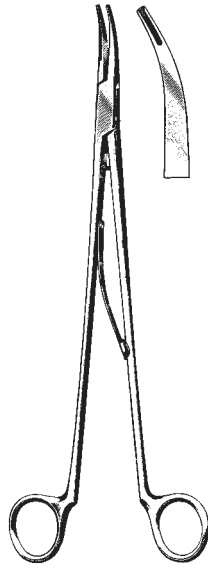

SMITHWICK
 41015-23 23 cm, 9"
 41015-26 26 cm, 10 1/4"

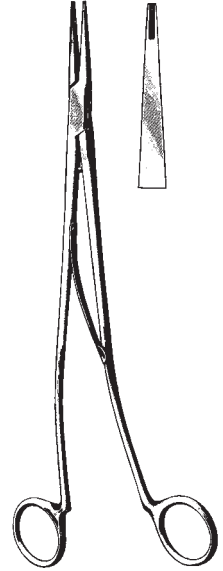

SWEET
 41017-23 23 cm, 9"
 41017-26 26 cm, 10 1/4"



OLIVECRONA-TOENNIS
 41019-14

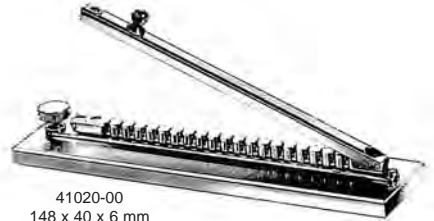

41020-00
 148 x 40 x 6 mm

Schädelhalter, Kopfhautklammer, Anlegezange
 Cervical Traction Tongs, Clips, Applying Forceps
 Pinzas de tracción craneal, Clips, Pinza para aplicar clips
 Pinze per trazione craniale, Pinza per applicare

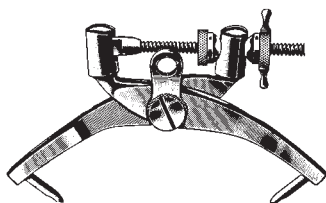

CRUTCHFIELD
41025-01



CRUTCHFIELD
41025-02



41026-35
3,5 mm Ø



41026-50
5 mm Ø

Stainless steel
Acciaio inox



RANEY
41027-00



RANEY
41028-00 16 cm, 6 1/4"

Nervhaken, Durahaken
Nerve Hooks, Dura Hooks
Ganchos para nervios y para dura-madre
Unicini per nervi e per dura-madre



DANDY
41051-20
20 cm, 8"



DANDY
41052-20
20 cm, 8"



DANDY
41053-20
20 cm, 8"



CRILE
41054-20
20 cm, 8"

Fig. 1



CUSHING
41056-18
18 cm, 7"

Fig. 2



CUSHING
41058-18
18 cm, 7"

Nervhaken, Durahaken
 Nerve Hooks, Dura Hooks
 Ganchos para nervios y para dura-madre
 Uncini per nervi e per dura-madre



GRAHAM
 41061-16
 16,5 cm, 6 1/2"



SACHS
 41064-16
 18,5 cm, 7 1/4"



ADSON
 41068-20
 20 cm, 8"



ADSON
 41069-20
 20 cm, 8"



SMITHWICK
 41070-29
 29 cm, 11.4"

Nervwurzelhaken
Nerve Root Retractors
Separadores de raiz de nervios
Uncini per le radici dei nervi

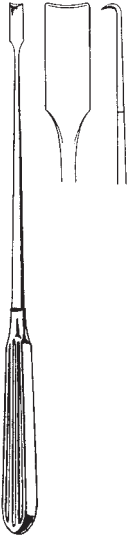

SCOVILLE
41074-23
23 cm, 9"

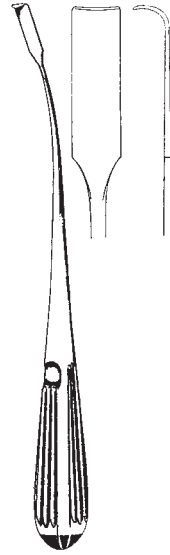

HOLSHER
41075-24
24 cm, 9 1/2"

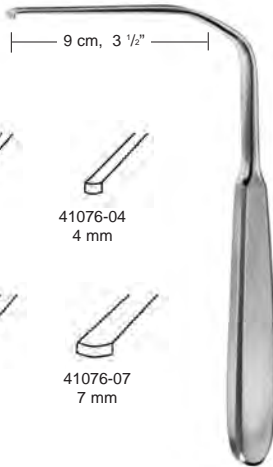

HESS
17,5 cm, 7"



41076-03
3 mm



41076-04
4 mm



41076-05
5 mm



41076-07
7 mm

Nervwurzelhaken
Nerve Root Retractors
Separadores de raíz de nervios
Uncini per le radici dei nervi



D'ERRICO
41078-23
23 cm, 9"



LOVE
41079-21
21 cm, 8 1/4"

Nervwurzelnhaken, Galea Haken
 Nerve Root Retractors, Galea Hooks
 Separadores de raiz de nervios, Gancho para galea
 Uncini per le radici dei nervi, Uncini galea

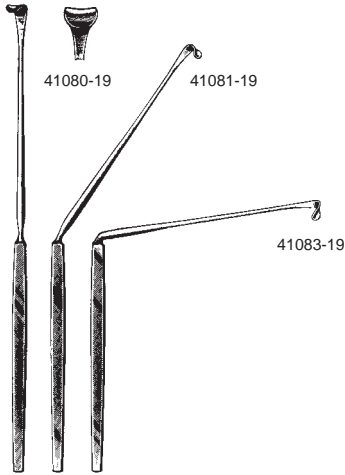

LOVE
 41080-19 – 41083-19
 19 cm, 7 1/2"

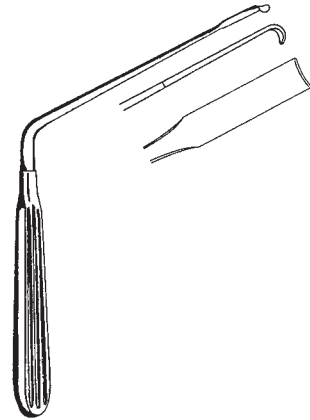

SCOVILLE
 41085-20
 20 cm, 8"



DeMARTEL
 41090-33
 33 cm, 13"



YASARGIL
 41091-31
 31 cm, 12 1/4"

Galeahaken
 Galea Hooks
 Gancho p/galea
 Gancio p/galea

Ø 7 mm

4 mm

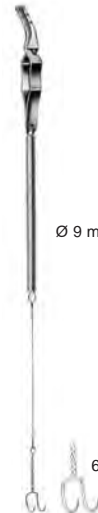

Ø 9 mm

6 mm

YASARGIL
 41091-41
 41 cm, 16"

Schädelstanze
Cranial Punch
Pinzas sacabocado craneal
Pinza per craniotomia



CONE
41097-22
22,5 cm 9°

Dura Dissektoren, Schädelzange
 Dura Dissectors, Skull Punches
 Elevadores para la duramadre, Pinzas sacabocado craneal
 Scollatori per duramadre, Pinza per craniotomia

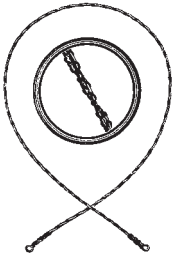

OLIVECRONA	cm	
41092-30	30,	11 3/4"
41092-40	40,	15 3/4"
41092-50	50,	19 3/4"
41092-60	60,	23 3/4"
41092-70	70,	27 1/2"



GIGLI
 41094-00



DeVILBISS
 41096-21
 21 cm, 8 1/4"

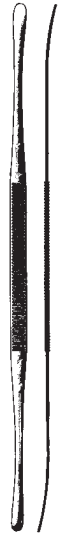

TOENNIS
 41141-25
 25 cm, 10"



SACHS
 41143-21
 21 cm, 8 1/4"



SACHS
 41145-21
 21 cm, 8 1/4"



OLIVECRONA
 41146-18 18 cm, 7"
 41146-24 24 cm, 9 1/2"

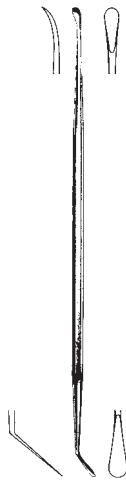

MILLIGAN
 41147-21
 21 cm, 8 1/4"



41149-22
 22 cm, 8 3/4"



DAVIS
 41151-24
 24 cm, 9 1/2"

Dura Dissektoren
Dura Dissectors
Elevadores
Scollatori

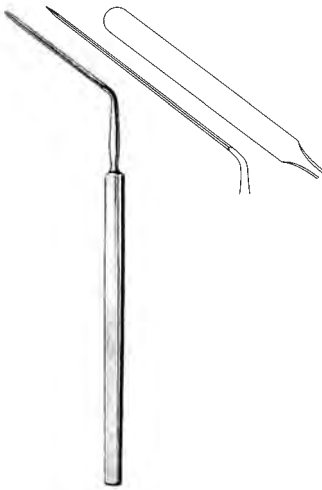

HORSLEY
41155-20
20 cm, 8"



WOODSON
41156-18
18 cm, 7"



FRAZIER
41158-01
15 cm, 6"



HOEN
41158-02
15 cm, 6"



HOEN
41158-03
15 cm, 6"



PENFIELD
41161-01
17,5 cm, 6.9"



PENFIELD
41161-02
19,5 cm, 7 3/4"



PENFIELD
41161-03
19,5 cm, 7 3/4"



PENFIELD
41161-04
21,5 cm, 8 1/2"



PENFIELD
41161-05
29 cm 11.4"

Hypophyse Pinzetten, Küretten
 Hypophyseal Forceps, Curette
 Pinzas para hipófisis, Curetas
 Pinze per ipofisi, Curette



ADSON
 41210-23
 23 cm, 9"



ADSON
 41211-23
 23 cm, 9"



ADSON
 41213-23
 23 cm, 9"



41221-00
 19 cm, 7 1/2"



41222-00
 19 cm, 7 1/2"



41223-00
 19 cm, 7 1/2"



41224-00
 19 cm, 7 1/2"

Messer, Haken, Sonden
 Knives, Hooks, Probes
 Bisturies, Ganchos, Sondas
 Bisturi, Uncino, Sonde

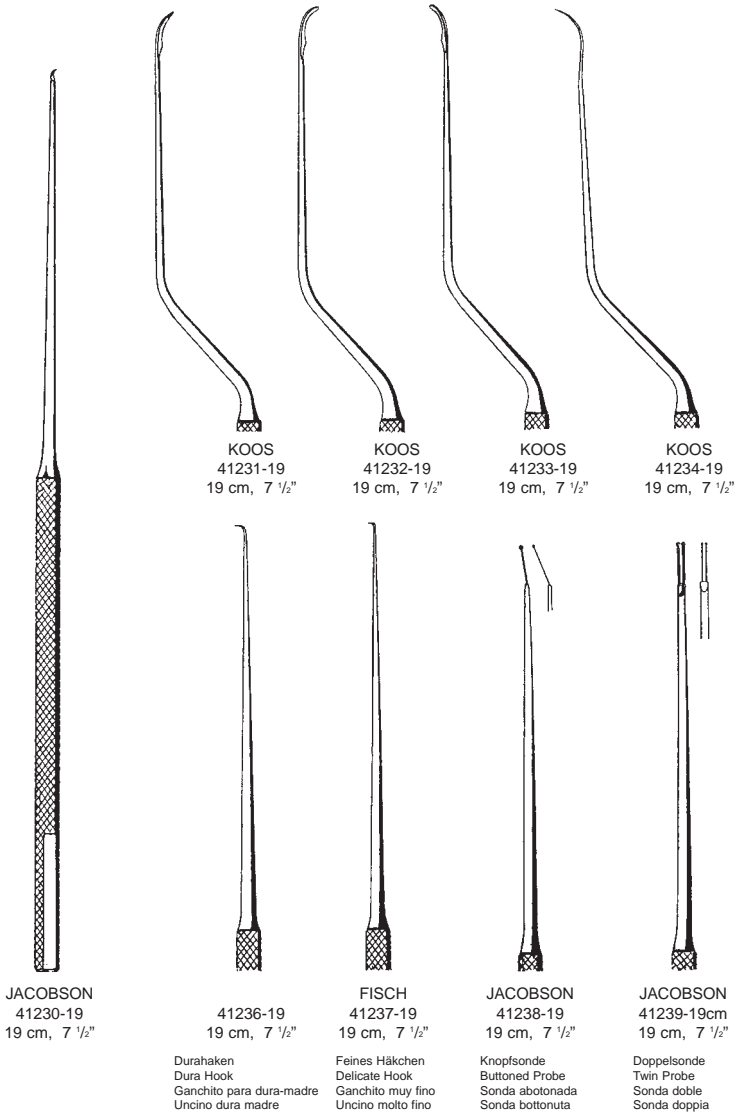

Nervhäkchen, Hirnspatel, Saugrohre
 Nerve Hooks, Brain Spatulas, Suction Tubes
 Ganchos para nervios, Espatulas cerebrales, Tubos de aspiración
 Uncini per nervi, Spatole cerebrali, Tubi aspirazioni



KRAYENBÜHL
 41242-19
 19 cm, 7 1/2"



KRAYENBÜHL
 41243-19
 19 cm, 7 1/2"



KRAYENBÜHL
 41244-19
 19 cm, 7 1/2"



KRAYENBÜHL
 41245-19
 19 cm, 7 1/2"



CUSHING
 41250-11 8x10 mm
 41250-15 13x15 mm
 41250-18 16x18 mm

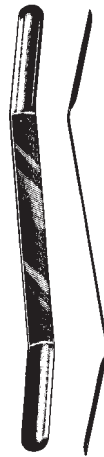

OLIVECRONA mm
 41253-07 7/ 9
 41253-11 11/13
 41253-15 15/18
 41253-18 18/22

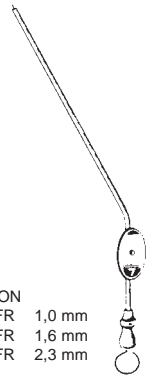

BARON
 41299-03 3FR 1,0 mm
 41299-05 5FR 1,6 mm
 41299-07 7FR 2,3 mm

Hirnspatel, Saugrohre, Punktionskanüle
 Brain Spatulas, Suction Tubes, Puncture Cannulas
 Espátulas cerebrales, Tubos de aspiración, Tubo de punción
 Spatole cerebrali, Tubi aspirazioni, cannula per punzione

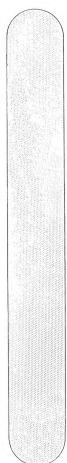

biegsam
 malleable
 malleable
 malleabile

DAVIS	18 cm, 7"
41254-06	6 mm, 1/2"
41254-10	9 mm, 3/8"
41254-13	13 mm, 1/2"
41254-16	16 mm, 5/8"
41254-19	19 mm, 3/4"
41254-25	25 mm, 1"
41254-32	32 mm, 1 1/4"
41254-38	38 mm, 1 1/2"



ADSON
 41290-21
 21 cm, 8 1/4"
 ø 4 mm



FERGUSSON
 41294-40
 18 cm, 7"
 ø 4 mm, 90°

Charr.	↔	
F.G. 30°	75°	
6	41295-06	41297-06
7	41295-07	41297-07
8	41295-08	41297-08
9	41295-09	41297-09
10	41295-10	41297-10
11	41295-11	41297-11
12	41295-12	41297-12
15	41295-15	

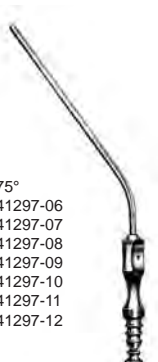

FRAZIER / FERGUSSON
 41295-06 – 41297-12
 19 cm, 7 1/2"



FRAZIER / FERGUSSON
 41298-12
 12 cm, 4 3/4" / 3 mm

Saugrohre
Suction Tubes
Tubos de aspiración
Tubi aspirazioni

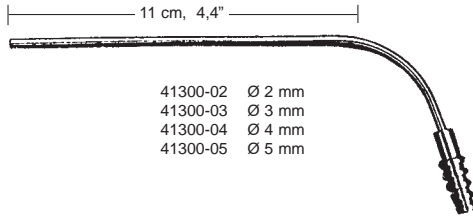

- 41300-02 Ø 2 mm
- 41300-03 Ø 3 mm
- 41300-04 Ø 4 mm
- 41300-05 Ø 5 mm

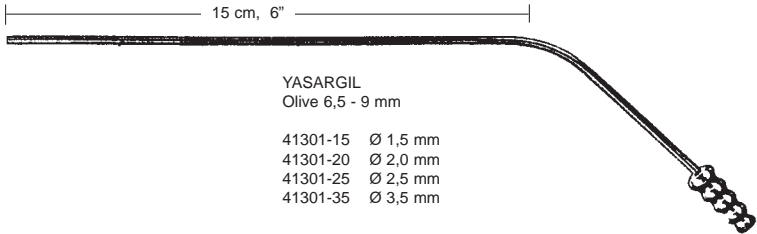

YASARGIL
Olive 6,5 - 9 mm

- 41301-15 Ø 1,5 mm
- 41301-20 Ø 2,0 mm
- 41301-25 Ø 2,5 mm
- 41301-35 Ø 3,5 mm



ZÖLLNER
41302-01



ZÖLLNER
41302-02



- 0,5 mm Ø 41306-05
- 0,7 mm Ø 41306-07
- 0,9 mm Ø 41306-09
- 1,2 mm Ø 41306-12

Kanüle für Sauggriff für Zöllner und Wullstein
Tip for Suction Handle for Zöllner and Wullstein
Cánula para mango t Zöllner y Wullstein
Cannula per manico di aspirazione t Zöllner e Wullstein

Saugrohre
Suction Tubes
Tubos de aspiración
Tubi aspirazioni

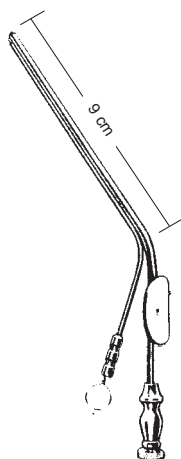

HOUSE

9 cm, 3 1/2"

41303-09	Ø 0,9 x 0,7 mm
41303-12	Ø 1,2 x 0,9 mm
41303-15	Ø 1,5 x 1,2 mm
41303-18	Ø 1,8 x 1,8 mm
41303-25	Ø 2,5 x 2,0 mm
41303-30	Ø 3,0 x 2,0 mm
41303-45	Ø 4,5 x 2,0 mm

Saugrohre, Saugkanülen
 Suction Tubes, Suction Cannulae
 Tubos de aspiración, Cánulas para aspiración
 Tubi aspirazioni, Cannule per aspirazione



Sauggriff
 Suction Handle
 Mango de aspiración
 Manico per aspirazione

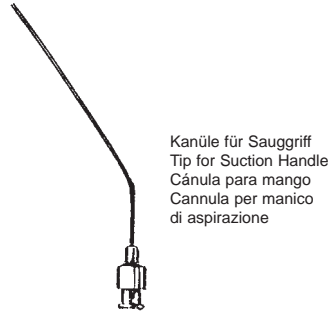

Kanüle für Sauggriff
 Tip for Suction Handle
 Cánula para mango
 Cannula per manico di aspirazione

ROSEN

0,5 mm Ø 41305-05	1,4 mm Ø 41305-14
0,6 mm Ø 41305-06	1,5 mm Ø 41305-15
0,7 mm Ø 41305-07	1,8 mm Ø 41305-18
0,8 mm Ø 41305-08	2,0 mm Ø 41305-20
0,9 mm Ø 41305-09	2,5 mm Ø 41305-25
1,0 mm Ø 41305-10	3,0 mm Ø 41305-30
1,2 mm Ø 41305-12	



Charr. 6 41304-06
 Charr. 8 41304-08
 Charr. 10 41304-10

PLESTER
 30°



biegsam
 malleable
 maleable
 malleabile

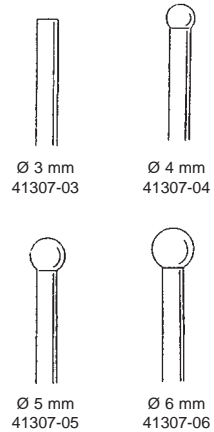

Ø 3 mm
 41307-03

Ø 4 mm
 41307-04

Ø 5 mm
 41307-05

Ø 6 mm
 41307-06

SCHMID
 15 cm, 6"

Wirbelkörperspreizer
 Lamina Spreaders
 Separadores para cuerpos vertebrales
 Divaricatori per corpi vertebrali



CLOWARD
41401-16



INGE
41405-17 – 41405-27

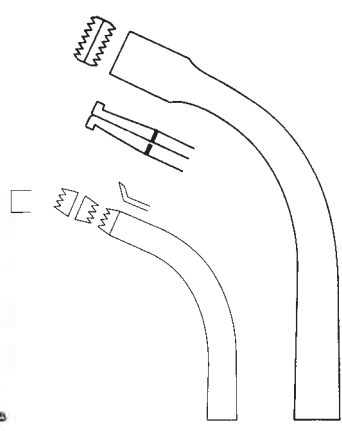

41405-17
17 cm
6 3/4"

41405-27
27 cm
10 1/2"



19 mm

CLOWARD
41406-01
12,5 cm, 5"



38 mm

CLOWARD
41406-02
7,6 cm, 3"

Laminektomie Zangen
 Laminectomy Rongeurs
 Pinzas cortantes para laminectomia
 Pinze taglianti per laminectomia



CUSHING
 2 mm



	2x10 mm	L
	41420-01	12,5 cm
	41421-01	15,0 cm
	41422-01	18,0 cm

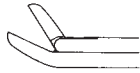

	2x10 mm/45°	L
	41420-02	12,5 cm
	41421-02	15,0 cm
	41422-02	18,0 cm

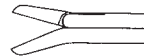

	2x10 mm/45°	L
	41420-03	12,5 cm
	41421-03	15,0 cm
	41422-03	18,0 cm

LOVE-GRUENWALD



	3x10 mm	L
	41430-01	12,5 cm
	41431-01	15,0 cm
	41432-01	18,0 cm



	3x10 mm/45°	L
	41430-02	12,5 cm
	41431-02	15,0 cm
	41432-02	18,0 cm

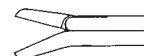

	3x10 mm/45°	L
	41430-03	12,5 cm
	41431-03	15,0 cm
	41432-03	18,0 cm

SPURLING



	4x10 mm	L
	41440-01	12,5 cm
	41441-01	15,0 cm
	41442-01	18,0 cm



	4x10 mm/45°	L
	41440-02	12,5 cm
	41441-02	15,0 cm
	41442-02	18,0 cm



	4x10 mm/45°	L
	41440-03	12,5 cm
	41441-03	15,0 cm
	41442-03	18,0 cm

Laminektomie Zangen
 Laminectomy Rongeurs
 Pinzas cortantes para laminectomia
 Pinze taglianti per laminectomia

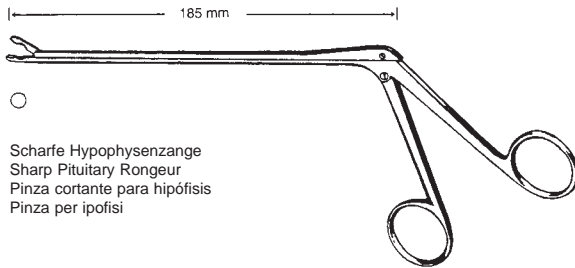

Scharfe Hypophysenzange
 Sharp Pituitary Rongeur
 Pinza cortante para hipófisis
 Pinza per ipofisi

41443-26
 25,5 cm, 10"

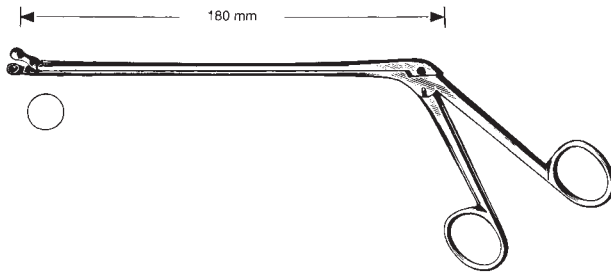

OLDBERG
 41445-25
 25 cm (9.8"), Ø 7 mm

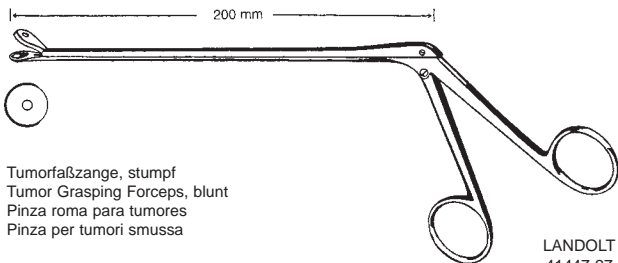

Tumorfalßzange, stumpf
 Tumor Grasping Forceps, blunt
 Pinza roma para tumores
 Pinza per tumori smussa

LANDOLT
 41447-27
 27 cm (10 1/2"), Ø 9 mm

Laminektomie Zangen
 Laminectomy Rongeurs
 Pinzas cortantes para laminectomia
 Pinze taglianti per laminectomia

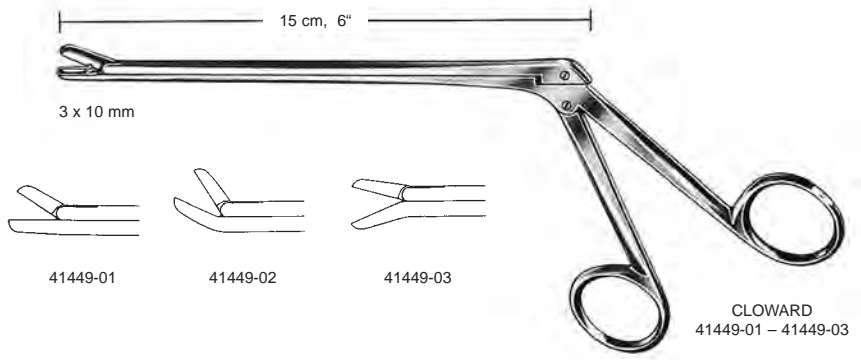
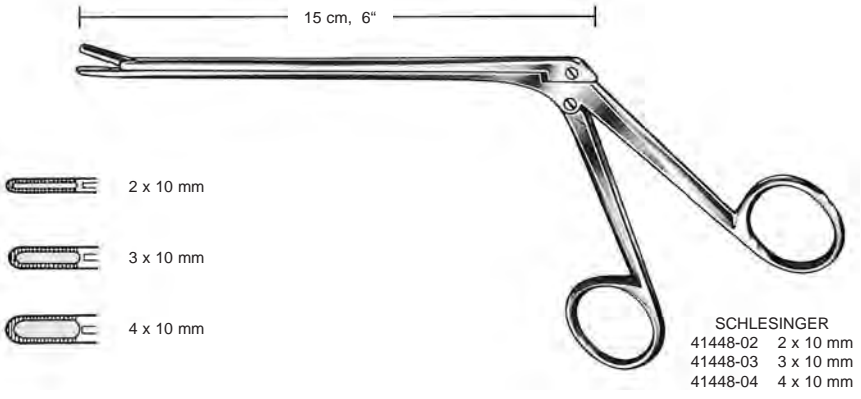

Laminektomie Zangen
 Laminectomy Rongeurs
 Pinzas cortantes para laminectomia
 Pinze taglianti per laminectomia

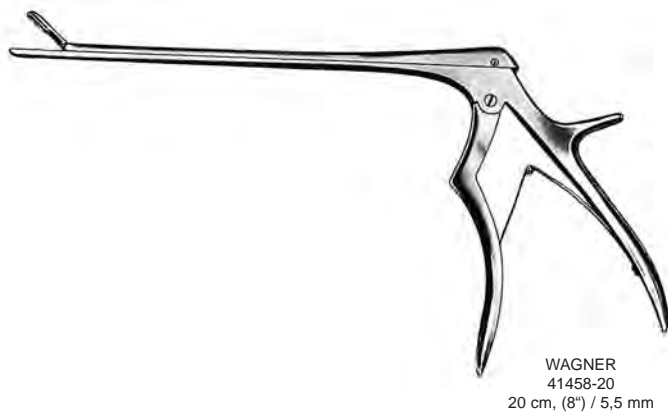
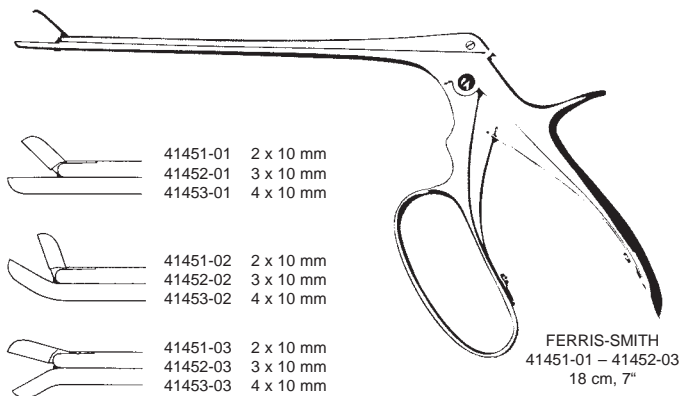

Bandscheibenstanzen
 Intervertebral Disc Rongeurs
 Pinzas sacabocado para discos intervertebrales
 Pinze taglianti per dischi intervertebrali

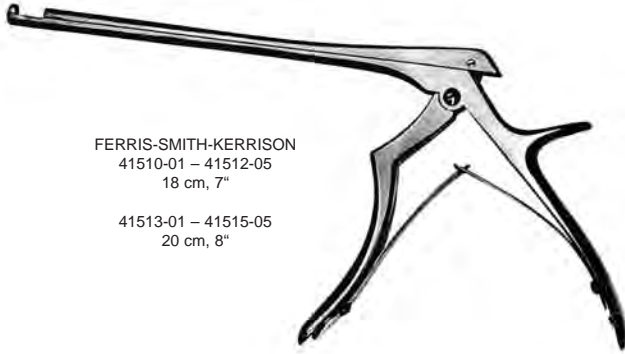

	90°	90°	40°
18 cm	41510-01 1 mm	41511-01 1 mm	41512-01 1 mm
20 cm	41513-01 1 mm	41514-01 1 mm	41515-01 1 mm
18 cm	41510-02 2 mm	41511-02 2 mm	41512-02 2 mm
20 cm	41513-02 2 mm	41514-02 2 mm	41515-02 2 mm
18 cm	41510-03 3 mm	41511-03 3 mm	41512-03 3 mm
20 cm	41513-03 3 mm	41514-03 3 mm	41515-03 3 mm
18 cm	41510-04 4 mm	41511-04 4 mm	41512-04 4 mm
20 cm	41513-04 4 mm	41514-04 4 mm	41515-04 4 mm
18 cm	41510-05 5 mm	41511-05 5 mm	41512-05 5 mm
20 cm	41513-05 5 mm	41514-05 5 mm	41515-05 5 mm

Bandscheibenstanzen
 Intervertebral Disc Rongeurs
 Pinzas sacabocado para discos intervertebrales
 Pinze taglianti per dischi intervertebrali

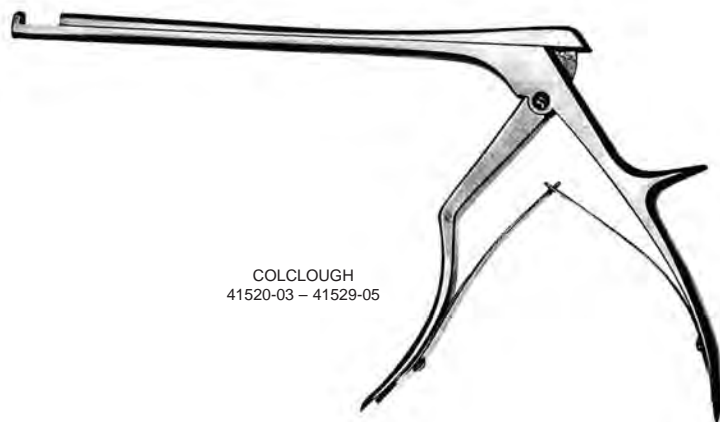

COLCLOUGH
 41520-03 – 41529-05

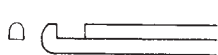

3 mm
 41520-03 15 cm, 6"
 41522-03 20 cm, 8"

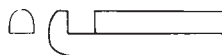

5 mm
 41520-05 15 cm, 6"
 41522-05 20 cm, 8"

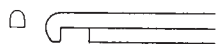

3 mm
 41524-03 15 cm, 6"
 41526-03 20 cm, 8"

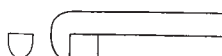

5 mm
 41524-05 15 cm, 6"
 41526-05 20 cm, 8"

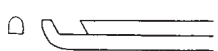

3 mm
 41527-03 15 cm, 6"
 41529-03 20 cm, 8"



5 mm
 41527-05 15 cm, 6"
 41529-05 20 cm, 8"

Zerlegbare Stanzen
Detachable punches
Pinzas cortantes desmontables
Pinze taglienti e smontabili

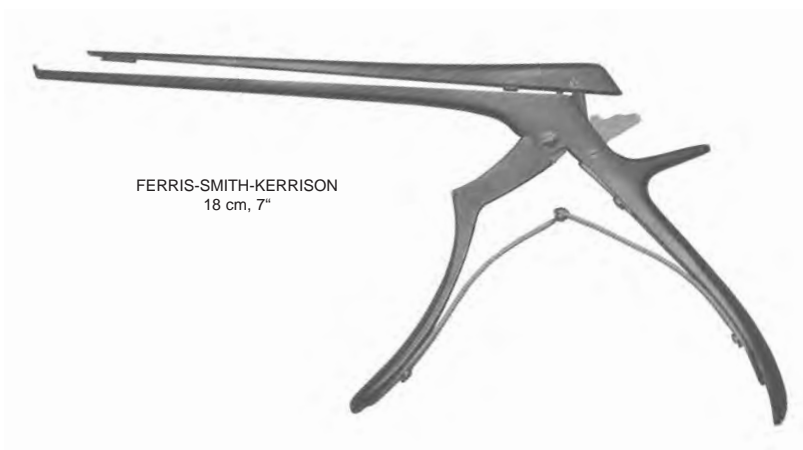

90°



41540-02 2 mm
41540-03 3 mm
41540-04 4 mm
41540-05 5 mm

130°



41542-02 2 mm
41542-03 3 mm
41542-04 4 mm
41542-05 5 mm

YASARGIL – Aneurysmen – Gefäß – Clips
 YASARGIL – Aneurysm – Vessel – Clips
 YASARGIL – Clips para aneurisma
 YASARGIL – Clips per aneurisma

aus hochwertigem Implantat-Stahl antimagnetisch
 in high quality Implant steel antimagnetic
 de acero inoxidable para implantes de alta calidad, antimagnético
 Prodotto in acciaio di alta qualità, antimagnetico

Features of the Clip

SERIAL-NUMBER

Each clip is coded with an individual serial number – marked by laser technology-
 The serial number guarantees a detailed follow-up of

- the whole production process
- the closure force
- from raw material to the final product

These informations are registered in our company for the period of 10 years.

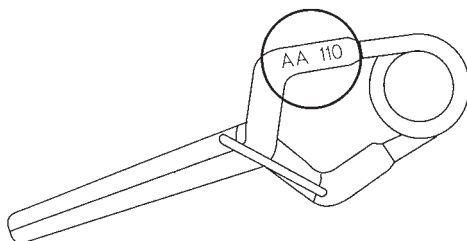

PACKING – LABELING

Each clip is individually packaged in a transparent box made of resistant plastic.
 Special wishes of customers regarding the packaging will be considered by us. This will be marked on an internal instruction.

The transparent box is marked with a label in order to assure a quick and sure identification of the clip.

On the label you can find the following data:

- catalogue number
- Product description
- Illustration
- Closing force in g
- Tolerance range of closing force
- Blade length
- Maximum opening
- Blade geometry
- Serial number
- Jaw profile
- Material description
- Lot number
- the notes "NOT STERILE"
- WARNING

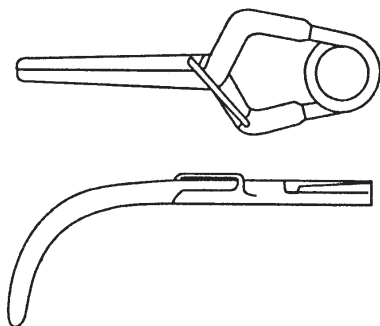

YASARGIL – Aneurysmen – Gefäß – Clips
 YASARGIL – Aneurysm – Vessel – Clips
 YASARGIL – Clips para aneurisma
 YASARGIL – Clips per aneurisma

aus hochwertigem Implantat-Stahl antimagnetisch
 in high quality Implant steel antimagnetic
 de acero inoxidable para implantes de alta calidad, antimagnético
 Prodotto in acciaio di alta qualità, antimagnetico

Features of the Clip

JAW-PROFILE

The rounded, pyramid-like structure is stamped into the jaw through a special step in production and prevents sharp edged which could perforate an aneurysm

No edges or burrs through additional rounding of structures that border the clip outer side because of this, real atraumatic application of the clip

Increased surface area due to the pyramid-like design of the jaws inner surface the cross-like structure of the inner jaws pyramid surface doubles the tissue-holding area.

The applied pressure distributes itself evenly over the length of the jaw.

The convex closure of the clip assures an atraumatic and secure closure of the aneurysm.

Sliding of the clip is prevented.

SPRING-DESIGN

The spring size, wich is different in the Standard and Mini clips, ist the same within the same type of the Clip.

Through this, the highest degree of a secure fit is ensured by the clip applicator (clip/clip applicator fit)

LINK-DESIGN

Laser welded

The link ensures the precise guidance of the jaws and a "soft" opening of the clip during the whole spreading process.

The contact surface of the jaws are guided symmetrically in an exact way "over the whole lenght" this fact guarantees an additional stability of the clip.

No over-stress of the material because the design of the link limits the maximum opening width.

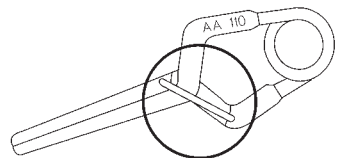
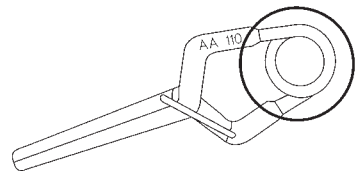
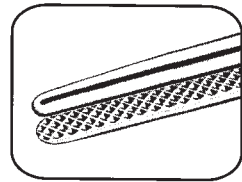
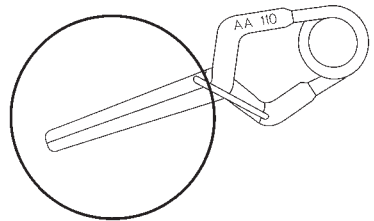

YASARGIL – Aneurysmen – Gefäß – Clips
 YASARGIL – Aneurysm – Vessel – Clips
 YASARGIL – Clips para aneurisma
 YASARGIL – Clips per aneurisma

aus hochwertigem Implantat-Stahl antimagnetisch
 in high quality Implant steel antimagnetic
 de acero inoxidable para implantes de alta calidad, antimagnético
 Prodotto in acciaio di alta qualità, antimagnetico

Features of the Clip

CLOSING-FORCE

The closing force is measured at one third of the jaw length and an opening of 0,5 mm.

The final quality control of the clip is effected by a microprocessor-controlled measuring equipment.

The closing force is indicated exactly within a certain tolerance.

By the help of a special software program we assure that before the clip passes the final quality control its closure force is fixed. As a consequence we exclude any kind of manipulation.

All relevant technical data are stored during the control procedure and printed on the label.

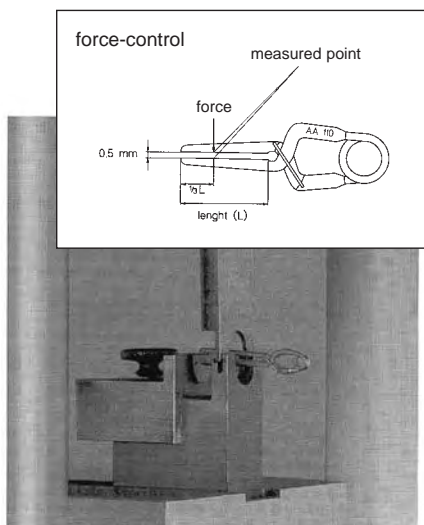

Material and Quality Assurance

According to DIN 17445, implant steel is used in the production of our Aneurysm Clip

High stability characteristics
 Excellent tissue compatibility
 Secure closure of blood vessels
 Antimagnetic
 Ideally suited as implantation material
 Security against over straining

YASARGIL – Aneurysmen – Gefäß – Clips

YASARGIL – Aneurysm – Vessel – Clips

YASARGIL – Clips para aneurisma

YASARGIL – Clips per aneurisma

aus hochwertigem Implantat-Stahl antimagnetisch
in high quality Implant steel antimagnetic
de acero inoxidable para implantes de alta calidad, antimagnético
Prodotto in acciaio di alta qualità, antimagnetico

Erklärung zum Katalog-System
Instructions for the catalogue-system
Explicaciones para el sistema del catálogo
Esempio del sistema del catalogo

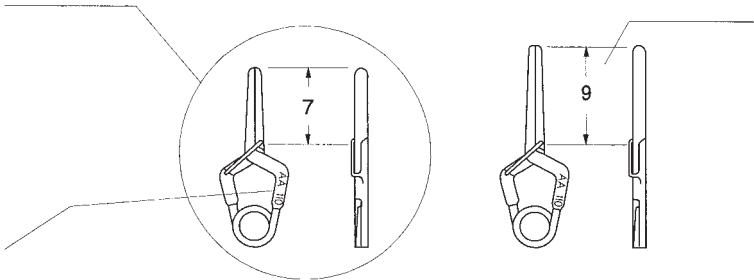

YASARGIL – Aneurysmen – Gefäß – Clips
 YASARGIL – Aneurysm – Vessel – Clips
 YASARGIL – Clips para aneurisma
 YASARGIL – Clips per aneurisma

aus hochwertigem Implantat-Stahl antimagnetisch
 in high quality Implant steel antimagnetic
 de acero inoxidable para implantes de alta calidad, antimagnético
 Prodotto in acciaio di alta qualità, antimagnetico

YASARGIL-STANDARD für permanenten Verschluss
 YASARGIL-STANDARD for permanent closure
 YASARGIL-STANDARD para cierre permanente
 YASARGIL-STANDARD con chiusura permanente

Standard

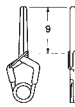
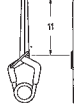
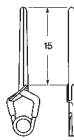
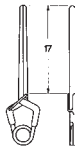
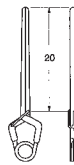
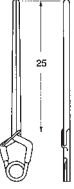
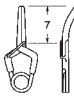
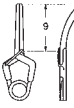
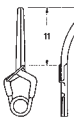
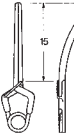
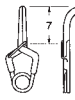
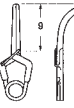
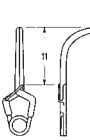
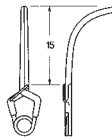
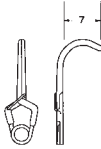
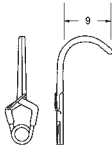
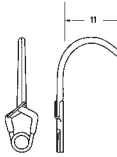
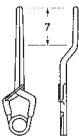
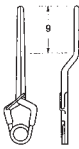
							
Cat. Nr.	41600-62 41600-62 T	41600-70 41600-70 T	41600-78 41600-78 T	41600-92 41600-92 T	41601-10 41601-10 T	41601-11 41601-11 T	
max. opening	6,2 mm	7,0 mm	7,8 mm	9,2 mm	10,6 mm	11,4 mm	
Force	150 gms	180 gms	180 gms	200 gms	200 gms	200 gms	
							
	41601-13 41601-13 T	41602-60 41602-60 T	41602-68 41602-68 T	41602-75 41602-75 T	41602-87 41602-87 T	41603-55 41603-55 T	41603-61 41603-61 T
	13,3 mm	6,0 mm	6,8 mm	7,5 mm	8,7 mm	5,5 mm	6,1 mm
	200 gms	150 gms	180 gms	180 gms	200 gms	150 gms	180 gms
							
	41603-65 41603-65 T	41603-74 41603-74 T	41604-54 41604-54 T	41604-58 41604-58 T	41604-62 41604-62 T	41604-79 41604-79 T	41604-87 41604-87 T
	6,5 mm	7,4 mm	5,4 mm	5,8 mm	6,2 mm	7,9 mm	8,7 mm
	180 gms	200 gms	180 gms	180 gms	180 gms	200 gms	200 gms

YASARGIL – Aneurysmen – Gefäß – Clips
 YASARGIL – Aneurysm – Vessel – Clips
 YASARGIL – Clips para aneurisma
 YASARGIL – Clips per aneurisma

aus hochwertigem Implantat-Stahl antimagnetisch
 in high quality Implant steel antimagnetic
 de acero inoxidable para implantes de alta calidad, antimagnético
 Prodotto in acciaio di alta qualità, antimagnetico

YASARGIL-STANDARD für permanenten Verschluss
 YASARGIL-STANDARD for permanent closure
 YASARGIL-STANDARD para cierre permanente
 YASARGIL-STANDARD con chiusura permanente

Standard

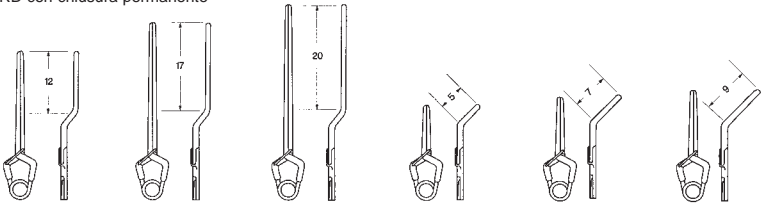

Cat. Nr.	41605-10	41605-12	41605-13	41606-62	41606-65	41606-78
	41605-10 T	41605-12 T	41605-13 T	41606-62-T	41606-65 T	41606-78 T
max. opening	10,2 mm	11,9 mm	13,0 mm	6,2 mm	6,5 mm	7,8 mm
Force	200 gms	180 gms	180 gms	200 gms	200 gms	200 gms

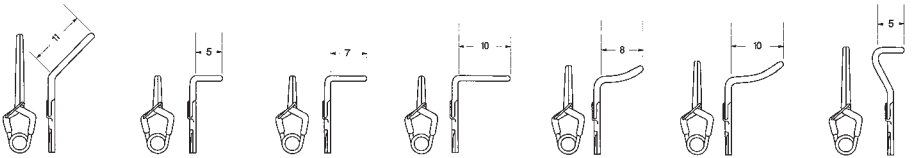

41606-84	41607-56	41607-57	41607-58	41607-59	41607-60	41607-72
41606-84 T	41607-56 T	41607-57 T	41607-58 T	41607-59 T	41607-60 T	41607-72 T
8,4 mm	5,6 mm	5,6 mm	5,6 mm	5,4 mm	5,6 mm	7,2 mm
200 gms	200 gms	200 gms	200 gms	200 gms	200 gms	200 gms

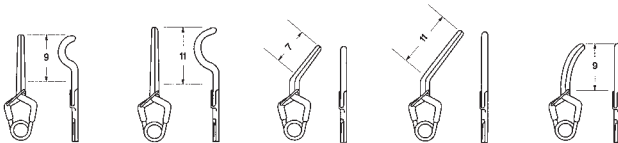

41607-73	41607-82	41608-57	41608-80	41609-70
41607-73 T	41607-82 T	41608-57 T	41608-80 T	41609-70 T
7,2 mm	8,2 mm	5,7 mm	8,0 mm	7,0 mm
200 gms	200 gms	200 gms	200 gms	200 gms

YASARGIL – Aneurysmen – Gefäß – Clips
 YASARGIL – Aneurysm – Vessel – Clips
 YASARGIL – Clips para aneurisma
 YASARGIL – Clips per aneurisma

aus hochwertigem Implantat-Stahl antimagnetisch
 in high quality Implant steel antimagnetic
 de acero inoxidable para implantes de alta calidad, antimagnético
 Prodotto in acciaio di alta qualità, antimagnetico

YASARGIL-STANDARD für temporären Verschluss
 YASARGIL-STANDARD for temporary closure
 YASARGIL-STANDARD para cierre temporal
 YASARGIL-STANDARD con chiusura temporanea

Standard

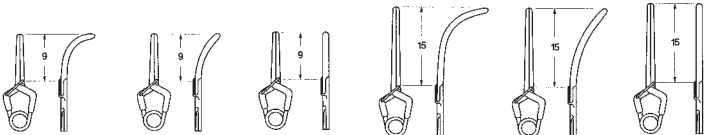

Cat. Nr.	41610-61	41610-68	41610-70	41611-74	41611-87	41611-92
	41610-61 T	41610-68 T	41610-70 T	41611-74 T	41611-87 T	41611-92 T
max. opening	6,1 mm	6,8 mm	7,0 mm	7,4 mm	8,7 mm	9,2 mm
Force	70 gms	70 gms	70 gms	70 gms	70 gms	70 gms

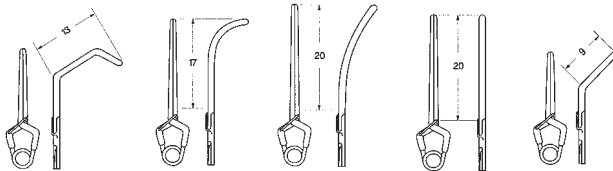

	41612-07	41612-09	41612-11	41612-12	41612-62
	41612-07 T	41612-09 T	41612-11 T	41612-12 T	41612-62 T
	7,5 mm	9,9 mm	11,0 mm	11,4 mm	6,2 mm
	90 gms	90 gms	90 gms	90 gms	70 gms

YASARGIL – Aneurysmen – Gefäß – Clips
 YASARGIL – Aneurysm – Vessel – Clips
 YASARGIL – Clips para aneurisma
 YASARGIL – Clips per aneurisma

aus hochwertigem Implantat-Stahl antimagnetisch
 in high quality Implant steel antimagnetic
 de acero inoxidable para implantes de alta calidad, antimagnético
 Prodotto in acciaio di alta qualità, antimagnetico

YASARGIL-STANDARD für permanenten Verschluss
 YASARGIL-STANDARD for permanent closure
 YASARGIL-STANDARD para cierre permanente
 YASARGIL-STANDARD con chiusura permanente

Standard

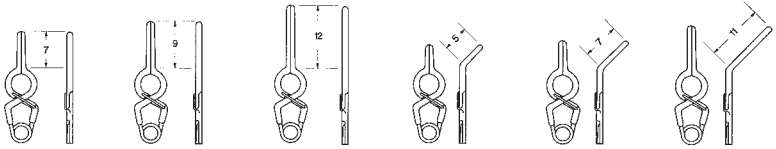

Cat. Nr.	41613-74	41613-84	41613-96	41614-58	41614-65	41614-72
	41613-74 T	41613-84 T	41613-96 T	41614-58 T	41614-65 T	41614-72 T
max. opening	7,4 mm	8,4 mm	9,6 mm	5,8 mm	6,5 mm	7,2 mm
Force	150 gms	150 gms	180 gms	150 gms	150 gms	180 gms

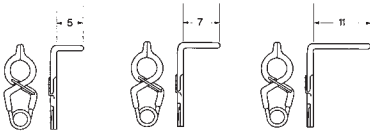

41615-49	41615-50	41615-51
41615-49 T	41615-50 T	41615-51 T
4,9 mm	4,9 mm	4,9 mm
150 gms	150 gms	180 gms

YASARGIL – Aneurysmen – Gefäß – Clips
 YASARGIL – Aneurysm – Vessel – Clips
 YASARGIL – Clips para aneurisma
 YASARGIL – Clips per aneurisma

aus hochwertigem Implantat-Stahl antimagnetisch
 in high quality Implant steel antimagnetic
 de acero inoxidable para implantes de alta calidad, antimagnético
 Prodotto in acciaio di alta qualità, antimagnetico

YASARGIL-STANDARD für permanenten Verschluss
 YASARGIL-STANDARD for permanent closure
 YASARGIL-STANDARD para cierre permanente
 YASARGIL-STANDARD con chiusura permanente

Standard

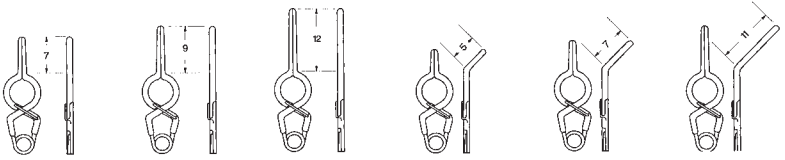

Cat. Nr.	41616-79	41616-91	41617-10	41617-65	41617-72	41617-78
	41616-79 T	41616-91 T	41617-10 T	41617-65 T	41617-72 T	41617-78 T
max. opening	7,9 mm	9,1 mm	10,3 mm	6,5 mm	7,2 mm	7,8 mm
Force	150 gms	150 gms	180 gms	150 gms	150 gms	180 gms

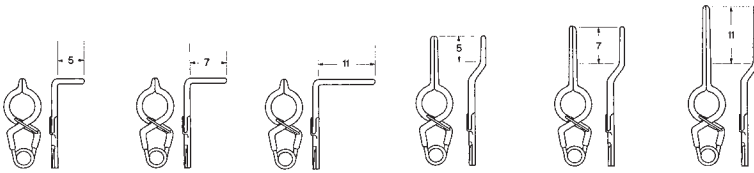



41618-55	41618-56	41618-57	41618-79	41618-88	41619-00
41618-55 T	41618-56 T	41618-57 T	41618-79 T	41618-88 T	41619-00 T
5,5 mm	5,5 mm	5,5 mm	7,9 mm	8,8 mm	10,0 mm
150 gms	150 gms	180 gms	150 gms	150 gms	180 gms

YASARGIL – Aneurysmen – Gefäß – Clips
 YASARGIL – Aneurysm – Vessel – Clips
 YASARGIL – Clips para aneurisma
 YASARGIL – Clips per aneurisma

aus hochwertigem Implantat-Stahl antimagnetisch
 in high quality Implant steel antimagnetic
 de acero inoxidable para implantes de alta calidad, antimagnético
 Prodotto in acciaio di alta qualità, antimagnetico

YASARGIL-STANDARD für permanenten Verschluss
 YASARGIL-STANDARD for permanent closure
 YASARGIL-STANDARD para cierre permanente
 YASARGIL-STANDARD con chiusura permanente

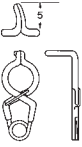
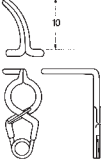
Standard

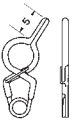
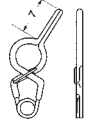
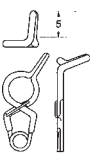
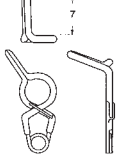
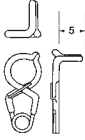
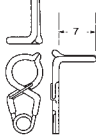
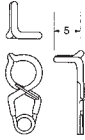





							
Cat. Nr.	41620-58	41620-59	41620-60	41620-61	41620-62	41620-63	
	41620-58 T	41620-59 T	41620-60 T	41620-61 T	41620-62 T	41620-63 T	
max. opening	5,8 mm	5,8 mm	5,8 mm	5,8 mm	5,8 mm	5,8 mm	
Force	150 gms	150 gms	150 gms	150 gms	150 gms	150 gms	
							
	41620-70	41620-78	41620-88	41621-58	41621-62	41622-58	41622-62
	41620-70 T	41620-78 T	41620-88 T	41621-58 T	41621-62 T	41622-58 T	41622-62 T
	7,0 mm	7,8 mm	8,8 mm	5,8 mm	6,2 mm	5,8 mm	6,2 mm
	150 gms	150 gms	150 gms	150 gms	150 gms	150 gms	150 gms
							
	41623-56	41624-56	41625-56	41626-56			
	41623-56 T	41624-56 T	41625-56 T	41626-56 T			
	5,6 mm	5,6 mm	5,6 mm	5,6 mm			
	150 gms	150 gms	150 gms	150 gms			







YASARGIL – Aneurysmen – Gefäß – Clips
 YASARGIL – Aneurysm – Vessel – Clips
 YASARGIL – Clips para aneurisma
 YASARGIL – Clips per aneurisma







aus hochwertigem Implantat-Stahl antimagnetisch
 in high quality Implant steel antimagnetic
 de acero inoxidable para implantes de alta calidad, antimagnético
 Prodotto in acciaio di alta qualità, antimagnetico

YASARGIL-STANDARD für permanenten Verschluss
 YASARGIL-STANDARD for permanent closure
 YASARGIL-STANDARD para cierre permanente
 YASARGIL-STANDARD con chiusura permanente

Mini

						
Cat. Nr.	41627-33	41627-40	41628-33	41628-40	41628-46	41629-32
max. opening	3,3 mm	4,0 mm	3,3 mm	4,0 mm	4,6 mm	3,2 mm
Force	110 gms	110 gms	110 gms	110 gms	110 gms	110 gms

						
41629-38	41630-36	41630-38	41631-36	41631-40	41631-44	41632-36
3,8 mm	3,6 mm	3,8 mm	3,6 mm	4,0 mm	4,4 mm	3,6 mm
110 gms	110 gms	110 gms	110 gms	110 gms	110 gms	110 gms

						
41633-35	41633-40	41634-35	41634-60	41634-70	41635-57	41636-45
3,5 mm	4,0 mm	3,5 mm	6,0 mm	7,0 mm	5,7 mm	4,5 mm
110 gms	110 gms	130 gms	130 gms	130 gms	130 gms	130 gms

YASARGIL – Aneurysmen – Gefäß – Clips
 YASARGIL – Aneurysm – Vessel – Clips
 YASARGIL – Clips para aneurisma
 YASARGIL – Clips per aneurisma

aus hochwertigem Implantat-Stahl antimagnetisch
 in high quality Implant steel antimagnetic
 de acero inoxidable para implantes de alta calidad, antimagnético
 Prodotto in acciaio di alta qualità, antimagnetico

YASARGIL-STANDARD für temporären Verschluss
 YASARGIL-STANDARD for temporary closure
 YASARGIL-STANDARD para cierre temporal
 YASARGIL-STANDARD con chiusura temporanea

Mini



Cat. Nr.	41637-33	41637-40	41638-38	41638-46	41639-44	41640-40
	41637-33 T	41637-40 T	41638-38 T	41638-46 T	41639-44 T	41640-40 T
max. opening	3,3 mm	4,0 mm	3,8 mm	4,6 mm	4,4 mm	4,0 mm
Force	50 gms	50 gms	50 gms	70 gms	70 gms	70 gms

Anlegezange mit Rundgriff – FLEXIBEL – mit und ohne drehbarem Maulteil
 Applying forceps with round shaft – FLEXIBLE – with and without Rotation
 Pinzas de aplicación con mango redondo – FLEXIBLE – con y sin rotación
 Posa clips con manico rotonda guaina FLESSIBILE cover sistema rotante ed non rotante

Länge		
Length		
Largo		
Lunghezza	MINI	STANDARD
70 mm	41641-07	41643-07
90 mm	41641-09	41643-09
110 mm	41641-11	41643-11

nicht drehbar
 non rotating
 sin rotación
 non rotante

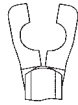

Länge		
Length		
Largo		
Lunghezza	MINI	STANDARD
70 mm	41642-07	41644-07
90 mm	41642-09	41644-09
110 mm	41642-11	41644-11

drehbar
 rotating
 rotante
 rotante

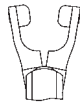

drehbar
 rotating
 rotante
 rotante

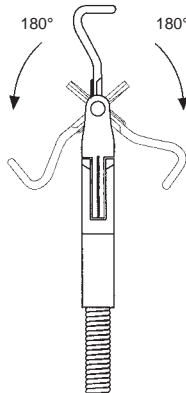

Beispiel für Drehmechanismus
 Example for Rotation
 Ejemplo de la rotación
 Esempio della rotazione

Clips drehbar im Maul
 Clips rotabile in jaw
 Clips rotabile en la boca
 Clips rotabile nel morso

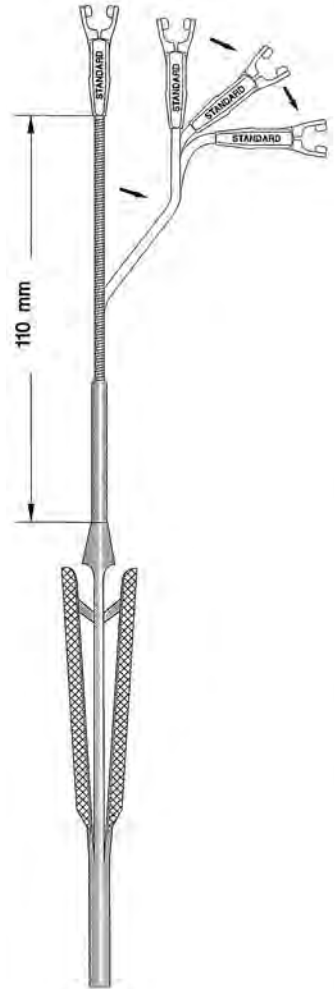

41641-07 - 41644-11

Anlegezange mit Rundgriff – starr – mit und ohne drehbarem Maulteil
 Applying forceps with round shaft – rigid – with and without Rotation
 Pinzas de aplicación con mango redondo – rígido – con y sin rotación
 Posa clips con manico rotonda guaina rigida cover sistema rotante ed non rotante

Länge		
Length		
Largo		
Lunghezza	MINI	STANDARD
70 mm	41645-07	41647-07
90 mm	41645-09	41647-09
110 mm	41645-11	41647-11

nicht drehbar
 non rotating
 sin rotación
 non rotante

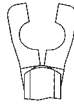

Länge		
Length		
Largo		
Lunghezza	MINI	STANDARD
70 mm	41646-07	41648-07
90 mm	41646-09	41648-09
110 mm	41646-11	41648-11

drehbar
 rotating
 rotante
 rotante



drehbar
 rotating
 rotante
 rotante

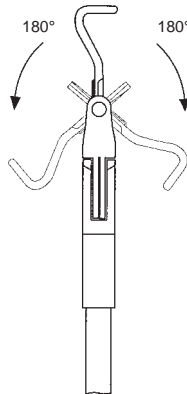

Beispiel für Drehmechanismus
 Example for Rotation
 Ejemplo de la rotación
 Esempio della rotazione

Clips drehbar im Maul
 Clips rotabile in jaw
 Clips rotabile en la boca
 Clips rotabile nel morso

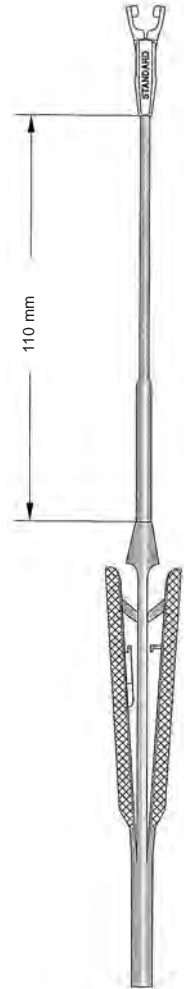

41645-07 - 41648-11

Anlegezange mit Rundgriff – starr – mit und ohne drehbarem Maulteil
 Applying forceps with round shaft – rigid – with and without Rotation
 Pinzas de aplicación con mango redondo – rígido – con y sin rotación
 Posa clips con manico rotonda guaina rigida cover sistema rotante ed non rotante

Länge		
Length		
Largo		
Lunghezza	MINI	STANDARD
70 mm	41649-07	41651-07
90 mm	41649-09	41651-09
110 mm	41649-11	41651-11

nicht drehbar
 non rotating
 sin rotación
 non rotante

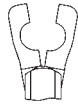

Länge		
Length		
Largo		
Lunghezza	MINI	STANDARD
70 mm	41650-07	41652-07
90 mm	41650-09	41652-09
110 mm	41650-11	41652-11

drehbar
 rotating
 rotante
 rotante

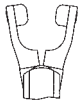

Beispiel für Drehmechanismus
 Example for Rotation
 Ejemplo de la rotación
 Esempio della rotazione

Clips drehbar im Maul
 Clips rotabile in jaw
 Clips rotabile en la boca
 Clips rotabile nel morso

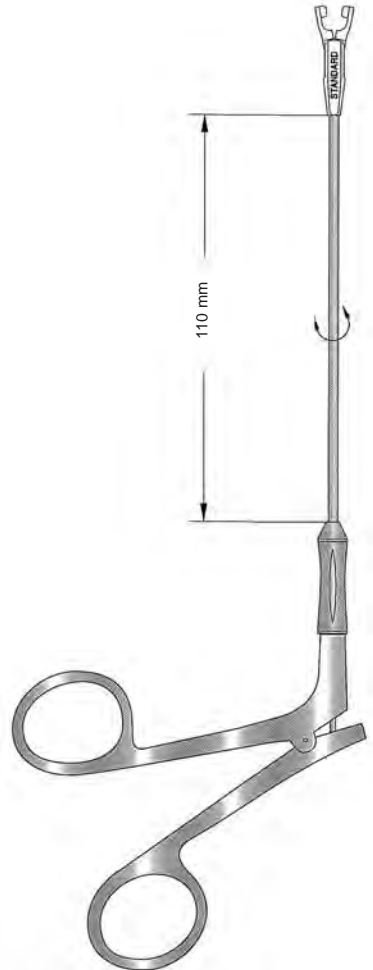
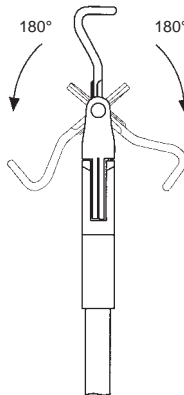

41649-07 - 41652-11

Anlegezange – mit und ohne drehbarem Maulteil
 Applying Forceps – with and without Rotation
 Pinzas de aplicación, con y sin rotación
 Pinza posa clips, con ed senza rotazione

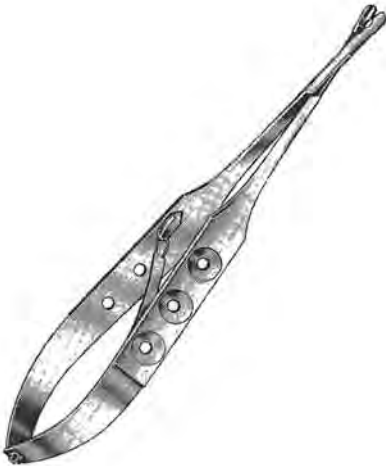

MINI	41653-18	
STANDARD	41654-18	
MINI	41655-18	drehbar / rotating rotante / rotante
STANDARD	41656-18	drehbar / rotating rotante / rotante

Anlegezange gerade, mit Sperre, Länge 18 cm, 7"
 Applying Forceps straight, with Ratchet, Length 18 cm, 7"
 Pinza de aplicación, con cremallera, 18 cm, 7"
 Posa clips, retta con bloccaggio lunghezza 18 cm, 7"





Länge			
Lenght			
Largo			
Lunghezza	17 cm, 6 3/4"	21 cm, 8 1/4"	23 cm, 9"
MINI	41657-17	41657-21	41657-23
STANDARD	41658-17	41658-21	41658-23
MINI	41659-17	41659-21	41659-23
	drehbar / rotating / rotante / rotante		
STANDARD	41660-17	41660-21	41660-23
	drehbar / rotating / rotante / rotante		

Clips drehbar im Maul
 Clips rotabile in jaw
 Clips rotabile en la boca
 Clips rotabile nel morso

Anlegezange bayonett, mit Sperre
 Applying Forceps bayonett, with Ratchet
 Pinza de aplicación bayoneta, con cremallera
 Posa clips a baionetta con bloccaggio

Gefäßclips nach BIEMER
BIEMER Vessel Clips
Clips para vasos de BIEMER
Clips per vasi secondo BIEMER

	Maulöffnung Opening	Maullänge Length of jaws	Schließkraft Closing Force
 41661-40	Apertura de la boca Apertura del morso 4,0 mm	Largo de la boca Lunghezza del morso 6,0 mm	Fuerza del cierre Forza di chiusura 30 - 40 g (0,29 - 0,39 N)
 41661-50	5,0 mm	9,0 mm	30 - 40 g (0,29 - 0,39 N)
 41662-50	5,0 mm	9,0 mm	20 - 25 g (0,20 - 0,25 N)

für temporären Gebrauch

gekennzeichnet durch gelb eingefärbte Federenden
für Gefäße mit einem Durchmesser 0,5 - 2,0 mm

Maulinnenflächen schräg gerieft für schonendes,
sicheres Festhalten der Gefäße

Der fest eingestellte Schließdruck gewährt risikofreie
Anwendung

for temporary occlusion

(identified by yellow coloured spring ends) for vessel
diam. 0,5 - 2,0 mm

Blade gripping surface with oblique serrations for
save but careful gripping of vessels

No risk due to rigidly fixed pressure measure

para uso temporal

clips marcados con baño dorado en los resortes,
para vasos con un diámetro de 0,5 - 2,0 mm

El interior de las quijadas viene con estrías finas para
un agarre seguro y cuidadoso de los vasos

Debido a la calibración exacta de la fuerza de cierre
se ofrece una aplicación sin riesgo

per chiusura temporanea

per vasi con Diametro 0,5 - 2,0 mm

La chiusura regolata garantisce nessun rischio

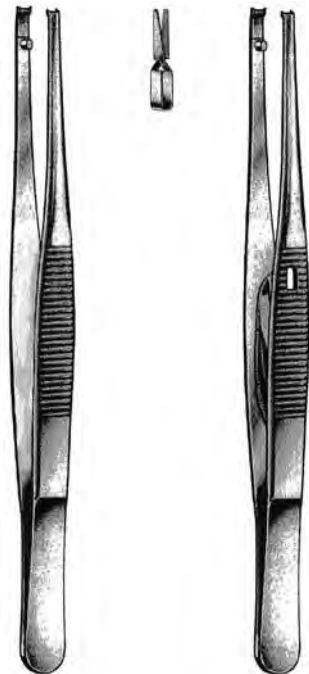

BIEMER
41663-01

Anlegepinzette ohne Schloß,
für Mikro-Gefäßclips
41661-40 - 41662-50
und
Approximatoren
41667-30 - 41670-50
und
41672-01 - 41672-04

Applying forceps without lock.
for vessel clips
41661-40 - 41662-50
and
Aproximators
41667-30 - 41670-50
and
41672-01 - 41672-04

BIEMER
41663-02

Anlegepinzette mit Schloß,
für Mikro-Gefäßclips
41661-40 - 41662-50
und
Approximatoren
41667-30 - 41670-50
und
41672-01 - 41672-04

Applying forceps with lock.
for vessel clips
41661-40 - 41662-50
and
Aproximators
41667-30 - 41670-50
and
41672-01 - 41672-04

Gefäßclips nach MEHDORN
MEHDORN Vessel Clips
Clips para vasos de MEHDORN
Clips secondo MEHDORN

für temporären Gebrauch

gekennzeichnet durch gelb eingefärbte Federenden für Gefäße mit einem Durchmesser 0,5 - 1,5 mm

Maulinnenflächen schräg gerieft für schonendes, sicheres Festhalten der Gefäße

Der fest eingestellte Schließdruck gewährt risikofreie Anwendung

for temporary occlusion

(identified by yellow coloured spring ends) for vessel diam. 0,5 - 1,5 mm

Blade gripping surface with oblique serrations for save but careful gripping of vessels

No risk due to rigidly fixed pressure measure

para uso temporal

clips marcados con baño dorado en los resortes, para vasos con un diámetro de 0.5 - 1.5 mm

El interior de las quijadas viene con estrias finas para un agarre seguro y cuidadoso de los vasos

Debido a la calibración exacta de la fuerza de cierre se ofrece una aplicación sin riesgo

per chiusura temporanea

per vasi con Diametro 0,5 - 1,5 mm

La chiusura regolata garantisce nessun rischio



Beispiele für die variable Position des Clips
Ejemplo para la variedad de la aplicación del clip
Esempio: posizioni variabili delle clips

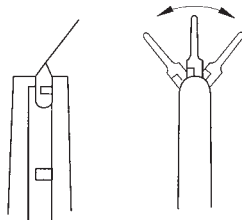

	Maullänge Length of jaws Largo de la boca Lunghezza del morso	Schließkraft Closing Force Fuerza del cierre Forza di chiusura	MEHDORN 41666-00
	41664-10 4 x 1,0 mm	10 - 15 g (0,10 - 0,15 N)	Anlegepinzette für Mikro-Gefäßclips 41664-10 - 41665-14
	41664-14 4 x 1,4 mm	15 - 20 g (0,15 - 0,20 N)	Applying Forceps for vessel clips 41664-10 - 41665-14
	41665-10 6 x 1,0 mm	10 - 15 g (0,10 - 0,15 N)	Pinza de aplicación para micro-clips 41664-10 - 41665-14
	41665-14 6 x 1,4 mm	15 - 20 g (0,15 - 0,20 N)	Pinza posa clips per microvasi 41664-10 - 41665-14

Approximatoren nach Biemer-Müller
 Approximators Biemer-Müller
 Aproximadores de Biemer-Müller
 Approssimatore secondo Biemer-Müller

für temporären Gebrauch

gekennzeichnet durch gelb eingefärbte Federenden für Gefäße mit einem Durchmesser 0,5 - 2,0 mm
 Maulinnenflächen schräg gerieft für schonendes, sicheres Festhalten der Gefäße
 Der fest eingestellte Schließdruck gewährt risikofreie Anwendung

for temporary occlusion

(identified by yellow coloured spring ends) for vessel diam. 0,5 - 2,0 mm
 Blade gripping surface with oblique serrations for save but careful gripping of vessels
 No risk due to rigidly fixed pressure measure

para uso temporal

clips marcados con baño dorado en los resortes, para vasos con un diámetro de 0,5 - 2,0 mm
 El interior de las quijadas viene con estrías finas para un agarre seguro y cuidadoso de los vasos
 Debido a la calibración exacta de la fuerza de cierre se ofrece una aplicación sin riesgo

per chiusura temporanea

per vasi con Diametro 0,5 - 2,0 mm
 La chiusura regolata garantisce nessun rischio

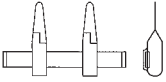
	Maulöffnung Opening	Maullänge Length of jaws	Schließkraft Closing Force
	Apertura de la boca Apertura del morso	Largo de la boca Lunghezza del morso	Fuerza del cierre Forza di chiusura
41667-30	3,0 mm	4,5 mm	30 - 40 g (0,29 - 0,39 N)

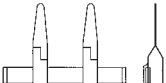
	5,0 mm	9,0 mm	30 - 40 g (0,29 - 0,39 N)
41667-50			

	5,0 mm	9,0 mm	30 - 40 g (0,20 - 0,25 N)
41668-50			

	5,0 mm	9,0 mm	30 - 40 g (0,20 - 0,25 N)
41669-50			

	5,0 mm	9,0 mm	30 - 40 g (0,20 - 0,25 N)
41670-50			

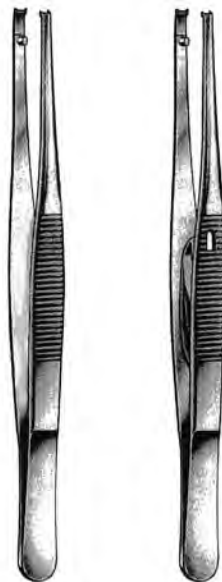

BIEMER
41663-01

BIEMER
41663-02

Anlegepinzette ohne Schloß,
für Mikro-Gefäßclips
41661-40 - 41662-50
und
Approximatoren
41667-30 - 41670-50
und
41672-01 - 41672-04

Anlegepinzette mit Schloß,
für Mikro-Gefäßclips
41661-40 - 41662-50
und
Approximatoren
41667-30 - 41670-50
und
41672-01 - 41672-04

Applying forceps without lock.
for vessel clips
41661-40 - 41662-50
and
Aproximators
41667-30 - 41670-50
and
41672-01 - 41672-04

Applying forceps with lock.
for vessel clips
41661-40 - 41662-50
and
Aproximators
41667-30 - 41670-50
and
41672-01 - 41672-04

Approximatoren nach Müller
 Müller Approximators
 Aproximadores de Müller
 Approssimatore secondo Müller

für temporären Gebrauch

gekennzeichnet durch gelb eingefärbte Federenden für Gefäße mit einem Durchmesser 0,5 - 2,0 mm
 Maulinnenflächen schräg gerieft für schonendes, sicheres Festhalten der Gefäße
 Der fest eingestellte Schließdruck gewährt risikofreie Anwendung

for temporary occlusion

(identified by yellow coloured spring ends) for vessel diam. 0,5 - 2,0 mm
 Blade gripping surface with oblique serrations for save but careful gripping of vessels
 No risk due to rigidly fixed pressure measure

para uso temporal

clips marcados con baño dorado en los resortes, para vasos con un diámetro de 0,5 - 2,0 mm
 El interior de las quijadas viene con estrias finas para un agarre seguro y cuidadoso de los vasos
 Debido a la calibración exacta de la fuerza de cierre se ofrece una aplicación sin riesgos

per chiusura temporanea

per vasi con Diametro 0,5 - 2,0 mm
 La chiusura regolata garantisce nessun rischio

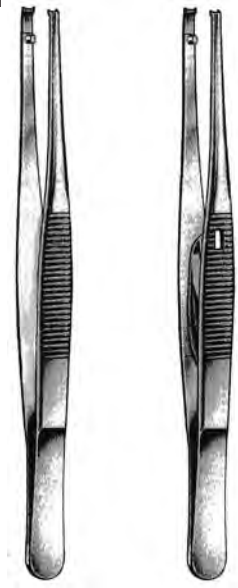

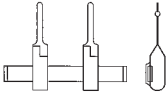
	Ø Diameter	Schließkraft Closing Force Fuerza del cierre Forza di chiusura
41672-01	1,0 mm	25 - 30 g (0,25 - 0,29 N)
41672-02	2,0 mm	25 - 30 g (0,25 - 0,29 N)
41672-03	3,0 mm	25 - 30 g (0,25 - 0,29 N)
41672-04	4,0 mm	25 - 30 g (0,25 - 0,29 N)

BIEMER
41663-01

BIEMER
41663-02

Anlegepinzette ohne
Schloß,
für Mikro-Gefäßclips
41661-40 - 41662-50
und
Approximatoren
41667-30 - 41670-50
und
41672-01 - 41672-04

Anlegepinzette mit
Schloß,
für Mikro-Gefäßclips
41661-40 - 41662-50
und
Approximatoren
41667-30 - 41670-50
und
41672-01 - 41672-04

Applying forceps without
lock.
for vessel clips
41661-40 - 41662-50
and
Aproximadores
41667-30 - 41670-50
and
41672-01 - 41672-04

Applying forceps with
lock.
for vessel clips
41661-40 - 41662-50
and
Aproximadores
41667-30 - 41670-50
and
41672-01 - 41672-04

Gefäßclips nach Müller
Müller Vessel Clips
Clips para vasos de Müller
Clip secondo Müller

für temporären Gebrauch

Maulinnenflächen pyramidenförmig für schonendes, sicheres Festhalten der Gefäße

Der fest eingestellte Schließdruck gewährt risikofreie Anwendung



41674-50 50 g

Schließkraft
Closing Force
Fuerza del cierre
Forza di chiusura

for temporary occlusion

Blade gripping surface with pyramid-like impressions for save but careful gripping of vessels

No risk due to rigidly fixed pressure measure

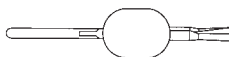

41674-80 80 g

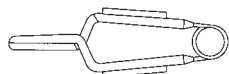

41675-50 50 g

para uso temporal

El interior de las quijadas viene en forma de pirámide para un agarre seguro y cuidadoso de los vasos.

Debido a la calibración exacta de la fuerza de cierre se ofrece una aplicación sin riesgo.



41675-80 80 g

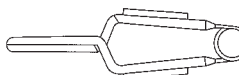

41676-50 50 g

per uso temporaneo

Morso interno con forma piramidale per garantire una chiusura sicura del vaso



41676-80 80 g



41677-50 50 g

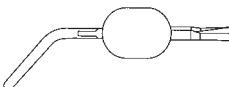

41677-80 80 g

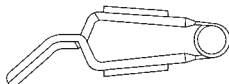

41678-50 50 g



41678-80 80 g

Approximator nach Biemer
 Biemer Approximator
 Aproximadores de Biemer
 Approssimatore secondo Biemer

für Mikro-Gefäßanastomosen im oberflächlichem Bereich

Maulinnenflächen schräg gerieft für schonendes, sicheres Festhalten der Gefäße

Der fest eingestellte Schließdruck gewährt risikofreie Anwendung

Der Abstand zwischen den Clips ist durch einfaches Verschieben einzustellen und wird durch Verkanten fixiert

for micro vessel anastomosis in the superficial range

Blade gripping surface with oblique serrations for save but careful gripping of vessels

No risk due to rigidly fixed pressure measure

Adjustable distance between the clips and automatic fixation by tilting

para micro-anastomosis en la superficie

El interior de la quijada viene con estrias finas para un agarre seguro y cuidadoso de los vasos.

Debido a la calibración exacta de la fuerza de cierre se ofrece una aplicación sin riesgo.

El espacio entre los clips se logra fácilmente por el desplazamiento.

per micro vasi anastomosi sulla parte della superficie

Parte interna del morso è leggermente striata obliqua per ottenere la presa sulla superficie del vaso.

La chiusura regolata garantisce nessun rischio.

Lo scorrimento delle due clips viene regolato con semplice movimento che consente una chiusura ottimale.

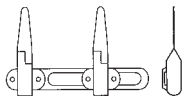

41679-25

Schließkraft
 Closing Force
 Fuerza de cierre
 Forza di chiusura

25 - 30 g
 (0,25 - 0,29 N)



BIEMER
 41680-00

Anlegepinzette für Gefäß-
 Approximator nach BIEMER

Applying forceps for BIEMER
 vessel approximator

Pinza de aplicación para
 aproximadores de BIEMER

Pinza posa clips per vasi
 approssimatori secondo
 BIEMER

LEYLE Retraktor System
 LEYLE Retractor System
 Separador de sistema LEYLE
 LEYLE Sistema di fissaggio

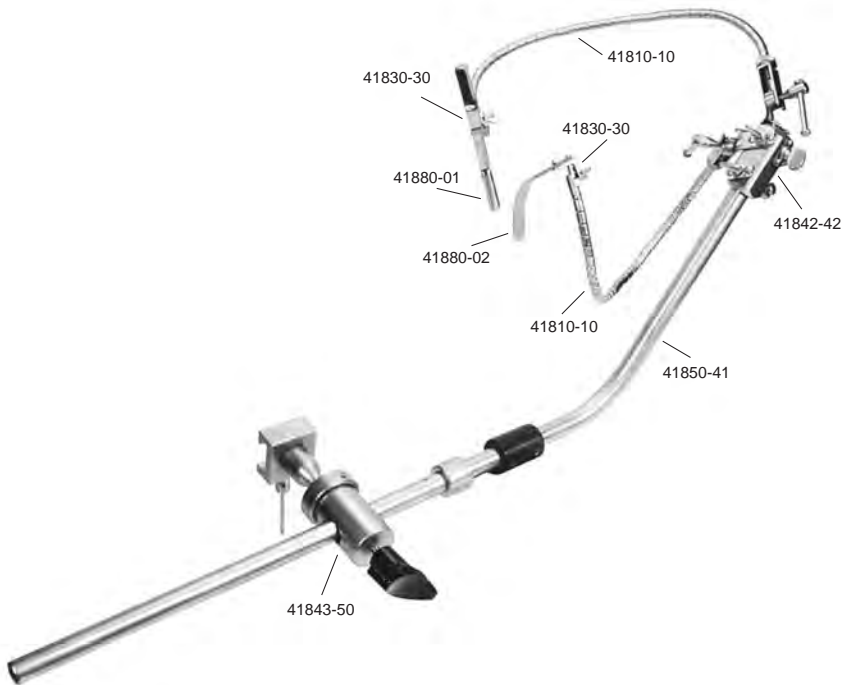

- 41802-00 LEYLE-Retraktor-System zum Fixieren am OP-Tisch komplett, bestehend aus:
 LEYLE Self-Retraining Retractor for fixation to operating table, complete, consisting of:
 Separador LEYLE para fijación a la mesa de operaciones, completo, compuesto de:
 LEYLE Sistema di fissaggio al tavolo operatorio, composto da:
- | | | | |
|----------|--|----------|---|
| 41843-50 | Kugelgelenkkloben (1x)
ball and socket joint (1x)
articulación esférica (1x)
giunto per fissare (1x) | 41830-30 | Spatelhalter für flache Spatel (2x)
support for flat brain spatula (2x)
soporte para espátulas cerebrales planas (2x)
sostegno per spatole piatte (2x) |
| 41850-41 | starrer Haltearm (1x)
rigid holding rod (1x)
brazo de fijación rígido (1x)
braccio di fissaggio rigido (1x) | 41880-01 | CUSHING Hirnspatel (1x)
CUSHING brain spatula (1x)
CUSHING espátula para cerebro (1x)
CUSHING spatola cerebrale (1x) |
| 41842-42 | Kupplungskopf (1x)
coupling head (1x)
cabeza de acoplamiento (1x)
giunto per combinare (1x) | 41880-02 | CUSHING Hirnspatel (1x)
CUSHING brain spatula (1x)
CUSHING espátula para cerebro (1x)
CUSHING spatola cerebrale (1x) |
| 41810-10 | flexibler Spannarm (2x)
flexible arm, only (2x)
brazo flexible, suelto (2x)
braccio flessibile, solo (2x) | | |

LEYLA Retraktor System
 LEYLA Retractor System
 Separador de sistema LEYLA
 LEYLA Sistema di fissaggio



- 41843-50** Kugelgelenkkloben
 zum Befestigen an der OP-Tischschiene und zur Aufnahme
 des Haltearms 41850-41
 ball and socket joint
 for fixation of holding rod 41850-41 at the operating table
 articulation estérica, para sujetar el brazo de soporte rígido
 sobre la mesa de operaciones 9 x 32 mm
 giunto per fissare il braccio, articolato 9 x 32 mm



- 41850-41** starrer Haltearm, auseinandernehmbar, zur Fixation im
 Kugelgelenkkloben 41843-50 und zur wahlweisen
 Aufnahme der Kupplungsköpfe 41842-42, 41842-44
 und 41842-46
 holding rod, detachable, for fixation in ball and socket joint
 41843-50 and to hold a desired coupling head
 41842-42, 41842-44 or 41842-46
 brazo de soporte rígido, desmontable, para fijación a la
 articulación estérica 41843-50 y opcionalmente a las
 cabezas 41842-42, 41842-44 y 41842-46
 braccio di sostegno rigido, per fissaggio al giunto 41843-50
 e dei giunti 41842-42, 41842-44 e 41842-46



- 41842-42** Kupplungskopf, zur Aufnahme von max. 5 flexiblen
 Spannarmen 41810-10
 coupling head to hold 5 flexible arms 41810-10
 cabeza de acoplamiento para fijar hasta 5 brazos flexibles
 giunto per combinare 5 bracci



- 41842-44** Kupplungskopf, drehbar, zur Aufnahme von 1 flexiblen
 Spannarm 41810-10
 coupling head, turnable, to hold 1 flexible arm 41810-10
 acoplamiento, girable y se puede fijar en todas las posturas
 para sujetar un brazo flexible 41810-10
 giunto per combinare, rotabile, per sostegno del braccio
 41810-10
41842-46 Kupplungskopf, seitlich offen zur Aufnahme von 1 flexiblen
 Spannarm 41810-10
 coupling head, lateral open, to hold 1 flexible arm 41810-10
 acoplamiento, abierto al lado, para un brazo flexible
 41810-10
 giunto per fissare il braccio, per 41810-10

LEYLA Retraktor System
 LEYLA Retractor System
 Separador de sistema LEYLA
 LEYLA Sistema di fissaggio



41801-01 Hirnspatelhalter, flexibel, für 1 flachen Spatel, komplett, bestehend aus:
 brain retractor, flexible, for 1 flat spatula, complete, consisting out of:
 separador autorententivo, flexible, para espátula con 1 brazo flexible,
 completo, compuesto de:
 divaricatore autostatico, flessibile, per spatole piatte, con 1 braccio flessibile, completo, composto da:

41810-10 flexibler Spannarm
 flexible arm, only
 brazo flexible, suelto
 braccio flessibile, solo

41826-26 Fixiervorrichtung für 1 flexiblen Spannarm
 fixation Base for 1 flexible arm
 fijador para 1 brazo flexible
 fissatore per 1 braccio al braccio rigido

41830-30 Spatelhalter für flache Spatel
 support for flat brain spatula
 soporte para espátulas cerebrales planas
 sostegno per spatole piatte



41802-02 Hirnspatelhalter, flexibel für 2 flache Spatel, komplett, bestehend aus:
 brain retractor, flexible, for 2 flat spatulas, complete, consisting out of:
 separador autorententivo, flexible, para 2 espátulas planas con 2 brazos flexibles, completo, compuesto de:
 divaricatore autostatico, flessibile, per spatole piatte, con 2 bracci flessibili, completo, composto da:

41810-10 flexibler Spannarm (2x)
 flexible arm, only (2x)
 brazo flexible, suelto (2x)
 braccio flessibile, solo (2x)

41822-22 Fixiervorrichtung für 2 flexible Spannarme
 fixation Base for 2 flexible arms
 fijador para 2 brazos al cráneo
 fissatore per 2 bracci al cranio

41830-30 Spatelhalter für flache Spatel (2x)
 support for flat brain spatula (2x)
 soporte para espátulas cerebrales planas (2x)
 sostegno per spatole piatte (2x)

LEYLA Retraktor System
 LEYLA Retractor System
 Separador de sistema LEYLA
 LEYLA Sistema di fissaggio



YASARGIL
41810-10

- 41810-10 flexibler Spannarm
 flexible arm, only
 brazo flexible, suelto
 braccio flessibile, solo

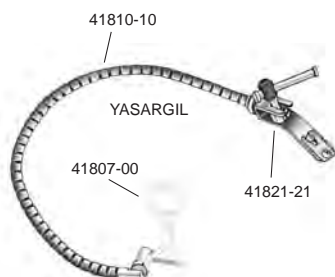

41810-10

YASARGIL

41807-00

41821-21

- 41803-01 Ohrspekulahalter, komplett, bestehend aus:
 ear specula holder, complete, consisting out of:
 soporte para especulos auriculares completo, compuesto de:
 sostegno per specolo auricolare, completo composto da:
- 41810-10 flexibler Spannarm
 flexible arm, only
 brazo flexible, suelto
 braccio flessibile, solo
- 41821-21 Fixiervorrichtung zum Befestigen an Rohrteilen bis Ø 16 mm
 clamp for fixation on bars up to Ø 16 mm
 fijador para 1 brazo flexible, para atornillar a tubos hasta 16 mm
 fissatore al braccio rigido Ø 16 mm
- 41807-00 Ohrtrichterhalter, allein
 ear specula holder, only
 soporte para especulos auriculares, suelto
 sostegno per specolo auricolare

LEYLA Retraktor System
 LEYLA Retractor System
 Separador de sistema LEYLA
 LEYLA Sistema di fissaggio

41821-21

Fixiervorrichtung an Rohrteilen bis \varnothing 16 mm, für 1 flexiblen Spannarm
 Fixation base for mounting on bars up to \varnothing 16 mm, for 1 flexible arm
 Fijador para 1 brazo flexible, para atornillar a tubos hasta 16 mm
 Fissatore per 1 braccio al braccio rigido



41822-22

Fixiervorrichtung am Schädel für 2 flexible Spannarme
 Fixation Base for skull mounting, holding 2 flexible arms
 Fijador para 2 brazos al cráneo
 Fissatore per 2 bracci al cranio



41826-26

Fixiervorrichtung am Schädel für 1 flexiblen Spannarm
 Fixation Base for skull mounting, holding 1 flexible arm
 Fijador para 1 brazo al cráneo
 Fissatore per 1 braccio al cranio



41830-30

Halter für flache Hirnspateln
 Support for flat brain spatula
 Soporte para espátulas cerebrales planas
 Sostegno per spatole piatte



41832-32

Halter für Hirnspateln mit rundem Schaft
 Support for brain spatula with round shaft
 Soporte para espátulas cerebrales con mango redondo
 Sostegno per spatola cerebrale



Hirnspatel
Brain Spatulas
Espátula Cerebral
Spatole Cerebrali



HEIFETZ
200 mm
8"

	Breite width ancho larghezza	Gesamtlänge total length largo total lunghezza totale
41860-14	14 mm	200 mm
41860-17	17 mm	200 mm
41860-20	20 mm	200 mm
		biegsam malleable maleabile malleabili



HEIFETZ
155 mm
6"

	Breite width ancho larghezza	Gesamtlänge total length largo total lunghezza totale
41870-08	8 mm	155 mm
41870-11	11 mm	155 mm
41870-14	14 mm	155 mm
41870-17	17 mm	155 mm
		biegsam malleable maleabile malleabili

	Breite width ancho larghezza	Gesamtlänge total length largo total lunghezza totale
41880-01	9 mm	200 mm
41880-02	12 mm	200 mm
41880-03	12 mm	250 mm
		biegsam malleable maleabile malleabili



CUSHING
200 mm, 8"

Lidsperrer
 Eye Specula
 Blefaróstatos
 Blefarostati

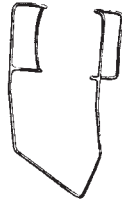

BARRAQUER (Colibri)

43101-03 3 cm, 1.2" für Kinder / children / niños / bambini
 43101-04 4 cm, 1.6" für Erwachsene / adults / adultos / adulti



BOWMAN

43104-07
 7 cm, 2 3/4"

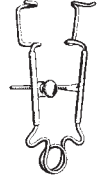

CRITCHETT

43105-06
 7 cm, 2 3/4"



SMITH
 43106-05
 5 cm, 2"



CLARK
 43107-08
 8 cm, 3 1/8"



GRAEFE
 43109-07 7 cm, 2 3/4"
 43109-09 9 cm, 3 1/2"



WEEK
 43108-08
 8 cm, 3 1/8"

rechts
 right
 a la derecha
 destro

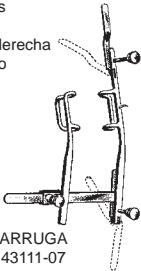

ARRUGA
 43111-07
 7 cm, 2 3/4"

links
 left
 a la izquierda
 sinistro

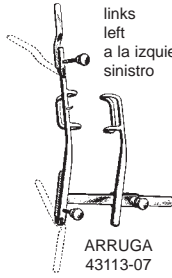

ARRUGA
 43113-07
 7 cm, 2 3/4"

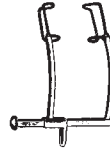

MURDOCK
 43115-05
 5 cm, 2"

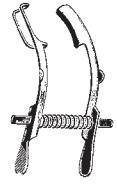

MELLINGER-AXENFELD
 43121-07
 7 cm, 2 3/4"

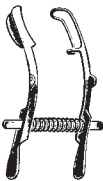

MELLINGER-AXENFELD
 43123-07
 7 cm, 2 3/4"

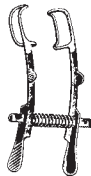

MELLINGER
 43125-05 5 cm, 2"
 43125-07 7 cm, 2 3/4"



LISTER-BURCH
 43127-08
 8 cm, 3 1/8"



WILLIAMS
 43128-08
 8 cm, 3 1/8"

Lidsperrer, Lidplatte, Starmesser
 Eye Specula, Lid Plate, Cataract Knives
 Blefaróstatos, Placa para párpados, cuchillos para cataratas
 Blefarostati, Placca per palpebre, coltelli per cataratta



LANCASTER
 43129-07
 7 cm, 2 3/4"



ZIEGLER
 43130-07
 7 cm, 2 3/4"



CASTROVIEJO
 43132-08
 8 cm, 3 1/8"

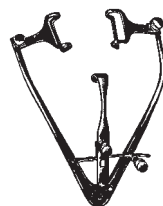

PARK
 43133-08
 8 cm, 3 1/8"



MUELLER
 43135-07
 7 cm, 2 3/4"



STEVENSON
 43139-07
 7 cm, 2 3/4"



LIEBERMAN
 43140-08
 8 cm 3 1/8"



LIEBERMAN
 43141-08
 8 cm 3 1/8"



JAEGER
 43150-11
 11 cm, 4 3/8"



GRAEFE
 43170-00 - 43170-03
 13 cm, 5 1/8"



43170-00



43170-01



43170-02



43170-03



DEUTSCHMANN
 43172-13
 13 cm, 5 1/8"

Lanzenmesser, Diszisionsmesser, Irismesser, Diszisionsmesser
 Cataract knife, keratome, Iris knife, discision knife
 Cuchillos lanceolares y Cuchillos de discisión
 Cheratom, bisturi p. capsule, bisturi corneale



43180-01 - 43181-03

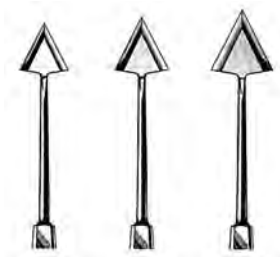

JAEGER
 43180-01 Fig. 1 13 cm, 5 1/8"
 43180-02 Fig. 2 13 cm, 5 1/8"
 43180-03 Fig. 3 13 cm, 5 1/8"



JAEGER 45°
 43181-01 Fig. 1
 43181-02 Fig. 2
 43181-03 Fig. 3



BERENS
 43183-13
 13 cm, 5 1/8"



CASTROVIEJO
 43185-13 13 cm
 4 x 13 mm



GRAEFE
 43187-13
 13 cm, 5 1/8"



KNAPP
 43202-01 Fig. 1
 13 cm, 5 1/8"



KNAPP
 43202-02 Fig. 2
 13 cm, 5 1/8"



KNAPP
 43202-03 Fig. 3
 13 cm, 5 1/8"



ZIEGLER
 43210-01 5 mm
 Fig. 1
 13 cm, 5 1/8"



ZIEGLER
 43210-02 6 mm
 Fig. 2
 13 cm, 5 1/8"



ZIEGLER
 43210-03 7 mm
 Fig. 3
 13 cm, 5 1/8"



DEAN
 43213-12
 12,5 cm, 5"



BOWMAN
 43214-04 13 cm
 0,4 mm
 13 cm, 5 1/8"



BOWMAN
 43214-08 13 cm
 0,8 mm
 13 cm, 5 1/8"

Hornhautmesser, Hornhautschaber, Dissektor, Sklerotom, Goniotomiemesser
 Corneal Scarifier, -dissector, sclerotome, goniotomy knife
 Cuchillos para cornea, legtras corneales, esclerótomos
 Spatole p. corneale, dissettore corneale, sclerotomo, coltello per goniotomia



WHEELER
43218-12
12 cm, 4 3/4"



ZIEGLER
43221-11
11 cm, 4 3/8"
3,5 mm



SATO
43226-12
12,5 cm, 5"



TOOK
43228-12
12 cm, 4 3/4"



GILL
43231-12
12 cm, 4 3/4"



ELSCHMIG
43233-13
13 cm, 5 1/8"



KUHNT
43240-01
Fig. 1



KUHNT
43240-02
Fig. 2



KUHNT
43240-03
Fig. 3



KUHNT
43240-04
Fig. 4



PATON
43245-12
12 cm, 4 3/4"



LUNDSGAARD
43251-12
12 cm, 4 3/4"



GUYTON-
LUNDSGAARD
43253-12



BARKAN
43256-12



SCHEIE
43258-12



BURCH
43262-12



PAUFIQUE
43271-11



BARRAQUER
43273-13

Disziisionsnadeln, Fremdkörpernadeln, Fremdkörperhohlmeißel
 Discision Needles, Foreign-Body Instruments
 Aguja de discisión, Instrumental para cuerpos extraños
 Aghi per discisione, strumenti per corpi estranei



43304-12



43305-12



BOWMAN
43308-12



BOWMAN
43309-12



43310-13



43311-13



LEVINSON
43314-13



FRANCIS
43321-12



DAVIS
43325-13



LA FORCE
43327-12



DIX
43330-13



ELLIS
43331-11



WALTON
43332-12
1,4 mm



WALTON
43334-12
1,4 mm



ALVIS
43336-12

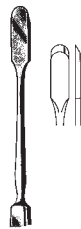

GREEN
43340-13



ROLLET
43342-12

Schielhaken, Tenotomiehaken, Extraktionshaken, Tränensackhäkchen
 Strabismus hook, lens hook, extraction hook
 Ganchos para estrabismo, - cristalino, extracción
 Uncino per il strabismo, uncino p. cristallino, protettori, uncini per l'iride



Fig. 1
 GRAEFE
 43351-01
 13 cm, 5 1/8"



Fig. 2
 GRAEFE
 43351-02
 14 cm, 5 1/2"



Fig. 3
 GRAEFE
 43351-03
 15 cm, 6"



JAMESON
 43353-13



GREEN
 43355-13



STEVENS
 43357-13



Fig. 1
 ARRUGA
 43363-01



Fig. 2
 ARRUGA
 43363-02



O'CONNOR
 43370-12



WIENER
 43372-13



WIENER
 43373-13



ROLLET
 43376-13



KNAPP
 43377-13



GRAEFE
 43380-13



GRAEFE
 43381-13



GRAEFE
 43383-13



BECKER
 43386-13

Implantations Instrumente
 Instruments for Implantation
 Instrumentos para implantación
 Strumenti per impianto

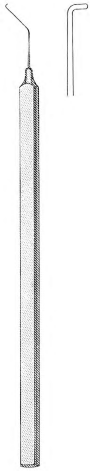

CLAYMAN
 43387-02
 11,5 cm 4 1/2"



SINSKEY
 43388-02
 11,4 cm 4 1/2"



SINSKEY
 43389-02
 12 cm 4 3/4"

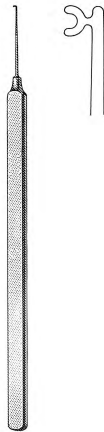

KUGLEN
 43390-05
 11,7 cm 4 5/8"



GASS
 43391-13
 14,6 cm 5 3/4"

Küretten und Löffel für Chalazion und Star
 Scoops and Curettes for Chalazío, Cataract, and Exenteration
 Curetas y cucharillas para chalazío, catarata y exenteraci3n
 Curette e cucchiai per calazio, cateratta e palpebre

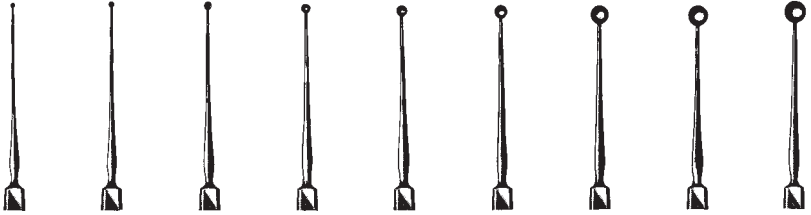

MEYHOEFER

	43402-05	43402-10	43402-15	43402-18	43402-20	43402-25	43402-35	43402-40	43402-45
Ø mm	0,5	1,0	1,5	1,8	2,0	2,5	3,5	4,0	4,5



	HEBRA	HEBRA	HEBRA	HEBRA	HEBRA
	43404-10	43404-20	43404-24	43404-30	43404-35
Ø mm	1,0	2,0	2,5	3,0	3,5



AXENFELD
43407-13



GRAEFE
43410-01



GRAEFE
43410-02



DAVIEL
43412-01
3 mm



DAVIEL
43412-02
4 mm

Starlöffel, Exenterationslöffel, Drahtschlingen, Starschlingen, Irisspatel, E nukleationslöffel, Wundlöffel
 Cataract Spoon, Exenteration Scoops, Lens Scoops, Spatulas, Protectores
 Cucharillas para Catarata-, exenteración, Asas, Espátulas, Protectores
 Cucchiaino per cataratta- esenterazione, Anse, Spatole, Protettori



KNAPP
43414-02



BUNGE
43420-01



BUNGE
43420-02



BUNGE
43420-03



LANG
43424-13



WEBER
43441-01 Fig. 1



43441-02
Fig. 2



SNELLEN
43443-13



WILDER
43445-13 Fig. 1



43447-13
Fig. 2



ARLT



43449-01



43449-02

Cautery
Cauter
Cauterio

Iris
Iride



WECKER
43461-13



WECKER
43462-13



CULLER
43467-13



WELLS
43482-20



ARRUGA
43485-13



WADSWORTH-TODD
43487-14

Zyklodialysespatel, Fremdkörperinstrumente
 Cyclodialysis Spatula, Foreign Body Instruments
 Espátulas para ciclodialísis, Instrumentos para cuerpos extraños
 Spatole per ciclodialisi, Strumenti per corpi estranei

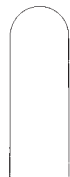

BANGERTER

43501-06
6 mm43501-10
10 mm43501-12
12 mm

43511-13 - 43517-09

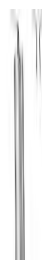
CASTROVIEJO
43511-13
1,2 x 10 mmCASTROVIEJO
43513-14
1,5 x 15 mmELSCHNIG
43515-14
1,2 x 12 mmCASTROVIEJO
43517-09
0,8 x 15 mmCASTROVIEJO
43521-12
12 cm, 4 3/4"WHEELER
43523-12
12 cm, 4 3/4"HIRSCHMAN
43524-10
12,5 cm, 5"CASTROVIEJO
43525-05 0,50 mm
43525-07 0,75 mm
43525-10 1,00 mmBECHERT
43526-12
12,5 cm, 5"

Fremdkörperinstrumente, Meßzirkel, Kapselstanze
 Foreign- Body Instruments, Markers, Corneoscleral punch
 Instrumental para cuerpos extraños, Compás de la cápsula, Pinza para capsuloiroidectom
 Strumenti per corpi estranei, Marcatori, Pinza per capsula



DIX
43542-12



DIX
43544-12



DIX
43546-13



DIX
43548-13



CASTROVIEJO
43583-07 0-20 mm
7 cm, 2 3/4"



CONNIN-AMSLER
43589-13



HOLTH
43593-09

Tränenkanaldilatatoren, Sonden
Lachrymal Dilators-, Probes
Dilatadores, Estiletos para canal lacrimal
Dilatatori e Specilli per canale lacrimale



WILDER
43602-01



WILDER
43602-02



WILDER
43602-03



Fig. ZIEGLER
1/2 43605-12
3/4 43605-34
5/6 43605-56



CASTROVIEJO
43608-12

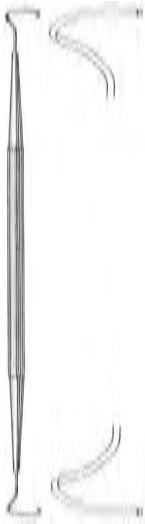

WORST
43609-14
14,9 cm 5 7/8"

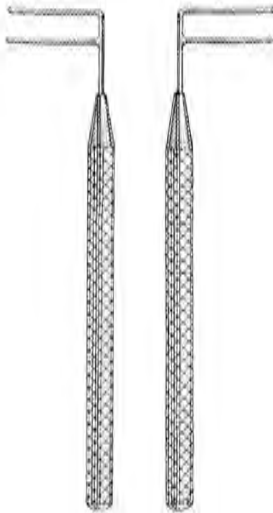

HARMS
43610-01 43610-02
4,8 cm 1 7/8"

geknöpft



rostfrei
stainless steel
acero inoxidable
acciaio inossidabile

Fig.	BOWMAN	Ø mm
0000/000	43613-00	0,6/0,7
00/0	43614-00	0,7/0,8
0/1	43614-01	0,8/0,9
1/2	43614-12	0,9/1,1
2/3	43614-23	1,1/1,3
3/4	43614-34	1,3/1,4
4/5	43614-45	1,4/1,5
5/6	43614-56	1,5/1,6
6/7	43614-67	1,6/1,8
7/8	43614-78	1,8/1,9

Iris Pinzetten
 Iris Forceps
 Pinzas para iris
 Pinze per iride



GRAEFE
 43802-07
 7 cm (2 3/4")/1 mm

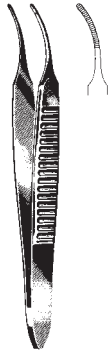

GRAEFE
 43803-07
 7 cm (2 3/4")/1 mm



GRAEFE
 43804-07
 7 cm (2 3/4")/1 mm

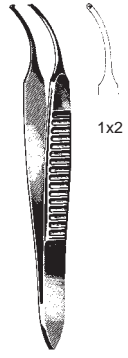

GRAEFE
 43805-07
 7 cm (2 3/4")/1 mm



GRAEFE
 43810-10
 10 cm
 4"



GRAEFE
 43811-10
 10 cm
 4"



GRAEFE
 43813-10
 10 cm
 4"



GRAEFE
 43820-10
 10 cm
 4"



GRAEFE
 43821-10
 10 cm
 4"

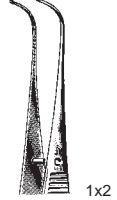

GRAEFE
 43823-10
 10 cm
 4"

Iris Pinzetten
 Iris Forceps
 Pinzas para iris
 Pinze per iride



STEVENS
 43830-10
 10,5 cm, 4.1"



STEVENS
 43831-10
 10,5 cm
 4.1"



STEVENS
 43833-10
 10,5 cm
 4.1"



STEVENS
 43840-10
 10,5 cm
 4.1"



STEVENS
 43841-10
 10,5 cm
 4.1"



STEVENS
 43843-10
 10,5 cm
 4.1"



FOERSTER
 43850-08
 8,5 cm, 3.4"



FOERSTER
 43851-08
 8,5 cm, 3.4"

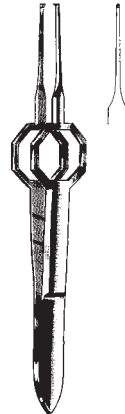

FOERSTER
 43852-08
 8,5 cm, 3.4"

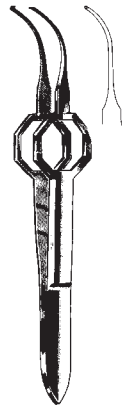

FOERSTER
 43853-08
 8,5 cm, 3.4"

Iris Pinzetten
 Iris Forceps
 Pinzas para iris
 Pinze per iride

seitliche Zähne
 lateral teeth
 dientes laterales
 denti laterali

Zähne abwärts
 teeth below
 dientes abajo
 denti in basso



HESS
 43855-07
 7 cm (2 3/4")/
 0,3 mm



HESS
 43857-07
 7 cm (2 3/4")/
 0,3 mm



GILL
 43861-07
 7,5 cm (3")/
 0,3 mm



GILL-HESS
 43863-07
 7,5 cm (3")/
 0,3 mm



GILL-HESS
 43865-07
 7,5 cm (3")/
 0,3 mm

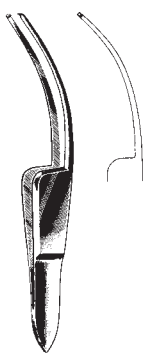

FISCHER
 43869-07
 7 cm (2 3/4")



BARRAQUER-KATZIN
 43881-07
 7 cm (2 3/4")/0,4 mm



TROUTMAN (Colibri)
 43883-07
 7 cm (2 3/4")/0,12 mm



BARRAQUER (Colibri)
 43885-07
 7 cm (2 3/4")/0,12 mm



BARRAQUER (Colibri)
 43887-07
 7 cm (2 3/4")/0,12 mm

Fixierpinzette, Strabismus-Pinzetten
 Fixation forceps, Strabismus-Forceps
 Pinza para fijación, Pinzas para estrabismo
 Pinza per fissatrice, Pinze per strabismo



1x2
 KIRBY-ARTHUR
 43891-09 9 cm, 3 1/2"
 0,2 mm



McCULLOUGH
 43902-09
 9,5 cm, 3 3/4"



McCULLOUGH
 43903-09
 9,5 cm, 3 3/4"

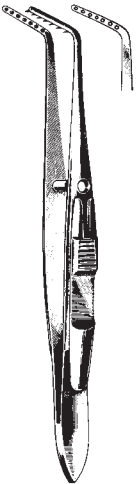

JAMESON
 43907-10
 L, 10 cm, 4"

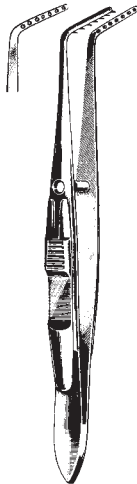

JAMESON
 43909-10
 R, 10 cm, 4"



BONACCOLTO
 43914-10
 10 cm, 4 1/1,7 mm



BONACCOLTO
 43916-10
 10 cm, 4 1/1,2 mm



BONACCOLTO
 43920-11
 11 cm, 4 3/8"

Strabismus-Pinzetten, Iris Pinzetten
 Strabismus-Forceps, Iris Forceps
 Pinzas para estrabismo, Pinzas para iris
 Pinze per strabismo, Pinze per iride



DASTOOR
 43924-11
 11 cm, 4 3/8"



DASTOOR
 43926-11
 11 cm, 4 3/8"



BISHOP-HARMAN
 43940-05 8,5 cm, 3.4"
 0,5 mm



BISHOP-HARMAN
 43940-08 8,5 cm, 3.4"
 0,8 mm



BISHOP-HARMAN
 43942-05 8,5 cm, 3.4"
 0,5 mm

1x2



BISHOP-HARMAN
 43942-08 8,5 cm, 3.4"
 0,8 mm

1x2

Iris Pinzetten, Nahtpinzetten, Muskelpinzetten
 Iris, Suture forceps, Muscle Forceps
 Pinzas para iris, Pinza para sutura, Pinzas musculares
 Pinze per iride, Pinza per sutura, muscolari

mit Führungsstift
 with guide pin
 con perno guida
 con perno di guida

ohne Führungsstift
 without guide pin
 sin perno guida
 senza perno di guida

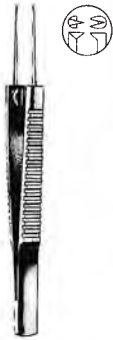

MOD. BONN
 43944-07
 7 cm, 2 3/4"
 0,12 mm



MOD. BONN
 43946-07
 7 cm, 2 3/4"
 0,12 mm



MOD. BONN
 43948-10
 10 cm, 4"
 0,12 mm



MOD. TÜBINGEN
 43950-10
 10 cm, 4"



MOD. BONN
 43952-10
 10 cm, 4 1/2", 0,12 mm



MOD. TÜBINGEN
 43953-10
 10 cm, 4"

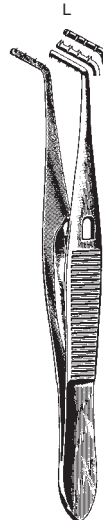

PRINCE
 43955-10
 10 cm, 4"

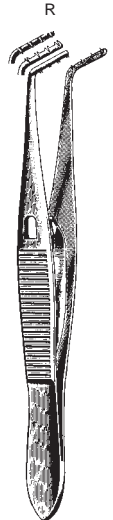

PRINCE
 43956-10
 10 cm, 4"

Muskelpinzetten, Fixationspinzetten
 Muscule Forceps, Fixation Forceps
 Pinzas musculares, Pinzas para fijación
 Pinze muscolari, Pinze per fissaggio

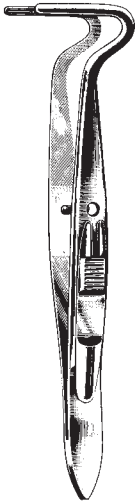

BERKE
 44015-20 - 44015-27
 10 cm, 4"

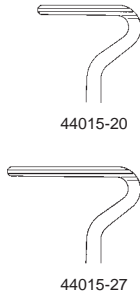

1x2
 TROUTMAN
 44017-08 8,5 cm, 3.4"
 0,8 mm



ELSCHMIG
 44046-11
 11 cm, 4 3/8"



GRAEFE
 44050-11 - 44052-11
 11 cm, 4 3/8"



44050-11



44052-11
 mit Sperre
 with catch
 con cierre
 c. cremagliera



LESTER
 44054-09
 9 cm, 3 1/2"

Fixierpinzetten, Kapselpinzette
 Fixation forceps, capsular forceps
 Pinzas para fijación, Pinzas capsulares
 Pinze fissatrici, Pinze per capsulari



1x1

CASTROVIEJO
 44066-09
 9 cm, 3 1/2"



1x1

CASTROVIEJO
 44067-09
 9 cm, 3 1/2"



2x2

CASTROVIEJO
 44068-09
 9 cm, 3 1/2"



2x2

CASTROVIEJO
 44069-09
 9 cm, 3 1/2"



BARRAQUER
 44074-10
 10 cm, 4"

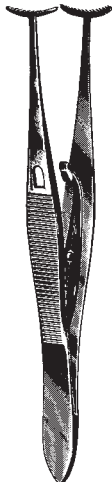

GREEN
 44076-05 - 44078-10
 10 cm, 4"



44076-05
 5 mm



44076-10
 10 mm

ohne Sperre
 without catch
 sin cierre
 senza cremagliera



44078-05
 5 mm



44078-10
 10 mm

mit Sperre
 with catch
 con cierre
 con cremagliera



GILL-ARRUGA
 44101-07
 7,5 cm, 3"

Kapselpinzetten
Capsular Forceps
Pinzas capsulares
Pinze capsulare



TERSON
44103-09
9 cm, 3 1/2"



KALT
44106-10
10 cm, 4"



ELSCHNIG
44109-10
10 cm, 4"



ARRUGA
44111-10
10 cm, 4"



ARRUGA
44114-10
10 cm, 4"



CASTROVIEJO
44115-10
10 cm, 4"



SCHWEIGGER
44117-10
10 cm, 4"



SCHWEIGGER
44119-10
10 cm, 4"



ELSCHNIG
44121-10
10 cm, 4"



HESS
44125-06
6 cm, 2.4"

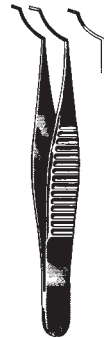

HESS
44127-06
6,5 cm, 2.6"



FUCHS
44129-07
7 cm, 2 1/4"

Nahtpinzetten, Fadenpinzetten
 Suture Forceps, Tying Forceps
 Pinzas para suturas y hilo
 Pinze per sutura, Pinze per filo



CASTROVIEJO
 10 cm, 4"
 44150-01 0,12 mm
 44150-03 0,30 mm
 44150-05 0,50 mm
 44150-10 1,00 mm
 44150-15 1,50 mm

Zahn
 tooth
 diente
 dente



CASTROVIEJO
 10 cm, 4"
 44151-05
 44151-10
 44151-15



MOORFIELD
 44164-10
 10 cm, 4"

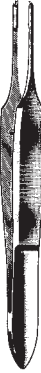

St. MARTIN
 44166-07
 7 cm, 2 3/4"



Mod. TÜBINGEN
 44181-10
 10 cm, 4"



PAUFIQUE
 44190-08
 8,5 cm, 3,4"



PAUFIQUE
 44202-08
 8,5 cm, 3,4"

1x2



McPHERSON
 44210-10
 10 cm, 4"



McPHERSON
 44220-10
 10 cm, 4"

Pinzetten für Chalazion und Trachom
 Forceps for Chalazion and Trachoma
 Pinzas de chalazión y para tracoma
 Pinze per calazio e per trichiasi



AYER
 44240-09
 9 cm, 3 1/2"

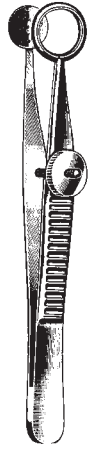

AYER
 44242-09
 9 cm, 3 1/2"



LAMBERT
 44246-09
 9 cm, 3 1/2"

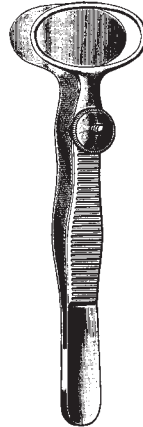

DESMARRES
 44254-09 - 44258-09
 9 cm, 3 1/2"



44254-09 20 mm
 Fig. 1



44256-09 24 mm
 Fig. 2

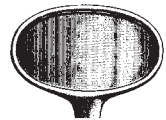

44258-09 32 mm
 Fig. 3

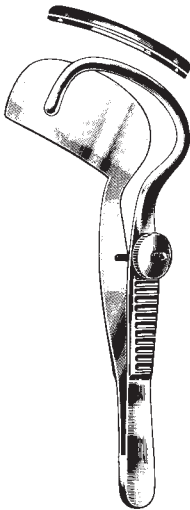

SNELLEN
 44265-10 10 cm, 4"

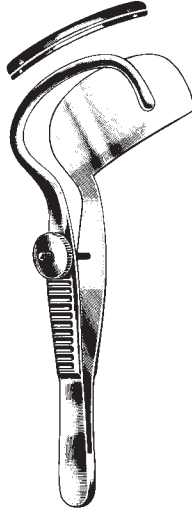

SNELLEN
 44267-10 10 cm, 4"

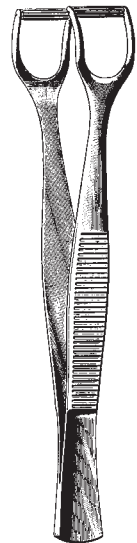

KNAPP-LUER
 44274-11 11 cm, 4 3/8"

Augenkanülen
Eye Cannulas
Cánulas oculares
Cannule oculistiche

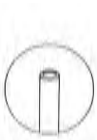

LACRIMAL
44300-00
straight



LACRIMAL
44301-00
curved



McIntyre
44310-00
straight



McIntyre
44311-00
curved



Air Injection
44320-00 27 gauge
44330-00 30 gauge



JENSEN
44340-00 23 gauge
44350-00 25 gauge

Spül- und Saugkanülen, Augenkanülen
Irrigation and Aspiration Cannulas, Eye Cannulas
Cánulas de irrigación y aspiración, Cánulas oculares
Cannule per irrigazione ed aspirazione, Cannule oculistiche



BISHOP-HARMON

44370-00	complete
44371-00	silicone bulb
44372-00	adaptor
44373-00	19 gauge cannula
44374-00	21 gauge cannula

Augenkanülen, Tonometer
 Eye Cannulas, Tonometer
 Cánulas oculares, Tonómetro
 Cannule oculistiche, Tonometro



SHEETS
 44380-00

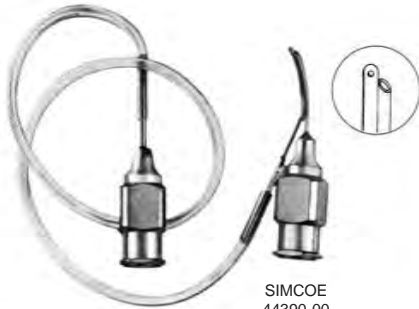

SIMCOE
 44390-00



SCHIOETZ
 44404-00 44406-00
 Skala gerade schräg
 scale straight oblique
 escala recta oblicua
 scala retta obliqua

Augenmagnet, Cilienpinzetten
 Eye Magnet, Cilia Forceps
 Imán para cuerpos extraños, Pinzas depilatorias
 Calamita per corpi estranei, Pinze depilatorie



REDA
44408-00



BEER
44420-09
9 cm, 3 1/2"



DOUGLAS
44422-09
9 cm, 3 1/2"



LITTAUER
44424-08
8,5 cm, 3.4"



BARRAQUER
44425-10
10,5 cm, 4.1"



REDA
44426-09
9 cm, 3 1/2"



GRADLE
44428-09
9,5 cm, 3 3/4"

Ohrspekula
Ear Specula
Espéculos auriculares
Specoli auriculari



POLITZER
45009-00
Set = 3

- Innen Ø
○ = 2 mm
45009-02
- = 3 mm
45009-03
- = 4 mm
45009-04



HARTMANN
45010-00
Set = 4

- Innen Ø
○ = 2 mm
45010-20
- = 3 mm
45010-30
- = 4,5 mm
45010-45
- = 5,5 mm
45010-55
- = 6,5 mm
45010-65
- = 7,5 mm
45010-75



HARTMANN
45011-00
Set 3-7 mm

- schwarz
black
negro
nero
- Innen Ø
○ = 3 mm
45011-03
- = 4 mm
45011-04
- = 5 mm
45011-05
- = 7 mm
45011-07
- = 8 mm
45011-08



TOYNBEE
45012-00
Set = 3

- Innen Ø
○ = 4 mm
45012-40
- = 5,5 mm
45012-55
- = 6,5 mm
45012-65
- = 7,5 mm
45012-75



GRUBER, rund
45014-00
Set = 4

- Innen Ø
○ = 4,5 mm
45014-45
- = 5,5 mm
45014-55
- = 6,5 mm
45014-65
- = 7,5 mm
45014-75



GRUBER, oval
45015-00
Set = 4

- Innen Ø
○ = 4,5 mm
45015-45
- = 5,5 mm
45015-55
- = 6,5 mm
45015-65
- = 7,5 mm
45015-75



BOUCHERON
45018-00
Set = 4

- Innen Ø
○ = 5 mm
45018-50
- = 6 mm
45018-60
- = 7 mm
45018-70
- = 8 mm
45018-80

Ohrspekula
Ear Specula
Espéculos auriculares
Specoli auricolari

○
45020-01
Ø 3 mm

○
45020-02
Ø 4 mm

○
45020-03
Ø 5 mm

○
45020-04
Ø 6 mm

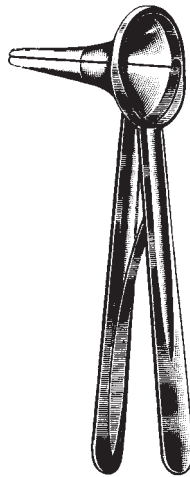

RICHNAU-HOLMGREN

Ohrspekula
Ear Specula
Espéculos auriculares
Specoli auricolari

6,5 mm



45030-06

7,5 mm



45030-07

8,2 mm



45030-08

10 mm



45030-10

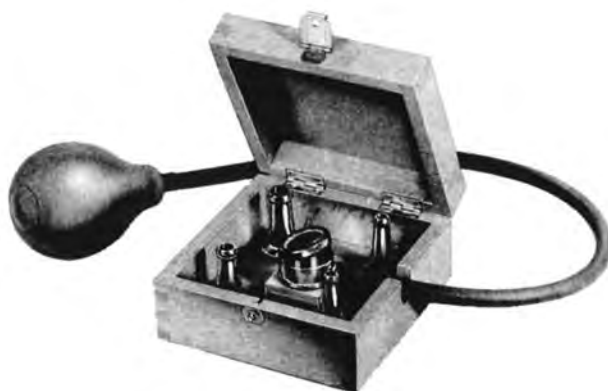

BRUENINGS
45030-04
compl.

Komplett bestehend aus:
4 Spekula, Saugkammer mit
Gebläse, Holzetui

Complete consisting of:
4 specula, suction head and rubber
tube with bulb, wooden case

Compuesto de:
4 espéculos, cámara de aspiración,
insuflador de goma, en estuche de
madera

Composta da:
4 specoli, camera aspirante con
soffiatrice, scatola di legno

Ersatzteile / spare parts /
repuestos / pezzi di ricambio

45036-09
Lupe / Magnification glass /
lupa / lente d'ingrandimento

45036-10
Saugpumpe / rubber ball /
pera de goma / soffiatrice di gomma

Ohrspekula
 Ear Specula
 Espéculos auriculares
 Specoli auricolari



6,5 mm Ø



45036-06



7 mm Ø



45036-07



8 mm Ø



45036-08

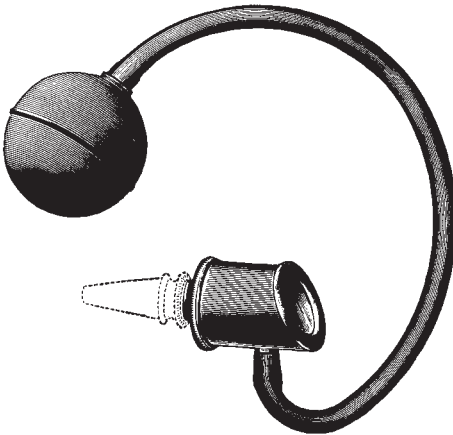

SIEGLE
 45036-03
 compl.

Komplett bestehend aus:
 Ohrspekulum, 3 Spekula, 1 Gebläse

Complete consisting of:
 Ear Specula, 1 rubber tube with bulb

Compuesto de:
 Otoscopio con 3 espéculos, insuflador y tubo

Composta da:
 Otoscopio con 3 specoli e 1 insufflatore con tubo

Stimmgabeln
Tuning Forks
Diapasones
Diapason

ALU

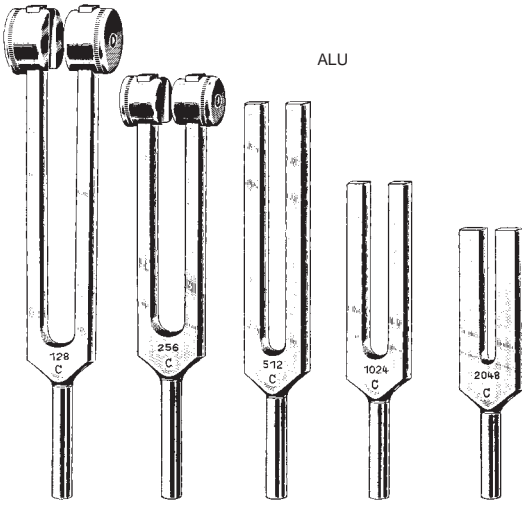

45060-01 C 128
45060-02 C' 256
45060-03 C² 512
45060-04 C³ 1024
45060-05 C⁴ 2048



45061-00 compl.

STAINLESS

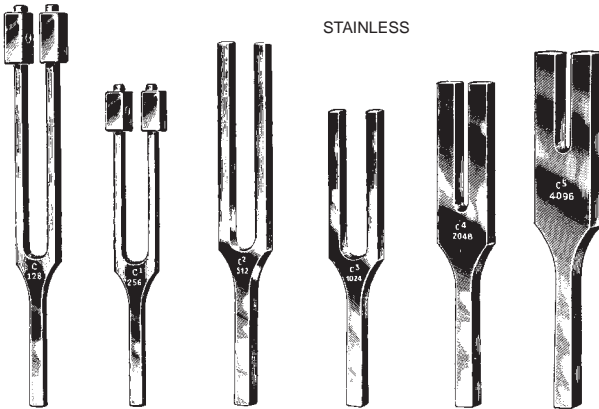

45070-01 C 128
45070-02 C' 256
45070-03 C² 512
45070-04 C³ 1024
45070-05 C⁴ 2048
45070-06 C⁵ 4096



HARTMANN
45071-00 compl.

Stimmgabeln
 Tuning Forks
 Diapasones
 Diapason



45072-01
 a¹ 440



LUCAE
 45073-01 C 128
 45073-02 C¹ 256
 45073-03 C² 512
 45073-04 C³ 1024
 45073-05 C⁴ 2048
 45073-06 C⁵ 4096



LUCAE
 45074-01
 C 128



45075-00



RYDEL-SEIFFERT
 45076-01 C 128 / C 64

Lärmtrommel, Pulverbläser
 Noise Apparatus, Powder Blowers
 Ensordecedor, Lanzapolvo
 Assorditore, Insoffiatori per polvere



BARANY
45080-00

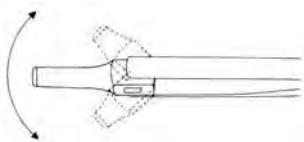
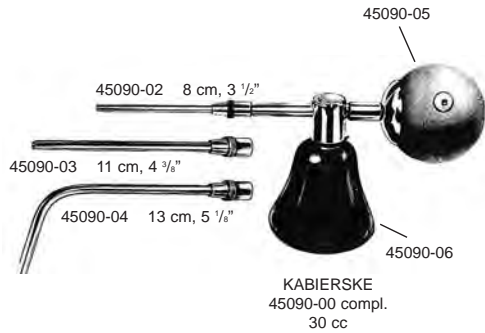

Universal
45090-08

Komplett mit beweglicher Düse,
 Schraubflasche 30 ccm und Halbgebläse
 complete with movable tube, screw bottle
 30 ccm and rubber bulb
 completo con tubo móvil botella con rosca
 30 ccm y pera de goma
 completo con tubo mobile, bottiglia con
 filettatura 30 ccm e pera di insufflazione



Luftdusche, Ohrspritze
 Air Bag, Ear Syringe
 Insuflador de aire, Jeringa
 Insoffiatore d'aria, Siringa Auricolare



45091-02
 Gummibirne alleine
 Rubber bulb only
 Pera de goma, sola
 Pera di gomma, sola



45091-03



45091-04
 4 mm Ø



45091-15
 15 mm Ø



45091-17
 17 mm Ø



45091-22
 22 mm Ø

POLITZER
 45091-00 Set
 incl.
 45091-03
 45091-15
 45091-17
 45091-22

POLITZER
 45091-01 Set
 incl.
 45091-03
 45091-04
 45091-15
 45091-17
 45091-22



ml REINER
 compl.
 50 45096-50
 75 45096-75
 100 45097-10
 150 45097-15



45097-01



45097-02



45097-03

Spritze, Küretten
 Syringe, Curettes
 Jeringa, Curetas
 Siringa, Curette



45098-01 1 ml
 45098-02 2 ml
 45098-05 5 ml
 45098-10 10 ml
 45098-20 20 ml
 45098-50 50 ml

45099-01 1 ml
 45099-02 2 ml
 45099-05 5 ml
 45099-10 10 ml
 45099-20 20 ml
 45099-50 50 ml



Küretten
 Curettes
 Curetas
 Curette

stumpf
 blunt
 romas
 smusse



Fig. 00

0

1

2

3

4

5

45109-00

45110-00

45110-01

45110-02

45110-03

45110-04

45110-05

scharf
 sharp
 cortantes
 taglienti



45111-00

45112-00

45112-01

45112-02

45112-03

45112-04

45112-05

stumpf
 blunt
 romas
 smusse



45114-00

45115-00

45115-01

45115-02

45115-03

45115-04

45115-05

scharf
 sharp
 cortantes
 taglienti



45116-00

45117-00

45117-01

45117-02

45117-03

45117-04

45117-05

BUCK
 14,5 cm, 5 3/4"

Ohrkatheter, Parazentese Nadeln, Ohrmesser
 Catheters, Paracentesis Needles, Ear Knives
 Cateteres, agujas para paracentesis, Cuchillos auriculares
 Cateteri, Aghi per paracentesi, Coltelli auricolari

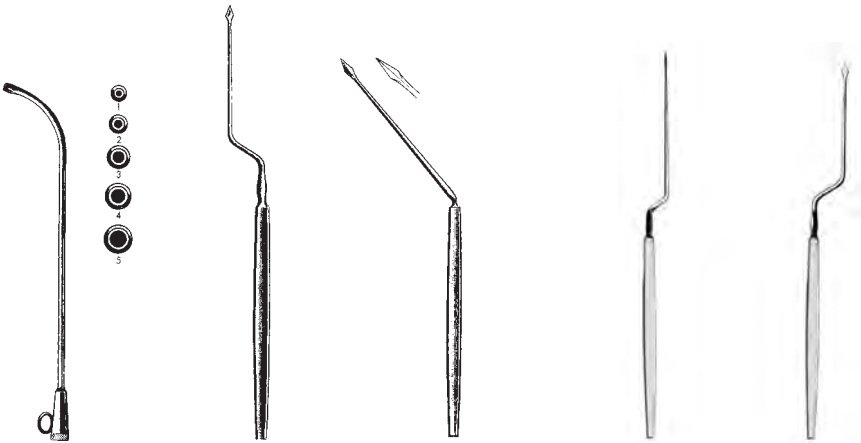

Fig. HARTMANN

- 1 45133-01 3,5 mm
- 2 45133-02 4,0 mm
- 3 45133-03 4,5 mm
- 4 45133-04 5,0 mm
- 5 45133-05 6,0 mm

POLITZER
 45150-18
 18 cm, 7"

POLITZER
 45151-16
 16,5 cm, 6 1/2"

LUCAE
 45152-01
 18 cm, 7"

LUCAE
 45152-02
 18 cm, 7"

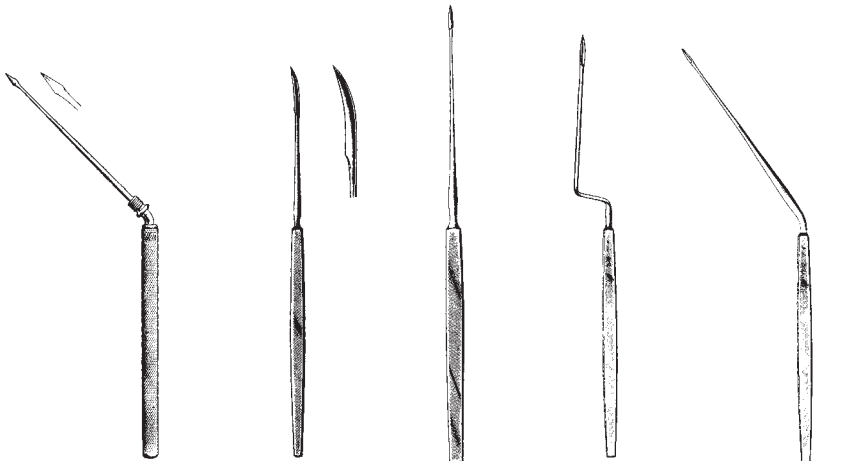

POLITZER
 45153-16
 16 cm, 6 1/4"

POLITZER
 45160-15
 15 cm, 6"

SEXTON
 45162-18
 18 cm, 7"

SEXTON
 45164-17
 17 cm, 6 3/4"

SEXTON
 45165-17
 17 cm, 6 3/4"

Löffel, Schlingen, Häkchen
 Ear spoons, Loops, Hooklets
 Cucharas, Asas, Ganchitos
 Cucchiain, Anse, Uncinetti



GROSS
 45171-12
 12 cm, 4 3/4"



BILLEAU
 45180-01 - 45180-03
 16 cm, 6 1/2"

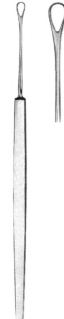
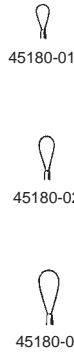

LANGENBECK
 45181-13
 13 cm, 5 1/8"



ZAUFAL
 45184-16
 16 cm, 6 1/4"



ZAUFAL-JANSEN
 45185-15
 15 cm, 6"



DAY
 45190-01 - 45190-02
 16 cm, 6 1/2"

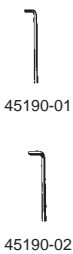

WAGENER
 45192-01 - 45192-04
 14 cm, 5 1/2"



LUCAE
 45193-01 - 45193-03
 14 cm, 5 1/2"

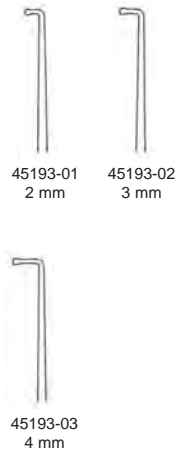

Schlingen, Pinzetten
 Loops, Dressing Forceps
 Asas, Pinzas
 Anse, Pinze

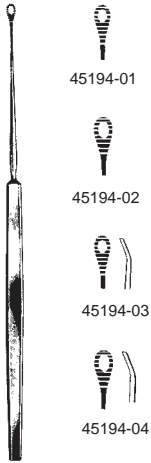

SHAPLEIGH
 45194-01 - 45194-04
 13 cm, 5 1/8"

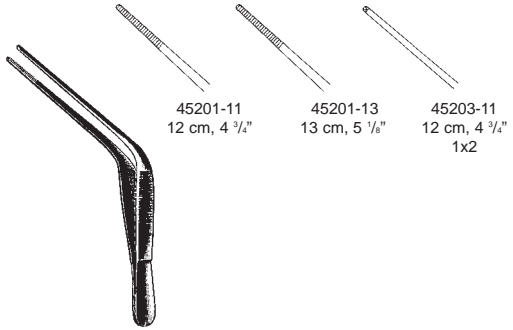

WILDE (TROELTSCH)



LUCAS
 45206-14
 14 cm, 5 1/2"



LUCAS
 45206-16
 16 cm, 6 1/4"



COTTLE
 45208-14
 14 cm, 5 1/2"

Polypenschnürer, Ohrzängchen
 Snares, Ear Forceps
 Cierra-nudos, Pinzas auriculares
 Serranodi, Pinze auricolari



KRAUSE
 45220-16
 16 cm, 6 1/4"



WILDE
 45222-17
 17 cm, 6 3/4"



45225-02
 doz./doc./dozz.
 0,2 mm

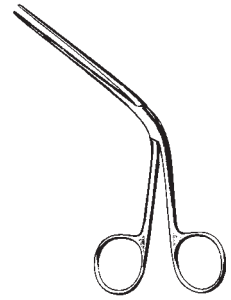

TILLEY
 45243-14
 14 cm, 5 1/2"



LITTAUER
 45245-12
 12 cm, 4 3/4"

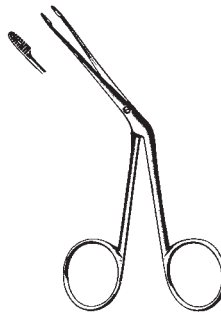

HARTMANN
 45246-12
 12 cm, 4 3/4"

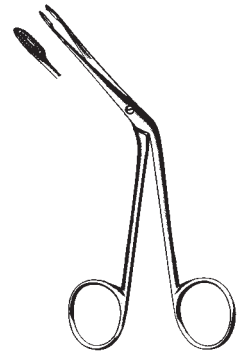

HARTMANN
 45246-14
 14 cm, 5 1/2"

Fremdkörperheber, Fremdkörperzängchen
 Foreign Body Levers, Ear Polypus Forceps
 Elevadores para cuerpos extraños, Pinzas para pólipos
 Leve per corpi estranei, Pinze per polipi



QUIRE
 45251-10
 10 cm, 4"

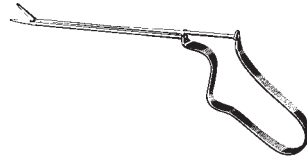

BUCK
 45253-11
 11 cm, 4 3/8"

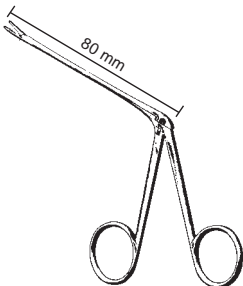

45255-08 - 45275-08



HARTMANN-WULLSTEIN
 45255-08
 8,5 cm, 3,4"



HARTMANN-WULLSTEIN
 1 mm 45257-08
 8,5 cm, 3,4"



HARTMANN
 45261-08 8,5 cm, 3,4"
 45261-14 14,0 cm, 5 1/2"
 45261-16 16,0 cm, 6 1/4"



HARTMANN
 45263-08 8,5 cm, 3,4"
 45263-14 14,0 cm, 5 1/2"



HARTMANN
 45265-08
 8,5 cm, 3,4"



Ø mm HARTMANN
 2,0 45267-20 8,5 cm, 3,4"
 2,5 45267-25 8,5 cm, 3,4"
 3,0 45267-30 8,5 cm, 3,4"



○ 3 mm Ø
 HARTMANN
 45269-30
 8,5 cm, 3,4"



STRUEMPEL
 45271-08 8,5 cm, 3,4"
 2,5x5 mm



HARTMANN
 45273-08
 8,5 cm, 3,4"

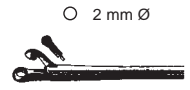

○ 2 mm Ø
 HARTMANN-HOFFMANN
 45275-08
 8,5 cm, 3,4"

Micro-Ohrscheren, Micro-Ohrzangchen
 Micro Ear Scissors, Micro Ear Forceps
 Tijeras auriculares micro, Pinzas auriculares micro
 Forbici auricolari micro, Pinze auricolari micro

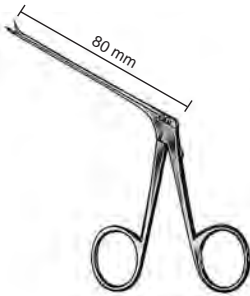

45310-40 - 45322-70

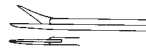

A
 BELLUCCI
 45310-40
 micro mini
 4 mm

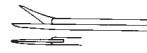

A
 BELLUCCI
 45312-55
 micro standard
 5,5 mm

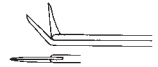

D
 BELLUCCI
 45313-55
 micro standard
 5,5 mm



B
 BELLUCCI
 45315-55
 micro standard
 5,5 mm

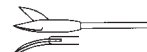

C
 BELLUCCI
 45317-55
 micro standard
 5,5 mm



A
 SHEA
 45320-70
 7,0 mm

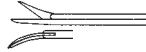

C
 SHEA
 45321-70
 7,0 mm

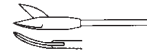

B
 SHEA
 45322-70
 7,0 mm

- A: gerade / straight / recta / retta
- B: rechts / right / derecha / destra
- C: links / left / izquierda / sinistra
- D: aufgebogen / curved up / curva in alto / curva hacia arriba
- E: nach unten gebogen / curved down / curva in basso / curva hacia abajo

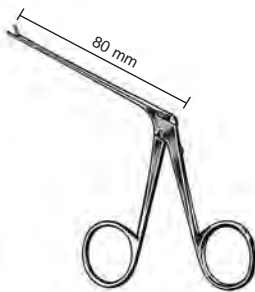

45350-40 - 45360-35

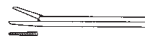

A
 45350-40
 4 mm

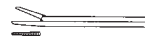

A
 45350-70
 7 mm



A
 45352-40
 4 mm



C
 45353-60
 6 mm



B
 45355-60
 6 mm



D
 45357-40
 4 mm



E
 45359-40
 4 mm



A
 45360-35
 3,5 mm

Micro-Ohrzängchen
 Micro Ear Forceps
 Pinzas auriculares micro
 Pinze auricolari micro

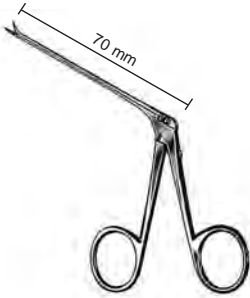

45362-45 - 45383-30



A
 45362-45
 4,5 mm



C
 45363-45
 4,5 mm

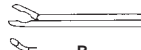

B
 45365-45
 4,5 mm

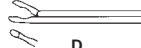

D
 45367-50
 5,0 mm

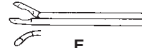

E
 45369-50
 5,0 mm

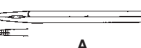

A
 GREVEN
 45370-50
 5,0 mm



McGEE
 45371-40
 0,8x4,0 mm



COS
 45373-30
 1,8x0,8x3,0 mm



JUERS
 45375-60
 6,0 mm



JUERS
 45377-60
 6,0 mm



C
 HAUGH
 45381-30
 45° 3 mm



B
 HAUGH
 45383-30
 45° 3 mm

- A:** gerade / straight / recta / retta
B: rechts / right / derecha / destra
C: links / left / izquierda / sinistra
D: aufgebogen / curved up / curva in alto / curva hacia arriba
E: nach unten gebogen / curved down / curva in basso / curva hacia abajo

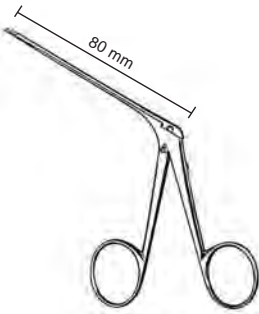

DIETER
 45385-01 - 45387-02

micro ø 1,3 mm



45385-01

aufwärts
 upward
 arriba
 in alto

mini ø 1,8 mm



45387-01



45385-02

abwärts
 downward
 abajo
 in basso



45387-02

Micro-Ohrzängchen
 Micro Ear Forceps
 Pinzas auriculares micro
 Pinze auricolari micro



45390-35
 0,8 x 3,5 mm



45390-50
 1 x 5 mm



45391-35
 0,8 x 3,5 mm



45392-35
 0,8 x 3,5 mm



45393-50
 1 x 5 mm



45394-50
 1 x 5 mm

Micro-Ohrzängchen
 Micro Ear Forceps
 Pinzas auriculares micro
 Pinze auricolari micro



WULLSTEIN



45400-01
 0,9 x 1 mm



45400-02
 0,8 x 1,3 mm



45400-03
 1 mm



45401-25
 1,7 x 2,5 mm



45402-10
 0,9 x 1 mm



45403-13
 0,8 x 1,3 mm



45404-13
 0,8 x 1,3 mm

Micro-Ohrscheren
Micro Ear Scissors
Tijeras auriculares micro
Forbici auricolari micro



BELLUCCI



45410-01



45411-01



45412-01



45413-01



45414-01

Messer
Knives
Cuchillos
Cotelli



SCHUKNECHT
45701-01
16 cm, 6 1/4"



SCHUKNECHT
45701-02
16 cm, 6 1/4"



SCHUKNECHT
45703-15
15,5 cm, 6"



WULLSTEIN
45704-15
15,5 cm, 6"



TABB
45705-15
15,5 cm, 6"



PLESTER
45706-35
15,5 cm, 6"

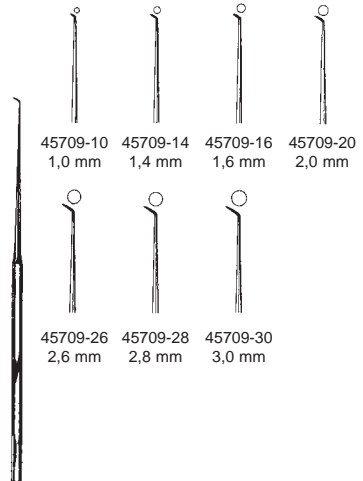

45709-10 1,0 mm 45709-14 1,4 mm 45709-16 1,6 mm 45709-20 2,0 mm

45709-26 2,6 mm 45709-28 2,8 mm 45709-30 3,0 mm

ROSEN
45709-10 - 45709-30
16 cm, 6 1/4"

Nadeln und Hakchen
 Needles and Hooks
 Agujas y Ganchos
 Aghi e uncini



16 cm
 6 1/4"



BARBARA
 45710-15



BARBARA
 45711-15



BARBARA
 45713-15



BARBARA
 45715-17



25°
 SHAMBAUGH



45°
 SHAMBAUGH



90°
 SHAMBAUGH



BARBARA
 45725-05=0,5 mm
 45725-10=1,0 mm

mm
 0,3
 0,6
 1,0
 1,2
 1,5
 2,0
 2,5

45720-03
 45720-06
 45720-10

45722-03
 45722-06
 45722-10
 45722-12
 45722-15
 45722-20
 45722-25

45724-03
 45724-06
 45724-10
 45724-12
 45724-15
 45724-20
 45724-25



45730-03 - 45747-10
 15,5 cm, 6"



90°



90°

mm
 0,3
 0,6
 1,0

45730-03
 45730-06
 45730-10

45732-03
 45732-06
 45732-10



McGEE



McGEE

mm
 0,5
 1,0

45733-05
 45733-10

45735-05
 45735-10



BARBARA
 45736-15
 15,5 cm, 6"



ROSEN
 45737-15
 15,5 cm, 6"



mm

25°



25°



45°



45°

0,3 45741-03 45743-03 45745-03 45747-03
 0,6 45741-06 45743-06 45745-06 45747-06
 1,0 45741-10 45743-10 45745-10 45747-10

Dissektoren, Küretten, Elevatoren, Mikro-Meßsonde
 Dissectors, Curettes, Elevators, Micro measuring rod
 Disectores, Curetas, Elevadores, Sonda para medir
 Dissettori, Curette, Elevatori, Sonda auricolare per misurare

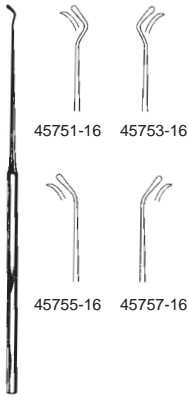

45751-16 45753-16

45755-16 45757-16

FISCH
 45751-16 - 45757-16
 16 cm, 6 1/4"

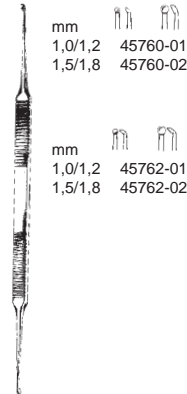

mm
 1,0/1,2 45760-01
 1,5/1,8 45760-02

mm
 1,0/1,2 45762-01
 1,5/1,8 45762-02

HOUSE
 45760-01 - 45762-02
 15 cm, 6"



45802-16
 2 mm

45803-16
 2 mm

45805-16
 3 mm

LEMPERT
 45802-16 - 45805-16
 16 cm, 6 1/4"

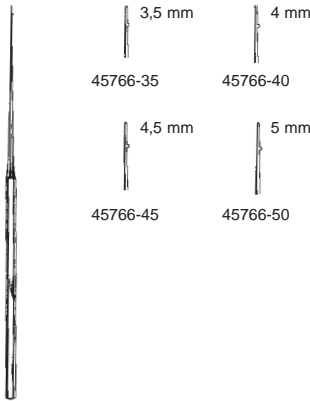

3,5 mm
 45766-35

4 mm
 45766-40

4,5 mm
 45766-45

5 mm
 45766-50

HOUSE
 45766-35 - 45766-50
 16 cm, 6 1/4"



LEMPERT
 45807-20
 20,5 cm, 8"

Nasenspekula
 Nasal Specula
 Espéculos nasales
 Specoli nasali



THUDICHUM
 47050-01 - 47050-07

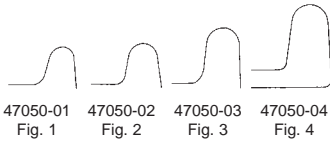

47050-01 Fig. 1 47050-02 Fig. 2 47050-03 Fig. 3 47050-04 Fig. 4



47050-05 Fig. 5 47050-06 Fig. 6 47050-07 Fig. 7



VOLTOLINI
 47060-01 - 47060-03

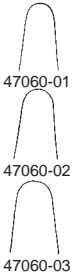

leichtes Modell
 lightweight
 mod. ligero
 mod. leggero

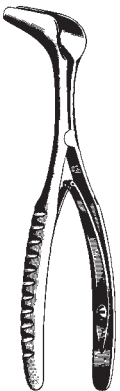

HARTMANN-HALLE
 47102-01 - 47102-03
 15 cm, 6"

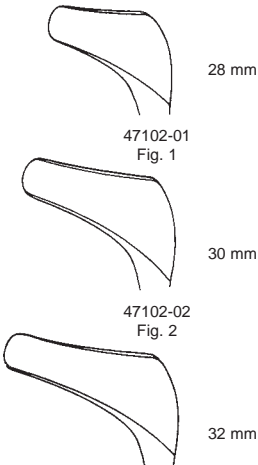

47102-01
 Fig. 1

47102-02
 Fig. 2

47102-03
 Fig. 3

Baby, bebé
 Kind, child, niño, bamb.
 Erwachs., Adult, adulto

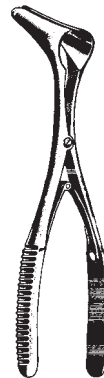

Mod. VIENNA
 47112-01 25 mm
 47112-02 30 mm
 47112-03 35 mm

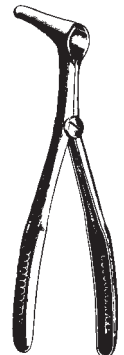

Mod. VIENNA
 47113-03

Nasenspekula
Nasal Specula
Espéculos nasales
Specoli nasali



1/1



Nasenspekula, Kehlkopfspiegel
 Nasal Specula, Laryngeal Mirrors
 Espéculos nasales, espejos laringeos
 Specoli nasali, Specchi laringei

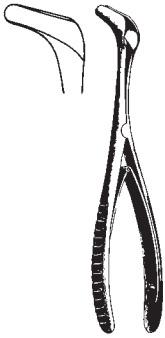

TIECK-HALLE
 47116-13
 13,5 cm, 5 1/4"



REDA
 47118-13
 12,5 cm, 5"



KILLIAN
 47120-35 - 47120-90
 13 cm, 5 1/8"



47120-35
 35 mm

47120-50
 50 mm

47120-75
 75 mm

47120-90
 90 mm



COTTLE
 47124-35 - 47124-90
 14 cm, 5 1/2"

47124-35 35 mm
 47124-50 50 mm
 47124-75 75 mm
 47124-90 90 mm



MICHEL
 47139-12 - 47139-18
 25 cm, 10"



47139-12
 12 mm



47139-14
 14 mm



47139-16
 16 mm



47139-18
 18 mm

Nasenpinzetten, Polypenzange
 Ear Dressing Forceps, Ear Polypus Forceps
 Pinzas auriculares, Pinzas para pólipos
 Pinze auricolari, Pinze per polipi

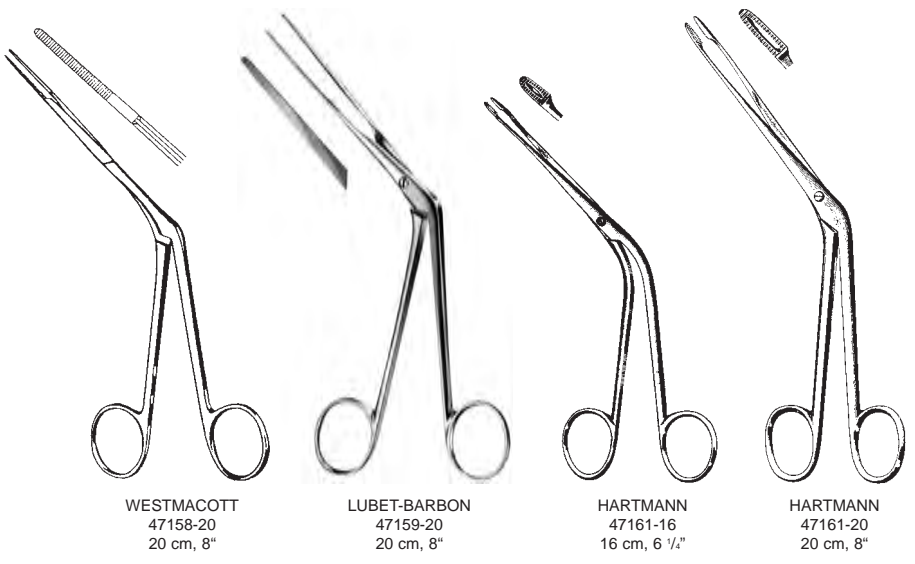
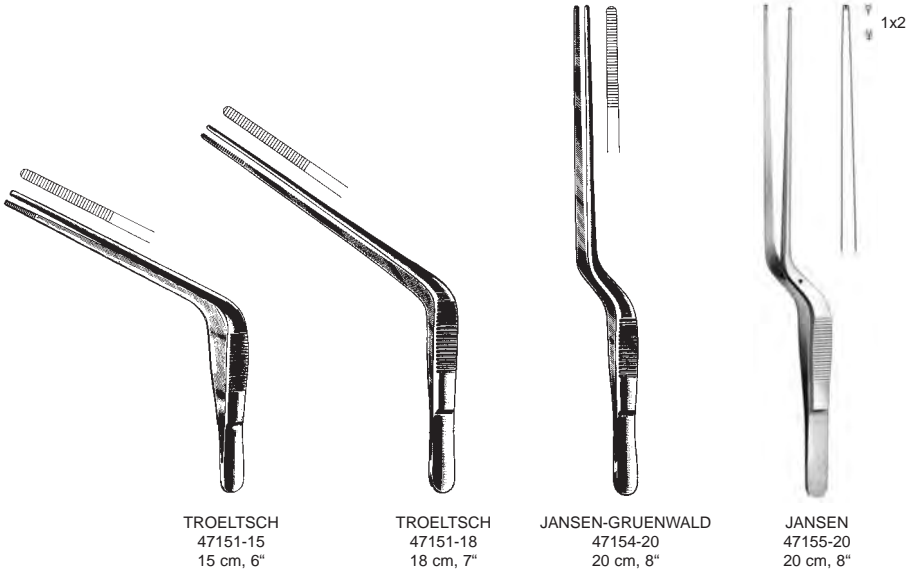

Polypenzangen, Septumzangen
 Nasal Polypus and Septum Forceps
 Pinzas para pólipos y para el tabique nasal
 Pinze per polipi, Pinze per il setto nasale

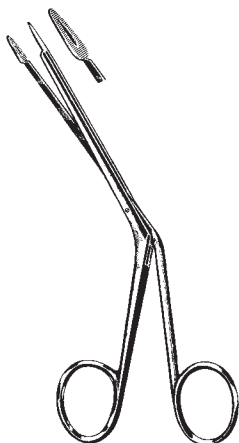

LITTAUER
 47167-18
 18 cm, 7"

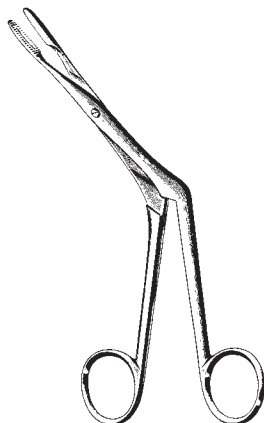

HEYMANN-KNIGHT
 47169-18
 18 cm, 7"

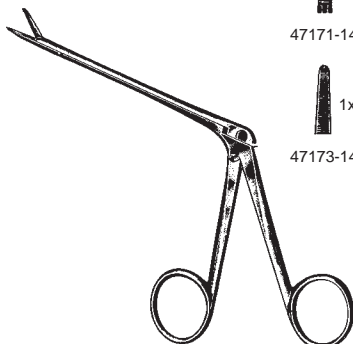

NOYES
 47171-14 - 47173-14
 14,5 cm, 5 3/4"

47171-14

1x2

47173-14

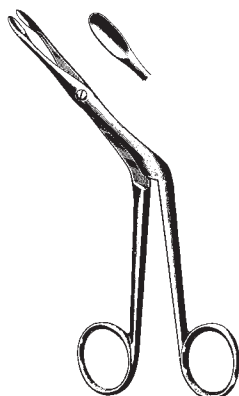

HEYMANN
 47181-18
 18 cm, 7"

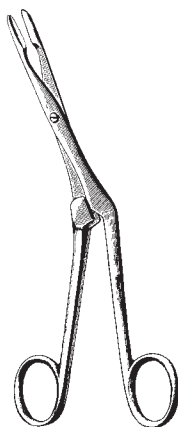

KNIGHT
 47185-18
 18 cm, 7"

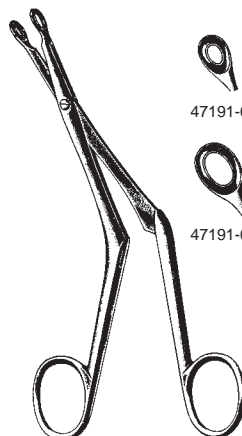

BRUENINGS
 47191-01 - 47191-04
 19 cm, 7 1/2"

47191-01

47191-02

47191-03

47191-04

Scharfe Nasenzangen, Septumzangen
 Nasal Cutting Forceps, Septum Forceps
 Pinzas cortantes nasales y para el tabique nasal
 Pinze taglianti nasali, Pinze per il setto nasale



GRAIG
 47192-16
 16 cm, 6 1/2"

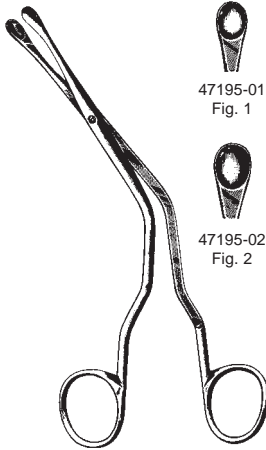

LUC
 47195-01 - 47195-05
 19 cm, 7 1/2"

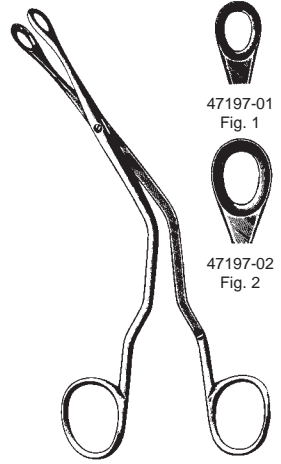

LUC
 47197-01 - 47197-02
 19 cm, 7 1/2"

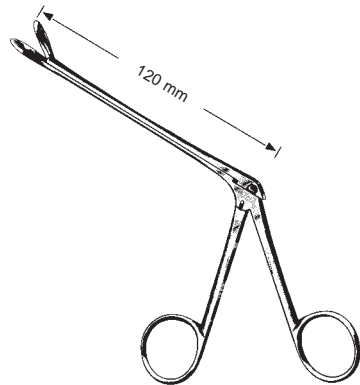
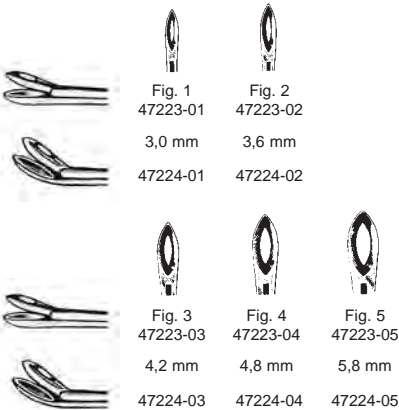

WEIL-BLAKESLEY
 47223-01 - 47224-05

Scharfe Nasenzangen
Nasal Cutting Forceps
Pinzas cortantes nasales
Pinze taglianti nasali

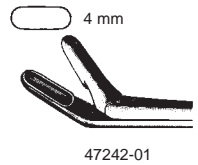
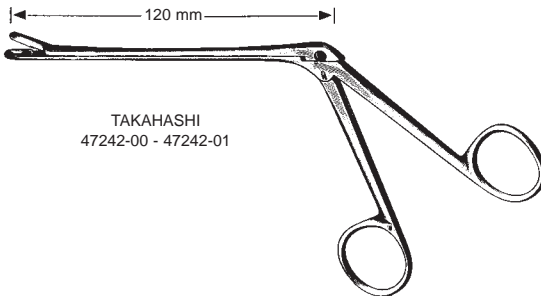
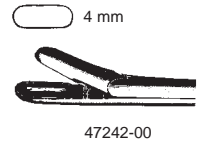
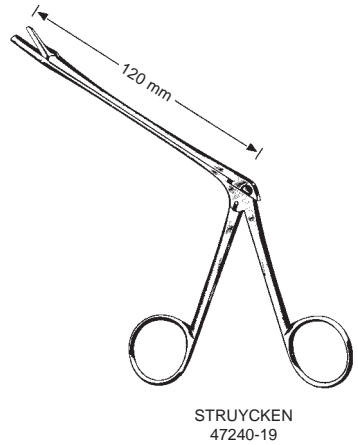
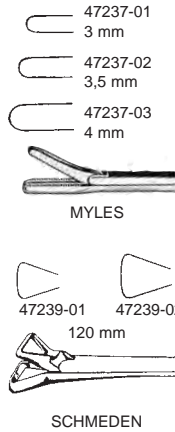
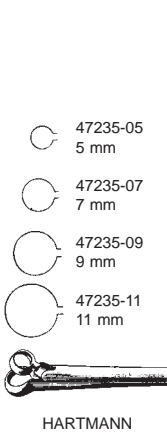

Scharfe Nasenzangen, Septumzange, Kieferhöhlenstanze
 Nasal Cutting Forceps, Septum Forceps, Antrum Punch Forceps
 Pinzas cortantes nasales, Pinza para magullar tabique, Pinzas cortantes para maxilares
 Pinze taglianti nasali, Pinza per ammaccare il setto, Pinze taglianti per seno mascellare



RUBIN
 47251-21
 21 cm, 8 1/4"

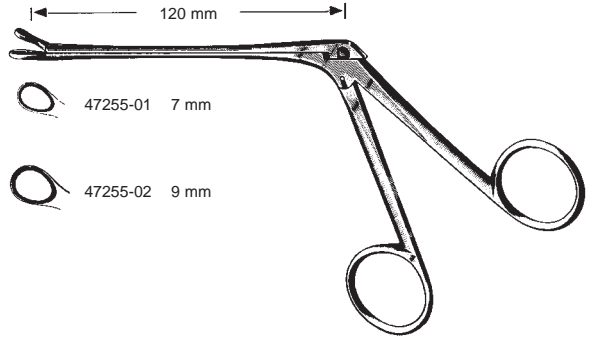

WATSON-WILLIAMS
 47255-01

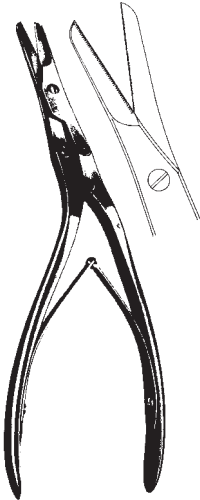

CAPLAN
 47256-20
 20 cm, 8"



KERRISON
 3x3 mm 47303-03
 4x4 mm 47303-04
 5x5 mm 47303-05
 6x6 mm 47303-06
 17 cm, 6 1/2"

Kieferhöhlenstanze, Nasenschere
 Antrum Punch Forceps, nasal scissors
 Pinzas cortantes para maxilares, tijera nasal
 Pinze sfenoidali, forbici nasali



47304-01 5x3,5 mm



47304-03 5x4 mm



47304-02 5x3,5 mm



47304-04 5x4 mm



HAJEK-KOFLER
 47304-01 - 47304-04



47305-02
 rechts gebogen
 right curved
 curva a la derecha
 curva a destra



47305-03
 links gebogen
 left curved
 curva a la izquierda
 curva a sinistra



47305-01
 gerade
 straight
 recta
 retta



Knochenstanze, Septumzangen
 Punches, Septum Forceps
 Pinzas osteótomas, Pinzas para el tabique nasal
 Pinze osteotomi, Pinze per il setto nasale

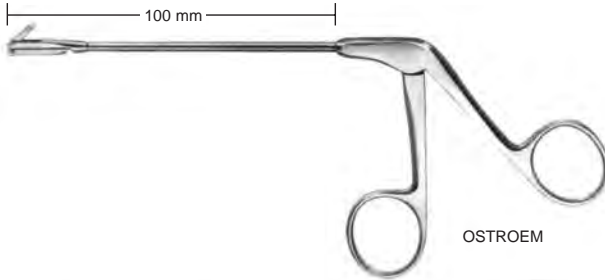

OSTROEM



47315-00
 2 mm
 oben schneidend
 up cutting
 cortante por arriba
 tagliente in alto



47316-00
 2 mm
 rechts schneidend
 right cutting
 cortante a la derecha
 tagliente a destra



47317-00
 2 mm
 links schneidend
 left cutting
 cortante a la izquierda
 tagliente a sinistra



CITELLI
 47311-10 1,0 mm
 47311-25 2,5 mm
 47311-30 3,0 mm

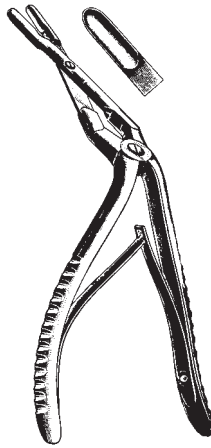

MIDDLETON-JANSEN
 47323-19
 19 cm, 7 1/2"

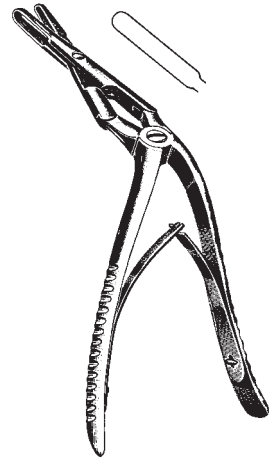

MIDDLETON-JANSEN
 47325-19
 19 cm, 7 1/2"

Kieferhöhlenstanze, Sinuskopie-Zangen
 Antrum Punch Forceps, Sinuscopy forceps
 Pinzas cortantes para maxilares, Pinzas para senoscopia
 Pinze sfenoidali per seno mascellare, Pinze per sinuscopia



HAJEK-KOFLER
 47316-16
 3,5 mm

○
 1/1

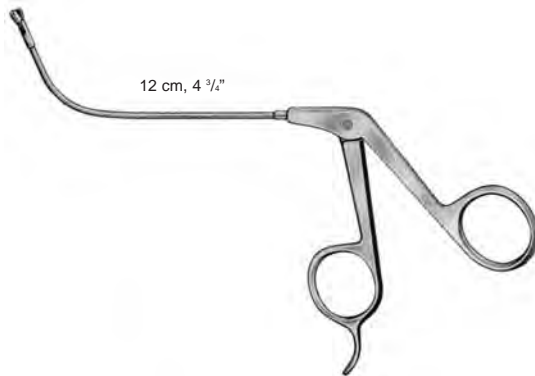

	Maul jaw boca morso	horizontal öffnend horizontal cutting abierta horizontal apertura orizzontale	vertikal öffnend vertical cutting abierta vertical apertura verticale
65°	○ 3 mm rund	47317-65	47318-65
70°	○	47317-70	47318-70
90°	○ } oval	47317-90	47318-90
110°	○ }	47317-11	47318-11

Zirkular Stanze
Circular Forceps
Pinza circular
Pinza circolare



47319-35 3,5 mm
47319-45 4,5 mm

Spülkanülen, Punktionskanüle, Stirnhöhledilatator
 cannulas, Antrum trocar needle, Frontal sinus bougies
 cánulas, cánula de punción, Dilatador para el seno
 cannulas, cannula per punzione, Dilatatore per seno frontale

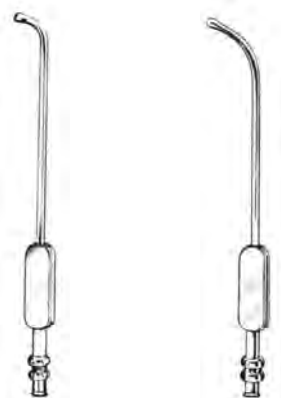

EICKEN (KILLIAN)
 14,5 cm, 5 3/4"

	Ø	
47331-20	2,0 mm	47332-20
47331-25	2,5 mm	47332-25
47331-30	3,0 mm	47332-30
47331-40	4,0 mm	47332-40



HARTMANN

Fig. 1	Ø	Fig. 2
47338-20	2,0 mm	47339-20
47338-25	2,5 mm	47339-25
47338-30	3,0 mm	47339-30



Ø mm	LICHTWITZ
1,5	47340-15
1,8	47340-18
2,0	47340-20

Luer-Lock
 10 cm, 4"



Ø mm	RITTER-HALLE
2,5	47342-25
3,0	47342-30
4,0	47342-40

Kiefer- und Stirnhöhlen-Spülkanülen, Saugraspatorium
 Antrum and Frontal Sinus Wash Cannulas, Suction Raspatory
 Cànulas lavadoras para seno maxilar y seno frontal, Legra de succión
 Cannule per seno mascellare e seno frontale, Raspatorio con aspiratore



Ø mm	
1,5	47343-15
1,7	47343-17
2,0	47343-20
2,5	47343-25
3,0	47343-30



Ø mm	
1,5	47344-15
1,7	47344-17
2,0	47344-20
2,5	47344-25
3,0	47344-30



SIEBENMANN
47343-15 - 47344-30



KILLIAN
Ø 1,5 mm
47345-15



GUILLEN
19 cm, 7 1/2"
47347-20

Polypenschnürer
 Ear Polypus Snares
 Polipótomos
 Serranodi



KRAUSE-VOSS
 47350-26
 26 cm, 10 1/4"



KRAUSE
 47351-26
 26 cm, 10 1/4"



WILDE
 47352-24
 24 cm, 9 1/2"



12x

47355-03 0,3 mm

Nasennesser
 Nasal Knives
 Bisturien nasales
 Coltelli nasali



JOSEPH
 47370-16 - 47373-16
 16 cm, 6 1/4"



47370-16
 stumpf, blunt,
 romos, smussi



47371-16



47372-16



47373-16

spitz, pointed,
 agudos, acuti



FREER
 47374-16
 16,5 cm, 8 1/2"



FREER
 47375-19
 19 cm, 7 1/2"



JOSEPH
 47375-16
 16,5 cm, 6 1/2"

Nasenplastik- und Operationsmesser, Sichelmesser, Küretten
 Rhinoplastic and Nasal Knives, Septum Sickle Knives, Curettes
 Bisturías para plástica y operaciones de la nariz, Bisturías para el tabique nasal, Curetas
 Bisturi per la plastica ed operazioni nasali, coltelli per setto, Curette



JOSEPH
47376-16
16 cm, 6 1/4"



CONVERSE
47379-16
16 cm, 6 1/2"



COTTLE
47380-15
15 cm, 6"



COTTLE
47382-15
15 cm, 6"



JOSEPH
47384-15
15 cm, 6"



JOSEPH
47385-15
15 cm, 6"



REDA
19 cm, 7 1/2"



47386-01
spitz
pointed
agudo
acuto



47386-02
stumpf
blunt
romo
smusso



ANTRUM
19 cm, 7 1/2"



47387-01
vorwärts schneidend
forward cutting
corte hacia adelante
taglio in avanti



47387-02
rückwärts schneidend
backward cutting
corte hacia atras
taglio retrograde

Schwingmesser
 Septum Swivel Knives
 Bisturies para el tabique nasal
 Coltelli per setto

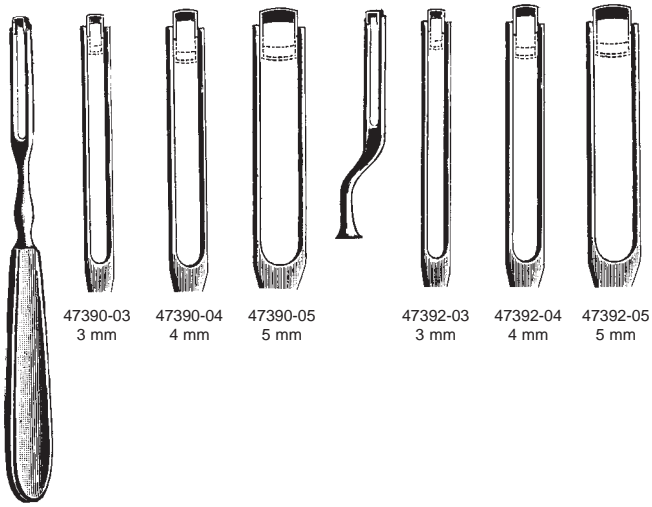

BALENGER
 47390-03 - 47392-05
 20 cm, 8"

Septum Elevatoren
 Septum Elevators
 Elevadores para el tabique
 Elevatori per setto



McKENTY
 47410-04 - 47410-05
 15 cm, 6"



47410-04
 4 mm



47410-05
 5 mm



HALLE
 47410-16
 16.5 cm, 6 1/2"



JOSEPH
 47411-16
 16 cm, 6 1/4"

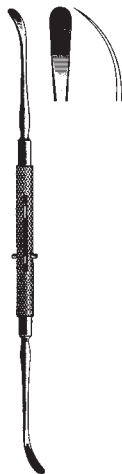

ROGER
 47413-19
 19 cm, 7 1/2"



FREER
 47415-18
 18 cm, 7"

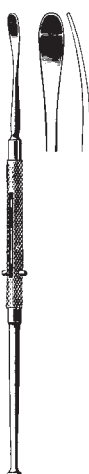

FREER
 47417-19
 19 cm, 7 1/2"

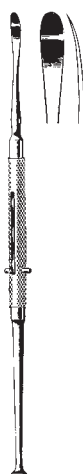

FREER
 47419-19
 19 cm, 7 1/2"

Septum Elevatoren
 Septum Elevators
 Elevadores para el tabique
 Elevatori per setto



KILLIAN
 47420-01
 18,5 cm, 7 1/4"



PIERCE
 47420-02
 21 cm, 8 1/4"



SINUS
 47420-03
 18 cm, 7"



PENNINGTON
 47420-04
 21 cm, 8 1/4"



McKENTY
 47420-20
 22 cm, 8 3/4"



HOWARTH
 47421-21
 21,5 cm, 8 1/2"

Septum Elevatoren
Septum Elevators
Elevadores para el tabique
Elevatori per setto



COTTLE
47421-23
23 cm, 9"



COTTLE JOSEPH
47422-22
22 cm, 8 3/4"



COTTLE
47423-22
22 cm, 8 3/4"

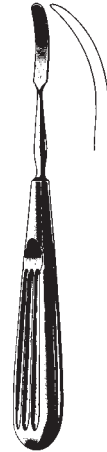

COTTLE
47424-16
16 cm, 6 1/2"



COTTLE
47425-19
19 cm, 7 1/2"



KILLIAN
47426-22
22 cm, 8 3/4"



HAJEK-BALLENGER
47428-21
22 cm, 8 3/4"



BALLENGER
47430-22
22 cm, 8 3/4"



FREER
47450-04
15 cm, 6"



FREER
47451-04
15 cm, 6"

Septum Meißel, Knorpelquetscher
 Rhinoplastic Chisels, Cartilage crusher
 Cinceles para la plástica nasal, Macha cadera
 Scalpelli per plastica nasale, Tritacartilagine

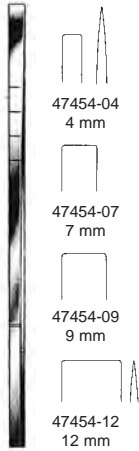

COTTLE
 47454-04 - 47454-12
 18 cm, 7"



COTTLE
 47455-06
 18 cm, 7"

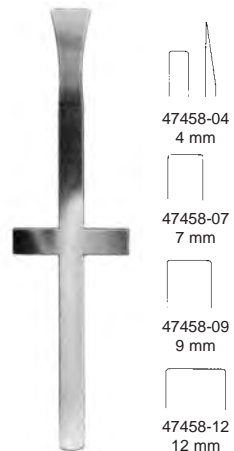

COTTLE
 47458-04 - 47458-12
 18 cm, 7"

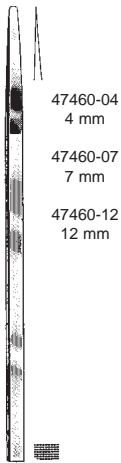

COTTLE
 47460-04 - 47460-12
 18 cm, 7"



COTTLE
 Knorpelquetscher
 47461-00

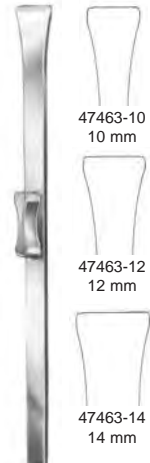

RUBIN
 18,5 cm, 7 1/4"

Septum Meißel
 Rhinoplastic Chisels
 Cinceles para la plástica nasal
 Scalpelli per plastica nasale

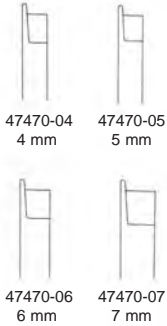

47470-04
4 mm

47470-05
5 mm

47470-06
6 mm

47470-07
7 mm

FOMON
 47470-04 - 47470-07
 17 cm, 6 3/4"

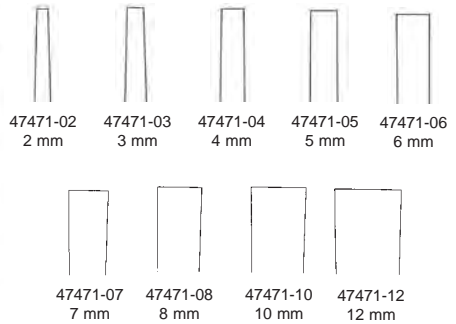

47471-02
2 mm

47471-03
3 mm

47471-04
4 mm

47471-05
5 mm

47471-06
6 mm

47471-07
7 mm

47471-08
8 mm

47471-10
10 mm

47471-12
12 mm

SHEEHAN
 47471-07 - 47471-12
 16 cm, 6 3/4"

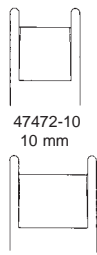

47472-10
10 mm

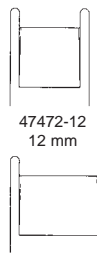

47472-12
12 mm

47472-14
14 mm

47472-16
16 mm

CINELLI
 47472-10 - 47472-16
 16 cm, 6 1/2"

Osteotom, Septum Meißel
 Osteotomes, Rhinoplastic Chisels
 Osteotomi, Cinceles para la plástica nasal
 Osteotomi, Scalpelli per plastica nasale

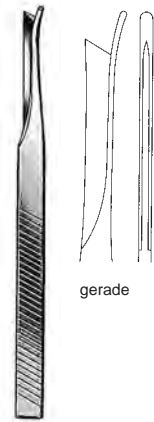

gerade

SILVER
 47473-01
 18 cm, 7"

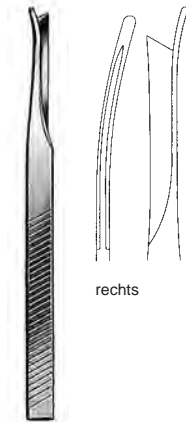

rechts

SILVER
 47473-02
 18 cm, 7"

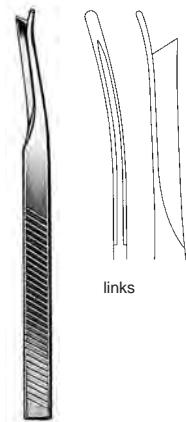

links

SILVER
 47473-03
 18 cm, 7"



47474-01
 7 mm

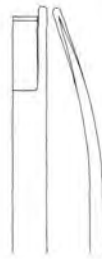

47474-02
 7 mm



47474-03
 7 mm

NEIVERT-ANDERSON
 47474-01 - 47474-03
 20,5 cm, 8"

Septum Meißel
 Rhinoplastic Chisels
 Cinceles para la plástica nasal
 Scalpelli per plastica nasale



KILLIAN
 47481-05
 16 cm, 6 1/4"



KILLIAN-CLAUS
 47482-05
 17 cm, 6 3/4"



mm	HAEJK
4	47484-04
6	47484-06
8	47484-08
	16 cm, 6 1/4"



WEST
 47486-16
 16 cm, 6 1/4"



WEST
 47487-16
 16 cm, 6 1/4"



FREER
 47489-16
 16 cm, 6 1/4"

Nasenraspeln
 Nasal Rasps
 Escofinas nasales
 Raspa nasale

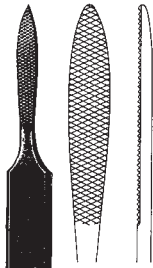

JOSEPH
 47502-16
 16 cm, 6 1/4"

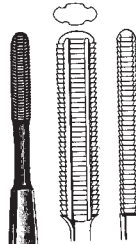

MALTZ
 47504-18
 18 cm, 7"



WIENER
 47507-17 - 47507-19
 18 cm, 7"



47507-17



47507-19

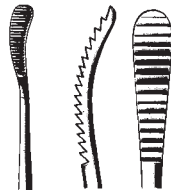

47511-21

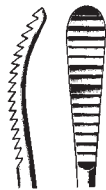

47513-21

AUFRICHT
 47511-21 - 47513-21
 21 cm, 8 1/4"



47514-16
 fein, fino
 fine, fina



47516-16
 grob, coarse,
 gruesa, grossa

JOSEPH(LEWIS)
 47514-16 - 47516-16
 18 cm, 7"

Nasenraspeln
 Nasal Rasps
 Escofinas nasales
 Raspa nasale

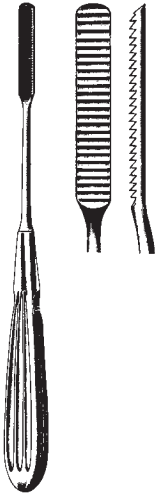

MALTZ (COTTLE)
 47518-21
 21 cm, 8 1/4"

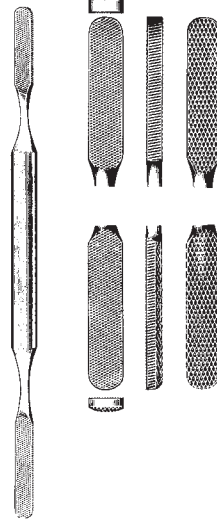

FOMON
 47520-21
 21 cm, 8 1/4"

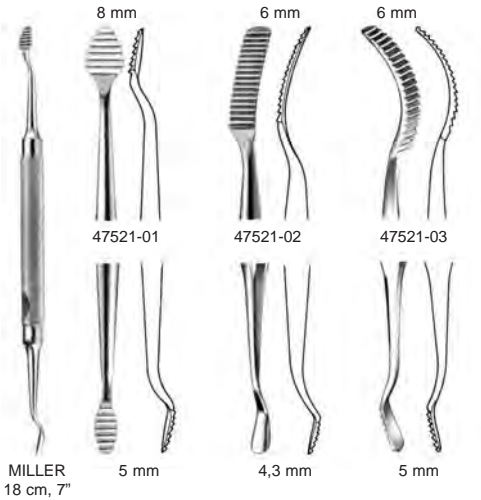

MILLER
 18 cm, 7"

8 mm

47521-01

5 mm

6 mm

47521-02

4,3 mm

6 mm

47521-03

5 mm

Nasenraspeln
 Nasal Rasps
 Escofinas nasales
 Raspa nasale



FOMON

47522-01 - 47522-09 TC
 20 cm, 8"



1



2

Fig. 1/2
 47522-01 TC



3



4

Fig. 3/4
 47522-04 TC



5

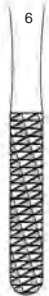

6

Fig. 5/6
 47522-05 TC



7



8

Fig. 7/8
 47522-07 TC



9



10

Fig. 9/10
 47522-09 TC

Nasenraspeln, Nasensägen
 Nasal Rasps, Nasal Saws
 Escofinas nasales, Sierras nasales
 Raspa nasale, Seghe nasale



PEET
 47523-01 —
 47523-02 —
 19 cm, 7 1/2"



GALLAHER
 47526-16 - 47529-16
 16 cm, 6 1/4"



Fig. 1
 47526-16



Fig. 2
 47527-16

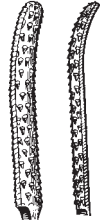

Fig. 3
 47529-16



JOSEPH
 47535-01 47535-02
 17 cm, 6 3/4"



links
 left
 izquierda
 a sinistra



JOSEPH
 19 cm (7 1/2")
 47533-19



rechts
 right
 derecha
 a destra

gerade
 straight
 redo
 retta

Nasenhaken
 Nasal retractor
 Retractores nasales
 Retrattori nasali



COTTLE
 47540-16
 16 cm, 6 1/2"



MASING
 47541-14
 14 cm, 5 1/2"



AUFRICHT
 47542-12
 12 cm, 4 3/4"



AUFRICHT
 47551-16
 16 cm, 6 1/2"



AUFRICHT
 47551-16L
 16 cm, 6 1/2"



MASING-NEIVERT
 47552-16
 16 cm, 6 1/2"

Nasenhaken, Hauthäkchen
 Nasal retractor
 Retractores nasales, Ganchos para la piel
 Retrattori nasali, uncini nasali

10 x 12 mm



COTTLE
 47553-15
 15 cm, 6"



COTTLE
 14,5 cm, 5 3/4"



47554-01



47554-02

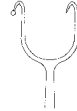

47554-03

3 x 11 mm



KILNER
 47555-08
 8 cm, 3 1/8"

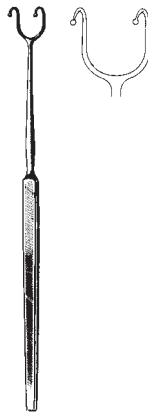

FOMON
 47556-16
 16 cm, 6 1/4"



FOMON
 47557-17
 17 cm, 6 3/4"

Hauthäkchen, Columella Pinzette
 Retractor, Columnella forceps
 Ganchos para la piel, Pinza para columella
 Uncini, Pinzetta columella



FREER
 47558-15
 15 cm, 6"



COTTLE-NEIVERT
 47559-20
 20 cm, 8"



Fig. GILLIES
 1 47560-18
 2 47562-18
 18 cm, 7"



Fig. 1



Fig. 2



LANGE
 47563-22
 23 cm, 9"



COTTLE
 47564-16
 16 cm, 6 1/2"



COTTLE
 47565-10
 10 cm, 4"



CONVERSE
 47566-12
 12 cm, 4 3/4"

Septumrichtzangen, Küretten
 Septum Straightening Forceps, Curettes
 Pinza para enderezar el tabique nasal, curetas
 Pinza per la plastica nasale, Curette



ASCH
 47571-23
 23 cm, 9"



WALSHAM
 47572-23 - 47575-23
 23 cm, 9"



47572-23
 gerade
 straight
 recta
 retta

47573-23
 links
 left
 izquierda
 a sinistra

47575-23
 rechts
 right
 derecha
 a destra



FAULKNER
 47601-21
 21 cm, 8 1/4"



COAKLEY
 47607-01 - 47607-06
 17 cm, 6 3/4"



47607-01
 Fig. 1



47607-02
 Fig. 2



47607-03
 Fig. 3



47607-04
 Fig. 4



47607-05
 Fig. 5



47607-06
 Fig. 6

Ringmesser, Innendurchmesser
 Adenoid Curettes, inner diameter
 Cuchillos para vegetaciones adenoides, camera diámetro
 Coltelli per vegetazioni adenoidi, interno diametro

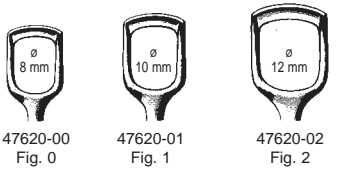

47620-00
Fig. 0

47620-01
Fig. 1

47620-02
Fig. 2

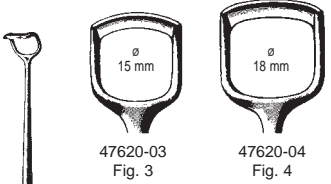

47620-03
Fig. 3

47620-04
Fig. 4

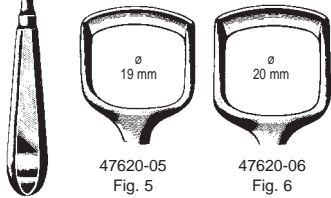

47620-05
Fig. 5

47620-06
Fig. 6

BECKMANN
47620-01 - 47620-06
22 cm, 8 3/4"

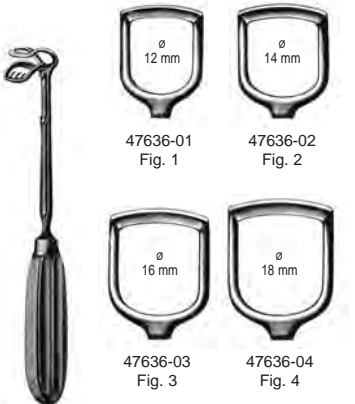

47636-01
Fig. 1

47636-02
Fig. 2

47636-03
Fig. 3

47636-04
Fig. 4

St. CLAIR-THOMSON
47636-01 - 47636-04
21 cm, 8 1/2"

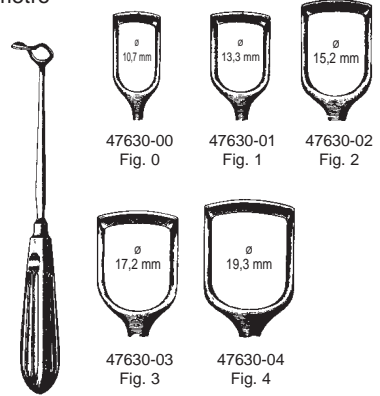

47630-00
Fig. 0

47630-01
Fig. 1

47630-02
Fig. 2

47630-03
Fig. 3

47630-04
Fig. 4

BARNHILL
47630-01 - 47630-04
21 cm, 8 1/4"



LAFORCE
47641-01 - 47643-03
25 cm, 10"

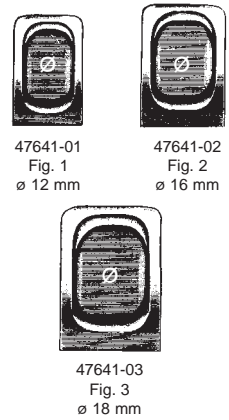

47641-01
Fig. 1
ø 12 mm

47641-02
Fig. 2
ø 16 mm

47641-03
Fig. 3
ø 18 mm

Ersatzklingen allein, gelocht
 Spare blades, perforated
 Hojas de repuesto, perforadas
 Lame di ricambio, forate

Fig. 1 47642-01
 Fig. 2 47642-02
 Fig. 3 47642-03

Zungenspatel, Wangen- und Lippenhalter
 Tongue Depressors, Cheek and Lip Retractors
 Baja-lenguas, Separadores para labios y mejillas
 Abbassalingua, Divaricatori per guance e labbra

Holz
 wood
 madera
 legno



49102-16
 16 cm, 6 1/4"
 Pack. à 100



MAYO
 49103-17
 17 cm, 6 3/4"



KROENIG
 49104-15
 15 cm, 6"



FRENZEL
 49105-16
 16,5 cm, 6 1/2"



49106-01
 14,5 cm, 5 3/4"



49106-02
 14,5 cm, 5 3/4"



BRUENINGS
 49107-19
 19 cm, 7 1/2"



CAWOOD-MINNESOTA
 49108-15
 15 cm, 6"



BUCHWALD
 49109-19
 19 cm, 7 1/2"

Zungendrucker
 Tongue Depressors
 Baja-lenguas
 Abassalingua



MORITZ-SCHMIDT
 49110-19
 19 cm, 7 1/2"

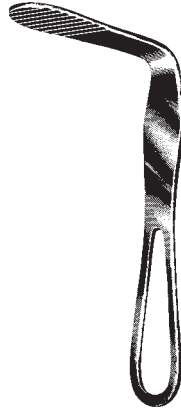

HARTMANN
 49111-15
 15 cm, 6"



49115-01
 Fig. 1
 14 cm, 5 1/2"



49115-02
 Fig. 2
 15 cm, 6"

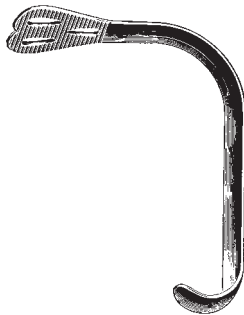

WIEDER
 49115-01 - 49115-02

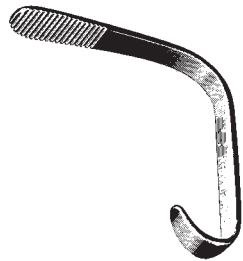

ANDREW
 49117-11
 11 cm, 4 3/8"

Zungendrucker, Wangen- und Lippenhalter, Zungenzangen
 Tongue Depressor, Cheek and Lip Retractor, Tongue Holding Forceps
 Baja-lenguas, Separadores para labios y mejillas, Pinza tira-lenguas
 Abassalingua, Divaricatori per guance e labbra, Pinza tiralingua



TOBOLD
 49119-14
 14,5 cm, 5 3/4"

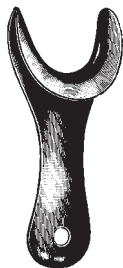

49230-11
 11 cm, 4 3/8"



STERNBERG
 49231-12 12 cm, 4 3/4"
 49231-14 14 cm, 5 1/2"
 49231-16 16 cm, 6 1/4"



49235-19
 19 cm, 7 1/2"

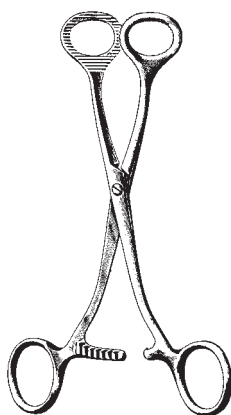

COLLIN
 49250-16 16 cm, 6 1/4"
 49250-18 18 cm, 7"



YOUNG
 49255-16
 16 cm, 6 1/4"



49255-99
 Ersatzgummibacken (Paar)
 Spare (Pair)
 Repuesto (pareja)
 Ricambio (coppia)

Mundsperrer
 Mouth Gags
 Abre-Bocas
 Apribocca

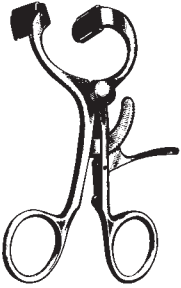

DOYEN-JANSEN (MOLT)
 49265-12
 12 cm, 4 3/4"

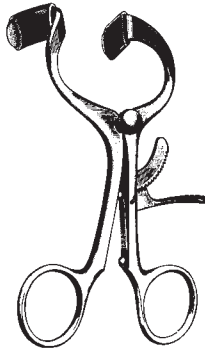

DOYEN-JANSEN (MOLT)
 49265-14
 14 cm, 5 1/2"

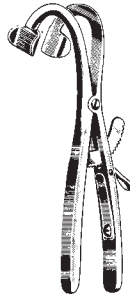

DENHART
 49267-12
 12 cm, 4 3/4"

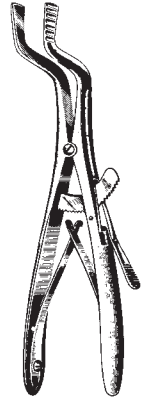

ROSER-KOENIG
 49270-16 16 cm, 6 1/4"
 49270-19 19 cm, 7 1/2"

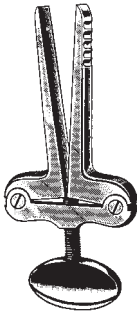

HEISTER
 49272-13
 13 cm, 5 1/8"

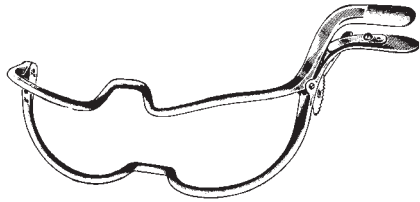

JENNINGS
 49274-09 9 cm, 3 1/2"
 49274-11 11 cm, 4 3/8"
 49274-13 13 cm, 5 1/8"
 49274-15 15 cm, 6"

Zungenspatel, Mundsperrer
 Tongue depressor, Mouth Gags
 Baja-lengua, Abrebocas
 Abbassalingua, Apribocca



linke Seite
 left side
 izquierda
 lato sinistro

rechte Seite
 right side
 derecha
 lato destro

RING

- | | | |
|----------|--------|----------|
| 49287-02 | Fig. 2 | 49288-02 |
| 49287-03 | Fig. 3 | 49288-03 |
| 49287-04 | Fig. 4 | 49288-04 |
| 49287-05 | Fig. 5 | 49288-05 |

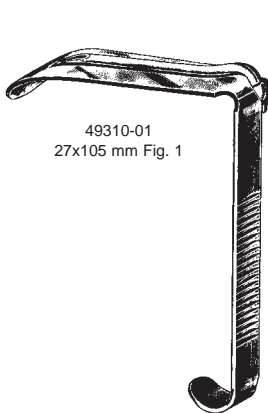
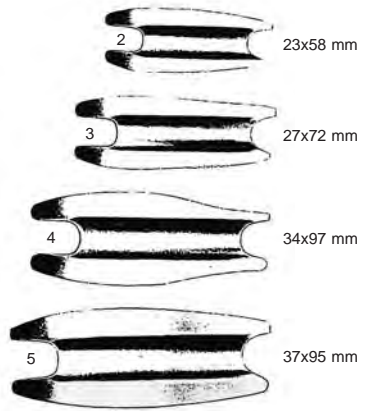

49310-01
 27x105 mm Fig. 1

DAVIS-BOYLE
 49310-00
 compl.



49310-02
 25x90 mm Fig. 2



49310-03
 25x75 mm Fig. 3



49310-04
 22x60 mm Fig. 4



49310-05
 20x25 mm Fig. 5

49310-08 Silikoneinlagen/Silicone pads
 inserto de silicona/inserto in silicone

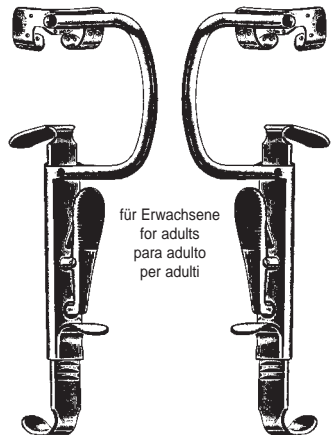

für Erwachsene
 for adults
 para adulto
 per adulti

49310-10
 Sperrer allein, links
 Gag only, left
 Abre-boca suelta, izquierda
 Apribocca solo, sinistra

49310-12
 Sperrer allein, rechts
 Gag only, right
 Abre-boca suelta, derecha
 Apribocca solo, destra

Mundsperrer
 Mouth Gags
 Abre-Bocas
 Apribocca



49315-01
 Fig. 1

49315-02
 Fig. 2

49315-03
 Fig. 3

KILNER-DOUGHTY
 49315-00
 compl.

49315-10
 Sperrer allein
 Gag only
 Abre-boca solo
 Apribocca solo

49317-00 DINGMANN, komplett
 mit 3 auswechselbaren Zungendrucker,
 2 seitliche Wangenhaken und 2 Zahnhaken

with 3 interchangeable tongue depressors,
 2 rotating cheek holders
 2 movable tooth hooks and thread guide

con 3 baja lenguas intercambiables,
 2 valvas giratorias p. los labios,
 2 ganchos graduables

con 3 depressori intercambiabili,
 2 valve laterali rotative
 2 uncini a denti mobile



DINGMANN
 49317-10
 Sperrer allein, Gag only
 Abre-boca solo, Apribocca solo



Mundsperrer
Mouth Gag
Abre-bocas
Apribocca

49320-20
Silikon-Schlauch
Silicon Tubing
tubo de silicona
tubo in silicone

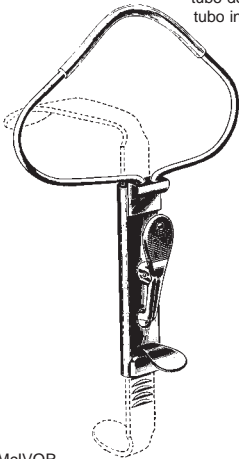

McIVOR
49320-00
compl.

49320-10

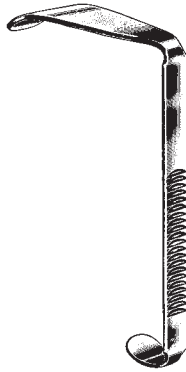

49320-01
27x95 mm Fig. 1



49320-02
22x85 mm Fig. 2



49320-03
22x70 mm Fig. 3



DAVIS-MEYER
49340-00

Zungenspatel
Tongue blades
Baja-lenguas
Abbassalingua

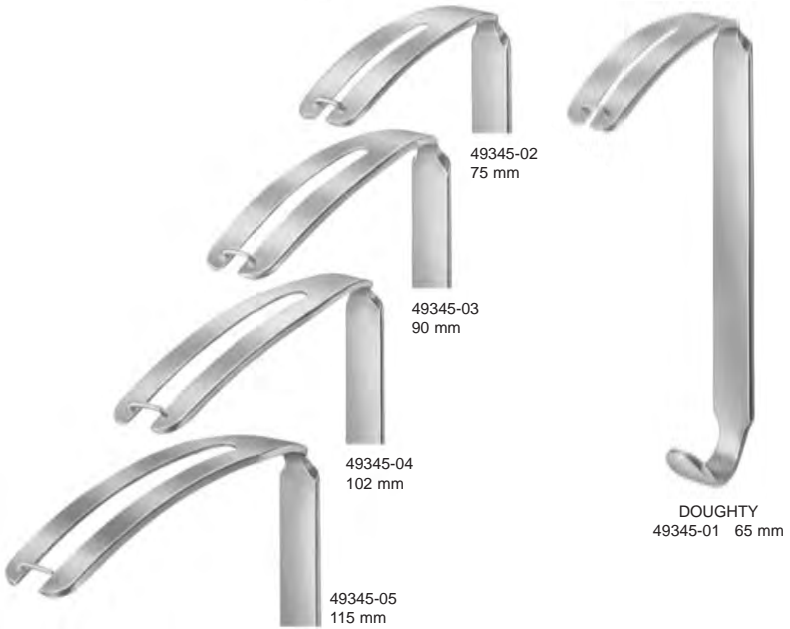
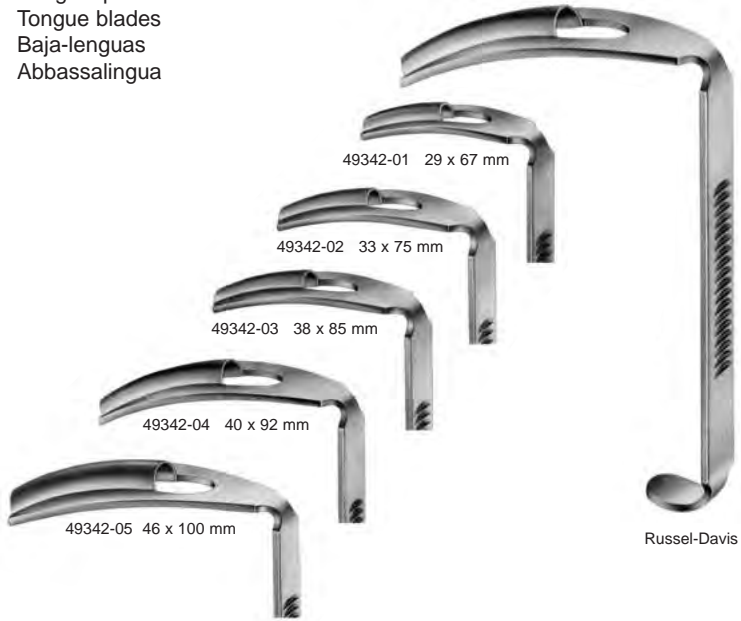

Mundkeil, Repositionszangen, Bruststütze
 Oral Wedges, Disimpaction Forceps, Chest Support
 Pinzas para reposiciones, Soporte de pecho
 Pinze per riposizione, Supporto per petto

Holz
 wood
 madera
 legno



MAUNDER
 49360-10



NEGUS
 49400-01



links
 left side
 izquierda
 lato sinistro

ROWE

49501-22 22,5 cm, 8.9"
 49501-23 23,5 cm, 9 1/4"
 49501-24 24,0 cm, 9 1/2"

Baby, baby, bebé, lattante
 Kind, child, niño, bambino
 Erwachs., adult, adulto



rechts
 right side
 derecha
 lato destro

ROWE

49503-22 22,5 cm, 8.9"
 49503-23 23,5 cm, 9 1/4"
 49503-24 24,0 cm, 9 1/2"

Wundhaken für Mund-Kiefer-Gesicht
Retractors for Mouth-, Jaw- and Face Surgery
Separadores para cirugía plástica
Divaricatori per chirurgia plastica

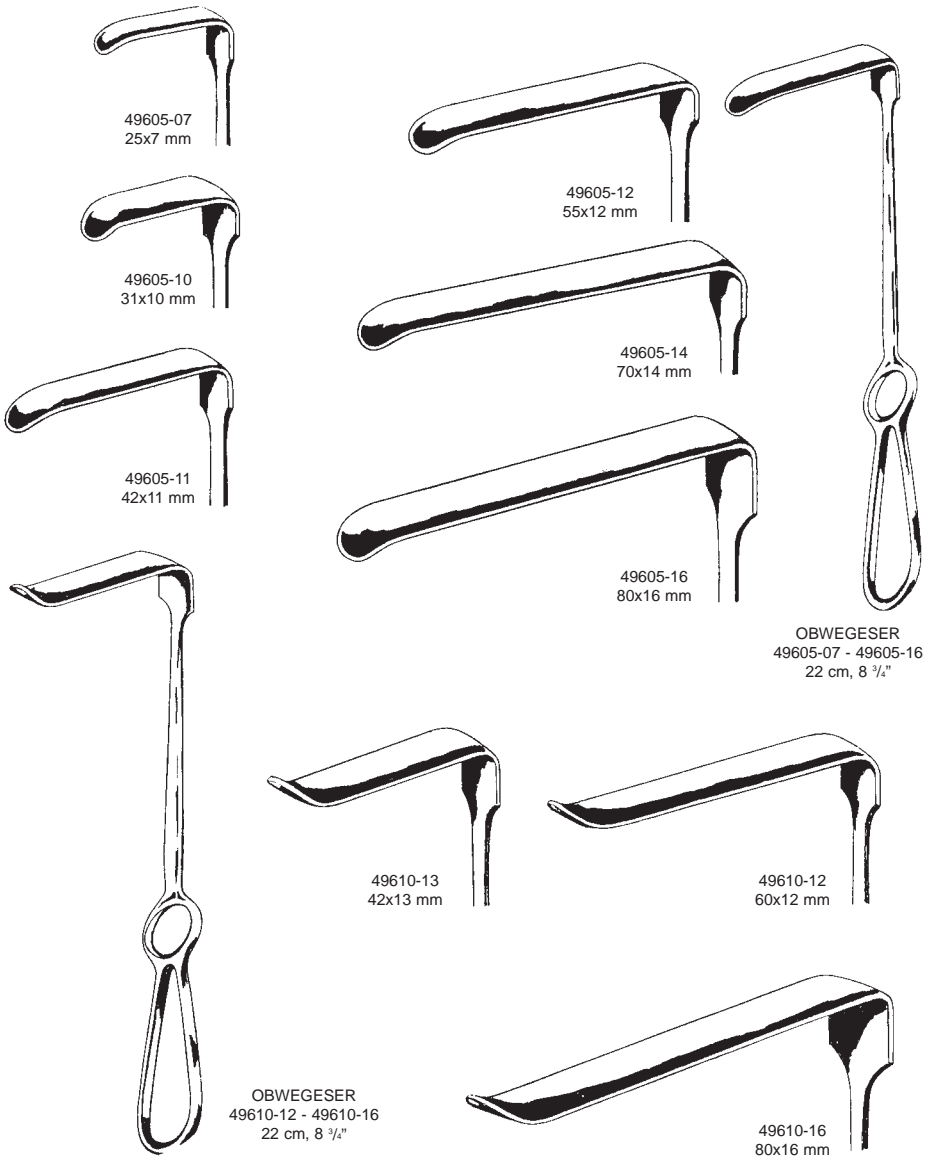

Wundhaken für Mund-Kiefer-Gesicht
 Retractors, Raspatories for Mouth-, Jaw- and Face Surgery
 Separadores Periostótomos para cirugía plástica
 Divaricatori, Periostotomi per chirurgia plastica

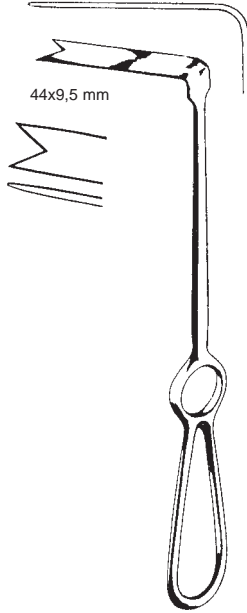

SPINA-NASALIS
 49613-10
 22 cm, 8 3/4"

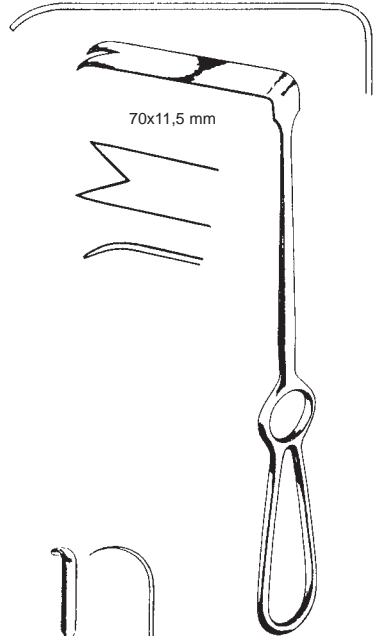

RAMUS
 49615-12
 22 cm, 8 3/4"



OBWEGESER
 49620-15
 15,5 cm, 6"

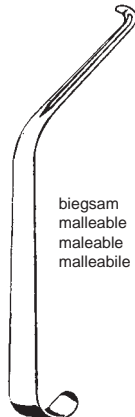

OBWEGESER
 49623-16
 16 cm, 6 1/4"

biegsam
 malleable
 maleable
 malleabile



OBWEGESER
 49627-01
 21 cm, 8 1/4"

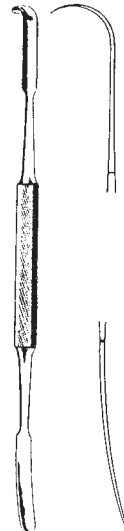

OBWEGESER
 49630-02
 20,5 cm, 8"

Raspatorien
Periosteal Elevators
Periostótomos
Periostotomi



OBWEGESER
49635-18
17,5 cm, 7"



OBWEGESER
49640-05 - 49640-09
20 cm, 8"

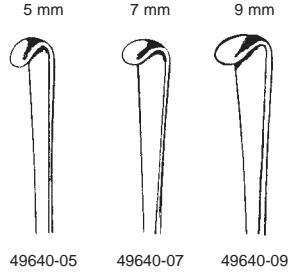

OBWEGESER
49650-06 - 49650-11
17,5 cm, 7"



49650-06



49650-07



49650-09



49650-11

Raspatorien, Osteotom, Unterkieferhaken, Ahle
 Raspatories, Osteotome, Retractors for Mouth-, Jaw- and Face Surgery, Awls
 Periostótomos, Osteotomos, Separadores para cirugía plástica, Agujas
 Periostotomi, Osteotomo, Divaricatori per chirurgia plastica, Aghi



DINGMAN
 49660-18
 18 cm, 7"



OBWEGESER
 49665-24
 23,5 cm, 9 1/4"



HARGIS
 49670-19
 19 cm, 7 1/2"



OBWEGESER
 49670-23
 23 cm, 9"

Intraorale Retraktoren
 Intra Oral Retractors
 Separadores intra orales
 Retrattori intraorali

26,5 / 16 mm



49671-01
 21 cm, 8 1/4"
 rechts
 right
 droite
 destra

26,5 / 16 mm



49671-02
 21 cm, 8 1/4"
 links
 left
 gauche
 sinistra

26,5 / 16 mm



49671-01 CL
 24,5 cm, 9 3/4"
 rechts
 right
 droite
 destra

26,5 / 16 mm



49671-02 CL
 24,5 cm, 9 3/4"
 links
 left
 gauche
 sinistra

Raspatorien
 Periosteal Elevators
 Legras
 Elevatori per periostio



HARGIS
 23 cm, 9"



49673-01
 6,5 mm
 rechts
 right
 derecha
 destra



49673-02
 9 mm
 rechts
 right
 derecha
 destra



49673-03
 6,5 mm
 links
 left
 izquierda
 sinistra

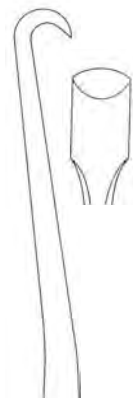

49673-04
 9 mm
 links
 left
 izquierda
 sinistra

Raspatorien, Ahle, Haken
 Raspatories, Awls, Retractors for Mouth-, Jaw- and Face Surgery
 Periostótomos, Agujas, Separadores para cirugía plástica
 Periostotomi, Aghi, Divaricatori per chirurgia plastica



OBWEGESER
 49675-18
 18 cm, 7"

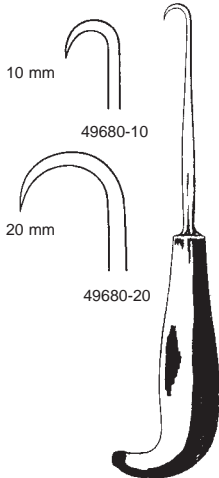

19 cm, 7 1/2"



DINGMAN
 49685-21
 21 cm, 8 1/4"

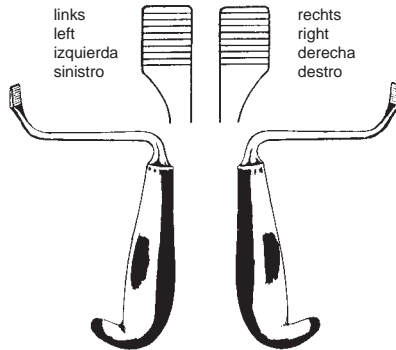

TESSIER
 49691-15
 15 cm, 6"

TESSIER
 49692-15
 15 cm, 6"

Intraorale Retraktoren
Intra Oral Retractors
Separadores intra orales
Retrattori intraorali



Sagittalspreizer
Sagittal Split Separators
Separadores sagitales
Separatori sagittali



SMITH
49695-01
18,5 cm, 7 1/4"
9 mm
rechts
right
derecha
destra



SMITH
49695-02
18,5 cm, 7 1/4"
9 mm
links
left
izquierda
sinistra

Unterkieferkörperhaken
Mandibular Body Retractor
Separador para el cuerpo mandibular
Separatore per il corpo mandibolare



HARGIS
49696-18
18 cm, 7"

Osteotome
Osteotome
Osteótomos
Osteotomi



49700-01
21,5 cm, 8 1/2"



49700-02
21,5 cm, 8 1/2"

Blattosteotom
Blade Osteotomes
Osteótomos de hoja
Osteotomo a lama



OBWEGESER
22 cm, 8 3/4"



49705-08
8 mm



49705-12
12 mm



49705-16
16 mm

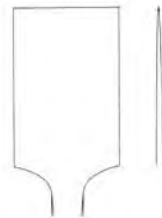

49705-20
20 mm

Osteotome
Osteotome
Osteótomos
Osteotomi

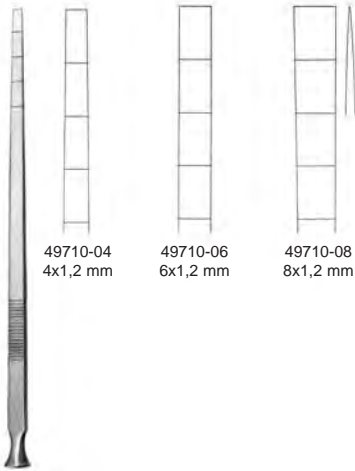

EPKER
18 cm, 7"

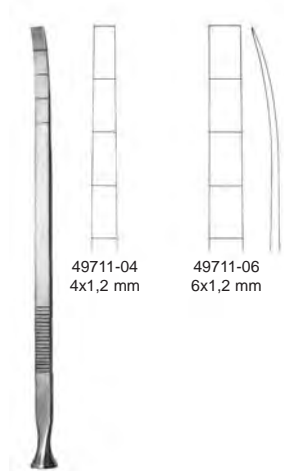

EPKER
18 cm, 7"

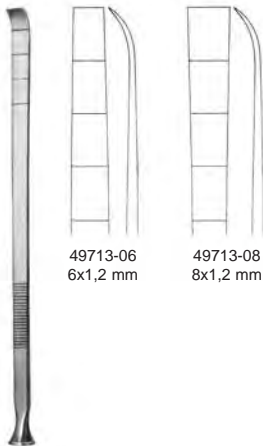

EPKER
18 cm, 7"

Wundhaken, Tonsillen-Elevatoren, Tamponstopfer
 Retractors, Tonsil-Elevators, Gauze packer
 Separadores, Elevadores para amígdalas, Tamponeador
 Divaricatori, Elevatori, Tamponatore

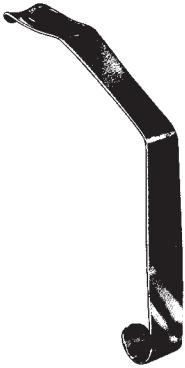

LOVE 15 cm, 6"
 51103-18 18 mm
 51103-20 20 mm
 51103-22 22 mm



HOFER
 51109-24
 24 cm, 9 1/2"



NAGER
 51111-23
 23 cm, 9"



HURD
 51131-22
 22 cm, 8 1/4"



LOPEZ-REINKE
 51133-23
 23 cm, 9"



YANKAUER
 51134-21
 21 cm, 8 1/4"



51135-01



HENKE
 23 cm, 9"



51135-02



CARPENTER
 51139-25
 25 cm, 10"



CARPENTER
 51143-24
 24 cm, 9 1/2"



LUNIATSCHEK
 51151-19
 19 cm, 7 1/2"



Tonsillen-Nadeln, Tonsillen-Messer
 Tonsil Needles, Tonsil-Knives
 Aguja para suturas de amígdalas, Bisturios para amígdalas
 Aghi per tonsille, Coltelli per tonsille

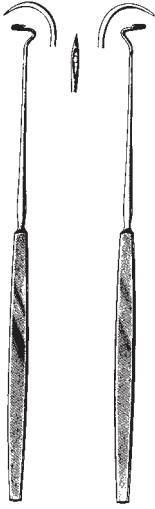

DUPUY-WEISS
 51165-22 51167-22
 22 cm, 8 1/4"



CLAUS
 51168-23
 23 cm, 9"



CLAUS-EICKEN
 51169-23
 23 cm, 9"



NAGER
 51170-24
 24 cm, 9 1/2"



FISHER
 51171-22
 22,5 , 9"



ABRAHAM
 51172-19
 19 cm, 7 1/2"



ABRAHAM
 51173-21
 21 cm, 8 1/4"



CANFIELD
 51174-21
 21 cm, 8 1/4"



BRUENINGS
 51177-23
 23 cm, 9"



DOUGLAS
 51178-21
 21 cm, 8 1/4"



DOUGLAS
 51179-17
 17 cm, 6 3/4"

Tonsillenzange
 Tonsil Seizing Forceps
 Pinzas para coger las amígdalas
 Pinze per tonsille

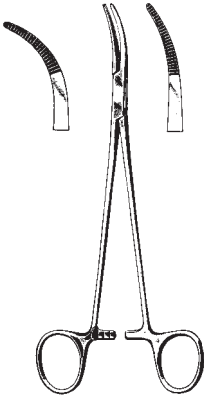

19 cm, 7 1/2"
 SAWTELL SCHNIDT
 51181-19 51183-19

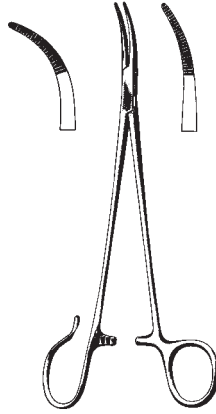

19 cm, 7 1/2"
 SAWTELL SCHNIDT
 51185-19 51187-19

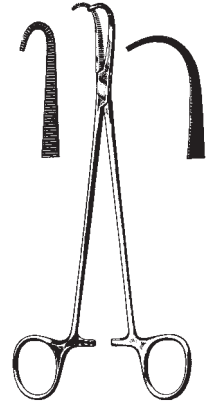

19 cm, 7 1/2"
 NEGUS NEGUS
 51191-19 51193-19

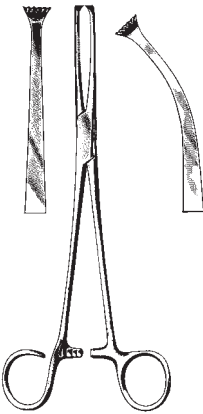

19 cm, 7 1/2"
 COLVER
 51202-19 51203-19

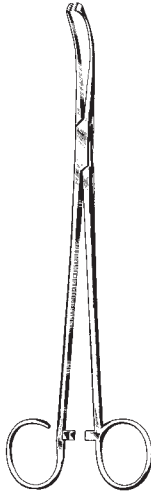

WHITE
 51205-18 18 cm, 7"
 51205-23 23 cm, 9"



BALLENGER
 51207-21
 21,5 cm, 8 1/2"

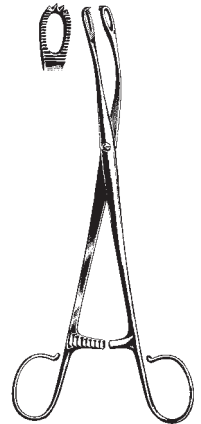

BLOHMKE
 51209-20
 20 cm, 8"

Tonsillen-Zangen u. -Pinzetten, Tonsillen-Kompressoren, Tonsillen-Schnürer
 Tonsil-Forceps, Tonsil-Snares
 Pinzas, Compresores para amígdalas, Cierra-nudos para amígdalas
 Pinze, Compresori per tonsille, Serranodi per tonsille



ABRAHAM
 51210-20
 20 cm, 8"

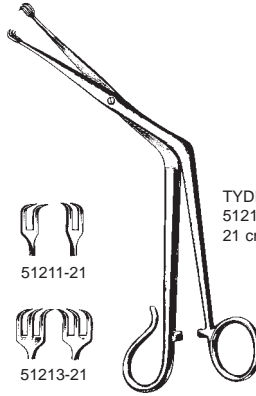

51211-21

51213-21

TYDING
 51211-21 - 51213-21
 21 cm, 8 1/4"

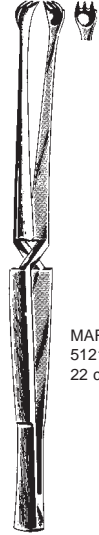

MARSCHIK
 51219-22
 22 cm, 8 3/4"



EVES
 51250-28
 28 cm, 11"



EVES
 51252-28
 28 cm, 11"



BRUENINGS
 51256-28
 28 cm, 11"

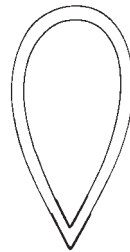

51257-40 40 mm
 51257-50 50 mm
 Pack of 100 pcs



51259-03 0,3 mm
 51259-04 0,4 mm
 51259-05 0,5 mm
 Pack of 12 pcs

Tonsillotom
Tonsillectomes
Amigdalótomos
Tonsillotomi

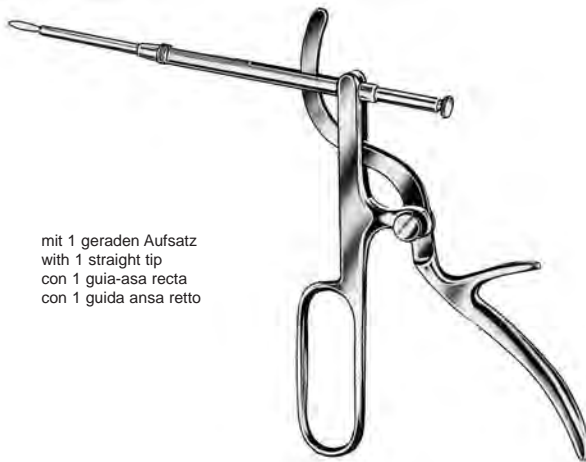

mit 1 geraden Aufsatz
with 1 straight tip
con 1 guida-asa recta
con 1 guida ansa retto

TYDING
51260-00

Tonsillotom, Spritzen, Septum Nadeln
 Tonsillectomes, Syringes, Septum needles
 Amigdalótomos, Jeringas, Septum aguja
 Tonsillotomi, Siringhe, Septum aghi

Aufsatz allein
 blade only
 hoja sola
 lama sola

51270-01



1

51270-02

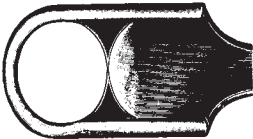

2

51270-03



3

51270-04
 Handgriff allein
 Handle only
 mango para
 manipolo solo

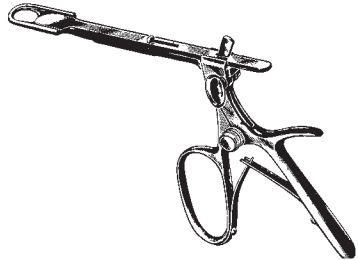

SLUDER-BALLENGER
 51270-00
 mit 3 Aufsätzen
 with 3 blades
 con 3 hojas
 con 3 lame



51291-00
 2,5 mm Ø

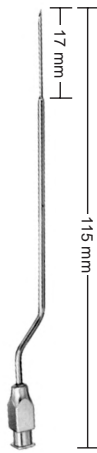

51293-00
 0,8 mm Ø

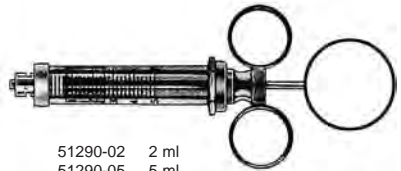

51290-02 2 ml
 51290-05 5 ml
 51290-10 10 ml
 51290-20 20 ml



51292-00

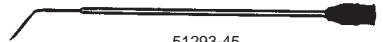

51293-45
 45°

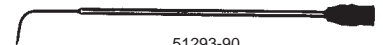

51293-90
 90°

Septum-Schere, Kehlkopfpolypenzangen, Deckelhalter
 Septum-Scissors, Laryngeal Polypus Forceps, Epiglottis Retractor
 Tijeras para septo, Pinzas para pólipos laríngeos, Depresor para epiglottis
 Forbice per il setto nasale, Pinze per polipi laringei, Depressore per epiglottide



KILLIAN
 53102-20
 20 cm, 8"



53101-22



53103-22



JACKSON
 53101-22 - 53103-22
 22 cm, 8 1/2"

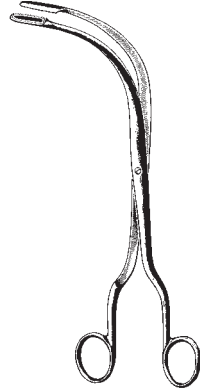

FRAENKEL
 53111-18
 18 cm, 7"

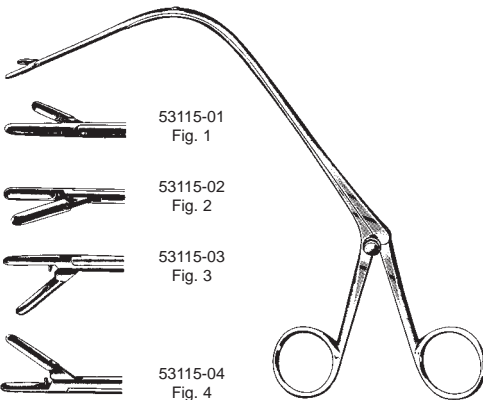

53115-01
 Fig. 1

53115-02
 Fig. 2

53115-03
 Fig. 3

53115-04
 Fig. 4

JURASZ
 53115-01 - 53115-04
 23 cm, 9"



REICHERT
 53121-24
 24 cm, 9 1/2"

Universalgriffe, Verlängerungsrohre, Aufsätze
 Universal Handles, Interchangeable Tips, Tips
 Mangos universales y Tubos de extension, Puntas
 Manici universali e Tubi di prolungamento, Terminale laringeo



BRUENINGS
 53131-20
 20 cm, 8"



HUBER
 53130-00

BRUENINGS
 53132-20 20 cm, 8" 53132-50 50 cm, 19 3/4"
 53132-30 30 cm, 11 3/4" 53132-60 60 cm, 23 1/2"
 53132-40 40 cm, 15 3/4"



FRAENKEL
 53150-00



SEIFERT
 53152-00



FRAENKEL
 53154-00



SCHEINMANN
 53155-00



SCHEINMANN
 53157-00



BRUENINGS
 53158-02 - 53158-03

53160-02

53160-03



BRUENINGS
 53160-02 - 53160-03



LANGE
 53162-00

53164-01

53164-02



KRAUSE
 53164-01 - 53164-02



KRAUSE
 53166-00



SCHUMACHER
 53170-00



BARACANI
 53175-00

53177-01

53177-02



CORDES
 53177-01 - 53177-02

Broncho-Oesophagoskopiezangen, Kehlkopfspiegel, Griffe
 Broncho-Esophagoscopy Forceps, Laryngeal Mirrors, Handles
 Pinzas para bronco-esofagoscopia, Espejos laringeos, Mangos
 Pinze per bronco-esofagoscopia, Specchi laringei, Manici

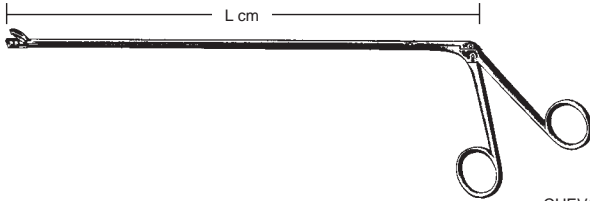

CHEVALIER-JACKSON
 53230-01 - 53260-08



cm	Fig. 1	Fig. 2	Fig. 3	Fig. 4	Fig. 5	Fig. 6	Fig. 7	Fig. 8
30/11 3/4"	53230-01	53230-02	53230-03	53230-04	53230-05	53230-06	53230-07	53230-08
40/15 3/4"	53240-01	53240-02	53240-03	53240-04	53240-05	53240-06	53240-07	53240-08
50/19 3/4"	53250-01	53250-02	53250-03	53250-04	53250-05	53250-06	53250-07	53250-08
60/23 1/2"	53260-01	53260-02	53260-03	53260-04	53260-05	53260-06	53260-07	53260-08

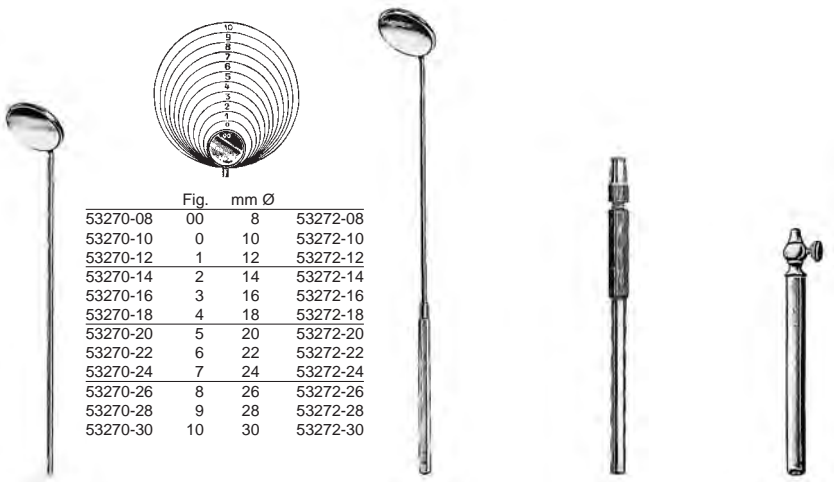

Fig.	mm Ø	
53270-08	00	8
53270-10	0	10
53270-12	1	12
53270-14	2	14
53270-16	3	16
53270-18	4	18
53270-20	5	20
53270-22	6	22
53270-24	7	24
53270-26	8	26
53270-28	9	28
53270-30	10	30

53270-08 - 53270-30

53272-08 - 53272-30

53274-12

53276-10

Mikro-Rohrschaftzangen
 Micro Laryngeal Forceps
 Pinzas para la micro-cirugía de la laringe
 Pinze ad asta tubolare per microchirurgia

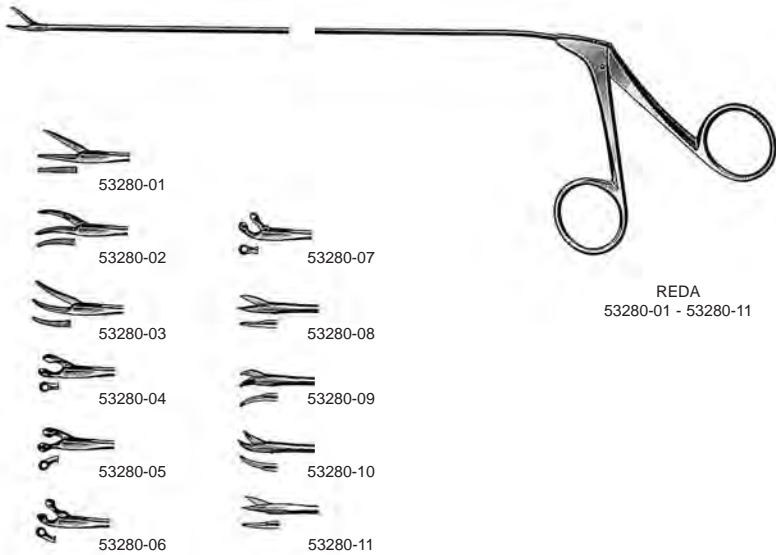

REDA Mikro-Rohrschaftzangen 22 cm (8 3/4")

- 53280-01 gerieftes Maul, gerade 1,5 x 10 mm
- 53280-02 gerieftes Maul, links gebogen 1,5 x 8,5 mm
- 53280-03 gerieftes Maul, rechts gebogen 1,5 x 8,5 mm
- 53280-04 Löffelmaul, gerade 2,5 mm
- 53280-05 Löffelmaul, links abgewinkelt 2,5 mm
- 53280-06 Löffelmaul, rechts abgewinkelt 2,5 mm
- 53280-07 Löffelmaul, aufwärts abgewinkelt 2,5 mm
- 53280-08 Schere, gerade, vertikal
- 53280-09 Schere, links gebogen
- 53280-10 Schere, rechts gebogen
- 53280-11 Schere, horizontal schneidend, gerade

REDA Pinza microlaringea 22 cm (8 3/4")

- 53280-01 boca estriada recta 1,5 x 10 mm
- 53280-02 boca estriada curva a la izquierda 1,5 x 8,5 mm
- 53280-03 boca estriada curva a la derecha 1,5 x 8,5 mm
- 53280-04 boca redonda cortante recta 2,5 mm Ø
- 53280-05 boca redonda cortante angulada a la izquierda 2,5 mm Ø
- 53280-06 boca redonda cortante angulada a la derecha 2,5 mm Ø
- 53280-07 boca redonda cortante angulada hacia arriba 2,5 mm Ø
- 53280-08 Tijera recta corte vertical
- 53280-09 Tijera curva a la izquierda
- 53280-10 Tijera curva a la derecha
- 53280-11 Tijera recta corte horizontal

REDA Micro-Laryngeal Forceps 22 cm (8 3/4")

- 53280-01 Grasping tip, straight, serrated, 1,5 x 10 mm
- 53280-02 Grasping tip, curved to left, serrated, 1,5 x 8,5 mm
- 53280-03 Grasping tip, curved to right, serrated, 1,5 x 8,5 mm
- 53280-04 Cup forceps, straight, 2,5 mm
- 53280-05 Cup forceps, angled to left, 2,5 mm
- 53280-06 Cup forceps, angled to right, 2,5 mm
- 53280-07 Cup forceps, angled up, 2,5 mm
- 53280-08 Scissors, straight, vertical
- 53280-09 Scissors, curved to left
- 53280-10 Scissors, curved to right
- 53280-11 Scissors, straight, horizontal

REDA Pinze ad asta tubolare per microchirurgia 22 cm (8 3/4")

- 53280-01 morsi zigrinati, retti, 1,5 x 10 mm
- 53280-02 morsi zigrinati, curvi a sinistra, 1,5 x 8,5 mm
- 53280-03 morsi zigrinati, curvi a destra, 1,5 x 8,5 mm
- 53280-04 morsi a forma di cucchiaino rotondo retto, 2,5 mm
- 53280-05 morsi a forma di cucchiaino rotondo angolati a sinistra, 2,5 mm
- 53280-06 morsi a forma di cucchiaino rotondo angolati a destra, 2,5 mm
- 53280-07 morsi a forma di cucchiaino rotondo angolati in alto, 2,5 mm
- 53280-08 forbici, rette, taglio verticale
- 53280-09 forbici, curve a sinistra
- 53280-10 forbici, curve a destra
- 53280-11 forbici, rette, taglio orizzontale

Instrumente für Tracheotomie
 Instruments for tracheotomy
 Instrumentos tracheotomia
 Strumenti per la tracheotomia

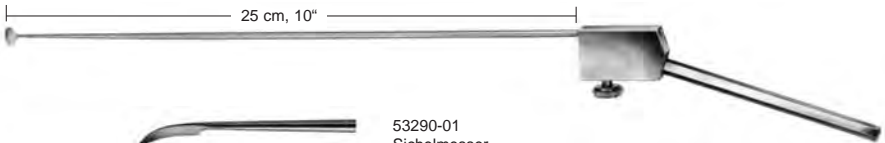

53290-01
 Sichelmesser
 micro-laryngeal sickle
 microlaringeo cuchillo de hoz
 Coltello falcato



53290-02
 Schälmesser, quer
 micro-laryngeal separator oval, horizontal
 microlaringeo separador ovalado, horizontal
 Separatore ovale verticale



53290-03
 Schälmesser, längs
 micro-laryngeal separator oval, vertical
 microlaringeo separador ovalado, vertical
 Separatore ovale orizzontale



53290-04
 Schälmesser, 45° abgewinkelt
 micro-laryngeal round cutting knife, 45° angled
 microlaringeo cuchillo para cortes redondos, 45° angulado
 Separatore angolato 45°



53290-05
 Häkchen, 90° gebogen stumpf
 micro-laryngeal hook 90° angled, blunt
 microlaringeo ganchito 90° angulado, romo
 Uncino angolato 90° smusso



53290-06
 Häkchen, 30° retrograd gebogen
 micro-laryngeal probe, 30° backwards curved blunt with button
 microlaringeo ganchito, 30° curvo retrogrado
 Uncino angolato retrogrado 30°



53290-07
 Fadengabel
 micro-laryngeal ligature adjuster
 microlaringeo horquilla de hilos
 Forchetta da sutura

53290-08
 Handgriff für Stabinstrumente
 Handle for microlaryngeal instruments
 Mango para microlaringeos instrumentos
 Manico per strumenti microlaringei



Tracheal Dilatoren, Trachealhaken, Tracheal-Wundspreizer
 Trachea Dilators, Trachea hooks, Trachel Retractors
 Diladores para la tráquea, Ganchos para traqueotomía, Retractor traqueal
 Dilatori per tracheotomia, Ganci per tracheotomia, Divaricatori tracheali

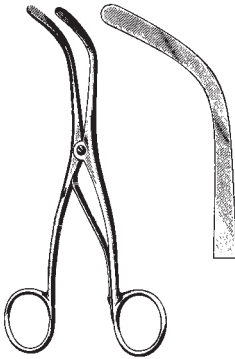

TROUSSEAU-BABY
 55111-13 13 cm, 5 1/8"

TROUSSEAU
 55111-14 14 cm, 5 1/2"

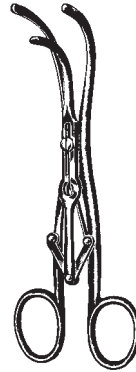

LABORDE
 55113-14
 14 cm, 5 1/2"



BOSE
 55115-07
 7 cm, 2 3/4"



JACKSON
 55116-15
 15 cm, 6"



JACKSON
 55117-17
 17 cm, 6 3/4"

Trachealhaken, Kanüle
 Trachea Hooks, Tubes
 Ganchos para traqueotomía, Cánula
 Ganci per tracheotomia, Cannule



ITERSON
 55118-16 - 55119-16
 16 cm, 6 1/4"



NEWS
 55120-15
 15 cm, 6"

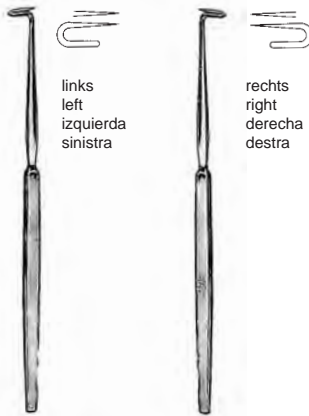

BOSE
 55122-16
 16 cm, 6 1/4"

BOSE
 55124-16
 16 cm, 6 1/4"



WAGENER-MOSHER
 55151-05 5 mm
 55151-07 7 mm
 55151-09 9 mm

Tracheotomie-Besteck
 Tracheotomy Set
 Estuche para Traqueotomía
 Set per Tracheotomia



55200-00

Tracheotomie-Besteck

in Metall-Etui, bestehend aus:

- 1 Griff und 1 Klinge, Fig. 20
- 1 Griff und 1 Klinge, Fig. 23
- 1 anat. Pinzette, 13 cm (5 1/8")
- 2 chir. Pinzetten, 13 cm (5 1/8"), 1x2 Zähne
- 2 Pean-Klemmen, 13 cm (5 1/8")
- 1 Hohlsonde, 13 cm (5 1/8")
- 1 Trachealdilatator
- 2 Trachealhäkchen Iterson stumpf
- 1 Trachealhäkchen Bose scharf, links
- 1 Trachealhäkchen Bose scharf, rechts
- 1 Trachealkanüle Luer Standard, Fig. 3
- 1 Trachealkanüle Luer Standard, Fig. 4
- 1 Reinigungsbürste

Tracheotomy Set

in metal case, consisting of:

- 1 Handle with 1 blade, Fig. 20
- 1 Handle with 1 blade, Fig. 23
- 1 Thumb Forceps, 13 cm (5 1/8")
- 1 Tissue Forceps, 13 cm (5 1/8"), 1x2 teeth
- 2 Pean Artery Forceps, 13 cm (5 1/8")
- 1 Grooved Director, 13 cm (5 1/8")
- 1 Trachea Dilator
- 1 Iterson Trachea Retractors, blunt
- 1 Bose Trachea Retractor, sharp, left hand side
- 1 ditto, right hand side
- 1 Luer Trachea Tube, Standard, Fig. 3
- 1 ditto, Fig. 4
- 1 Cleaning Brush

Estuche para Traqueotomía

en estuche de metal, compuesto de:

- 1 Mango con 1 hoja fig. 20
- 1 Mango con 1 hoja fig. 23
- 1 Pinza de disección, 13 cm (5 1/8")
- 1 Pinza de disección, con 1x2 dientes de ratón, 13 cm (5 1/8")
- 2 Pinzas hemostáticas Pean, 13 cm (5 1/8")
- 1 Sonda acanalada, 13 cm (5 1/8")
- 1 Dilatador traqueal
- 2 Iterson separadores traqueales, romos
- 1 Bose separador traqueal, agudo, lado izquierdo
- 1 idem, lado derecho
- 1 Luer Cánula traqueal, modelo standard, Fig. 3
- 1 idem, Fig. 4
- 1 Cepillo de limpieza

Set per tracheotomia

in scatola di metallo, composto da:

- 1 Manico di bisturi con 1 lama fig. 20
- 1 Manico di bisturi con 1 lama fig. 23
- 1 Pinza per dissezione, cm 13 (5 1/8")
- 1 Pinza per dissezione con denti 1x2, cm 13 (5 1/8")
- 2 Pinze emostatiche Pean, cm 13 (5 1/8")
- 1 Sonda scanalata, cm 13 (5 1/8")
- 1 Dilatatore traqueale
- 2 Uncini tracheali Iterson, smussi
- 1 Uncino tracheale Bose, acuto, lato sinistro
- 1 item, lato destro
- 1 Cannula tracheale Luer standard, Fig. 3
- 1 item, Fig. 4
- 1 Spazzolino per pulire

Tracheal-Kanülen, Schilddrüsenhaken, Sonde, Kropfzange, Muskelklemme
 Tracheal Tubes, Thyroid Gland Retractor, Directors-Enucleators, Goitre Seizing Forceps, Muscular Clamp
 Cánulas traqueales, Separador para la glándula tiroidea, Sondas acanaladas,
 Pinza para coger el bocio, Pinza-clamp para músculos
 Cannule tracheali, Divaricatori per la tiroide, Sonde, Pinze per gozzo, Pinza muscolare



LUER

Neusilber
 German silver
 alpaca
 argentone
 45-90 mm
 55220-04
 55220-05
 55220-06
 55220-07
 55220-08
 55220-09
 55220-10
 55220-11
 55220-12
 55220-13

CHEVALIER-JACKSON

Neusilber
 German silver
 alpaca
 argentone
 45-90 mm
 55240-04
 55240-05
 55240-06
 55240-07
 55240-08
 55240-09
 55240-10
 55240-11
 55240-12
 55240-13

Fig.	Ø mm	Länge des Außenrohrs Length of outer tube Largo de la cánula exterior Lunghezza del tubo esterno
0	4	45
1	5	50
2	6	55
3	7	60
4	8	65
5	9	70
6	10	75
7	11	80
8	12	85
9	13	90

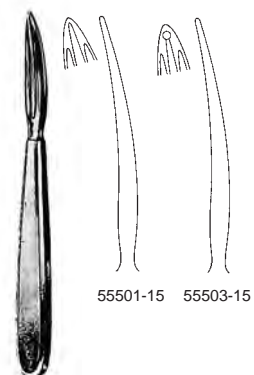

55501-15 55503-15

KOCHER
 55501-15 - 55503-15
 15 cm, 6"



SCHOENBORN
 55511-21
 21 cm, 8 1/4"



LAHEY
 55520-15 15 cm, 6"
 55520-20 20 cm, 8"

MASTIN
 55523-17
 17 cm, 6 3/4"

Rippenscheren, Sternummeißel
 Rib Shears
 Costótomos
 Costotomi



57102-23
 23 cm, 9"



57105-22
 22 cm, 8 3/4"



GLUCK
 57107-22
 22 cm, 8 1/2"

mit ziehendem Schnitt
 with eccentric sliding blade
 con hoja de retroacción
 con lama di retroazione



STILLE
 57111-21
 21 cm, 8 1/4"



CORYLLOS
 57123-35
 35 cm, 13 3/4"

CORYLLOS
 57125-35
 35 cm, 13 3/4"

Rippenscheren, Sternumscheren
 Rib Shears, Sternum Scissors
 Costótomos, Tijeras de esternón
 Costotomi, Forbici per sterno



BETHUNE
 57126-34
 34 cm, 13 1/2"



SAUERBRUCH
 57131-26
 26 cm, 10 1/2"



GIERTZ-STILLE
 57137-27
 27 cm, 10 1/2"



SCHUMACHER
 57138-21
 21 cm, 8 1/4"



SAUERBRUCH-FREY
 57141-36
 36 cm, 14.2"

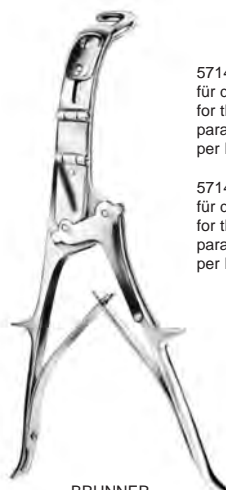

BRUNNER
 57146-28 - 57147-28
 28 cm, 11"

57146-28
 für die rechte Hand
 for the right hand
 para la mano derecha
 per la mano destra

57147-28
 für die linke Hand
 for the left hand
 para la mano izquierda
 per la mano sinistra

Rippensperrer
 Rib Spreaders
 Separadores costales
 Divaricatori costali

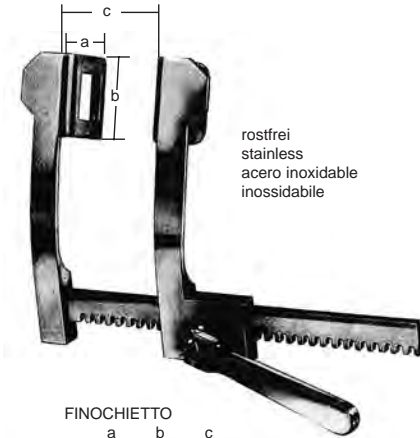

rostfrei
 stainless
 acero inoxidable
 inossidabile

FINOCHIETTO			
	a	b	c
	mm	mm	mm
57210-16	38	44	160
57210-20	52	62	200
57210-25	65	85	250

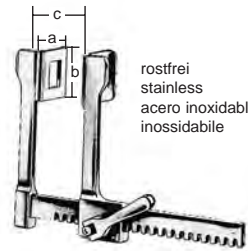

rostfrei
 stainless
 acero inoxidable
 inossidabile

FINOCHIETTO-BABY			
	a	b	c
	mm	mm	mm
57214-75	18	20	75

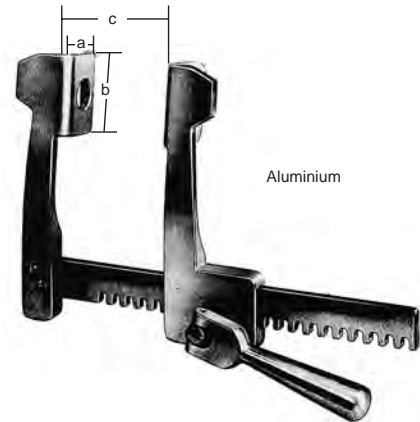

Aluminium

FINOCHIETTO			
	a	b	c
	mm	mm	mm
57230-13	38	44	135
57230-17	52	62	175
57230-18	85	65	175

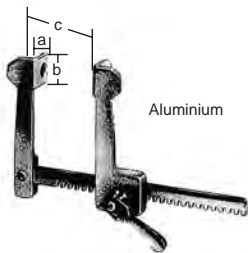

Aluminium

FINOCHIETTO-BABY			
	a	b	c
	mm	mm	mm
57234-75	15	15	75

Rippensperrer
Rib Spreaders
Separadores costales
Divaricatori costali

FINOCHIETTO-BURFORD

	a	b	c
	mm	mm	mm
57236-20	65	62	200
	47	62	
57236-25	65	62	250
	47	62	
57236-30	65	62	300
	47	52	



rostfrei
stainless
acero inoxidable
inossidabile

Erwachsene
Adult Size
para adultos
per adulti

FINOCHIETTO-BURFORD

	a	b	c
	mm	mm	mm
57242-20	47	62	200
	65	62	
57242-25	47	62	250
	65	62	
57242-30	47	62	300
	65	62	



Aluminium

Kinder
Child Size
para niños
per bambini

FINOCHIETTO-BURFORD

	a	b	c
	mm	mm	mm
57244-13	34	42	135
	48	42	



Aluminium

Rippensperrer
 Rib Spreaders
 Separadores costales
 Divaricatori costali

FINOCHIETTO

	a	b	c
	mm	mm	mm
57245-13	14	14	120

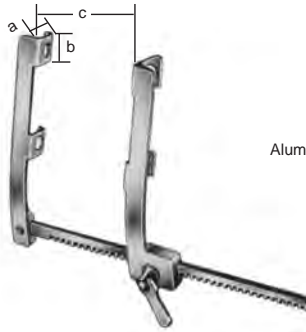

Aluminium

MORSE

	a	b	c
	mm	mm	mm
57246-16	17	22	160

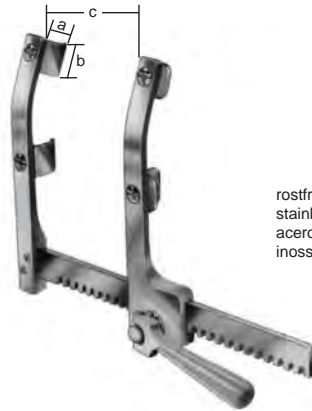
rostfrei
stainless
acero inoxidable
inossidabile

MORSE-FAVALORO

	a	b	c
	mm	mm	mm
57246-21	19	27	210

rostfrei
stainless
acero inoxidable
inossidabile

Ripensperrer
Rib Spreaders
Separadores costales
Divaricatori costali

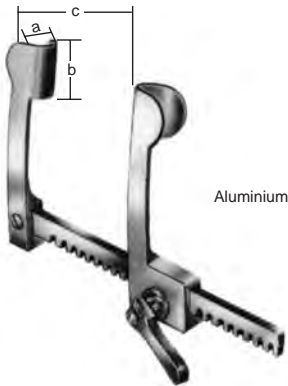

Aluminium

COOLEY-NEONATAL

	a	b	c
	mm	mm	mm
57247-95	12	16	95

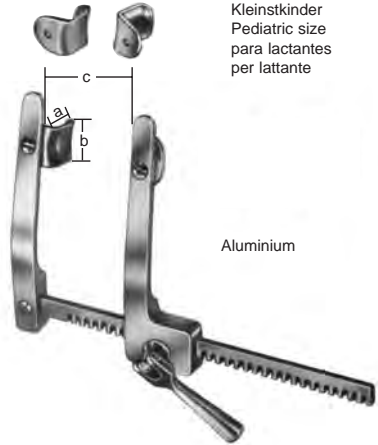

Aluminium

Kleinstkinder
Pediatric size
para lactantes
per lattante

COOLEY

	a	b	c
	mm	mm	mm
57249-01	10	14	90

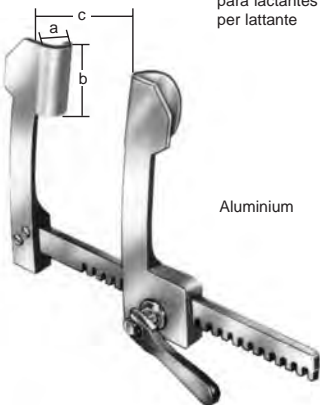

Aluminium

Kleinstkinder
Pediatric size
para lactantes
per lattante

COOLEY

	a	b	c
	mm	mm	mm
57248-14	15	30	140

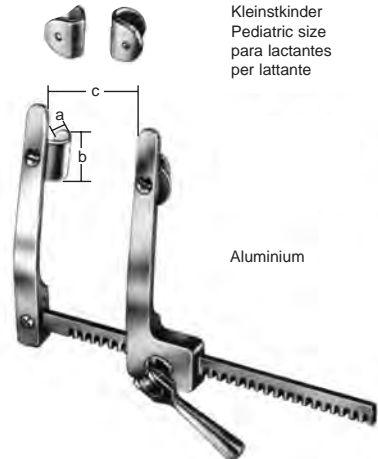

Aluminium

Kleinstkinder
Pediatric size
para lactantes
per lattante

COOLEY

	a	b	c
	mm	mm	mm
57249-02	10	14	90

Rippensperrer rostfrei
 Rib Spreaders stainless
 Separadores costales acero inoxidable
 Divaricatori costali inossidabile

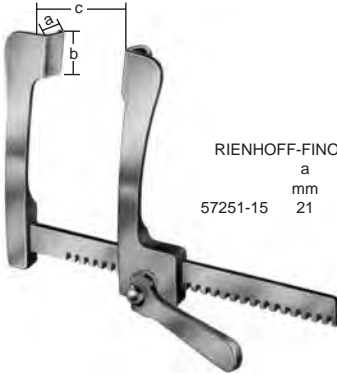

	a	b	c
	mm	mm	mm
57251-15	21	26	150

rostfrei
 stainless
 acero inoxidable
 inossidabile



	a	b	c
	mm	mm	mm
57252-19	27	100	190

rostfrei
 stainless
 acero inoxidable
 inossidabile

Rippensperrer rostfrei
 Rib Spreaders stainless
 Separadores costales acero inoxidable
 Divaricatori costali inossidabile

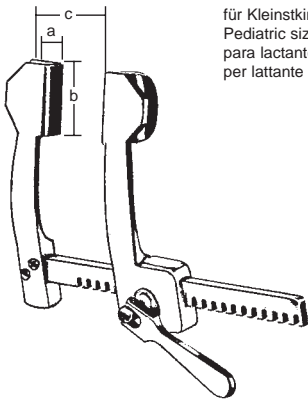

für Kleinstkinder
 Pediatric size
 para lactantes
 per lattante

COOLEY

	a	b	c
	mm	mm	mm
57260-02	16	30	105
57260-03	21	44	150

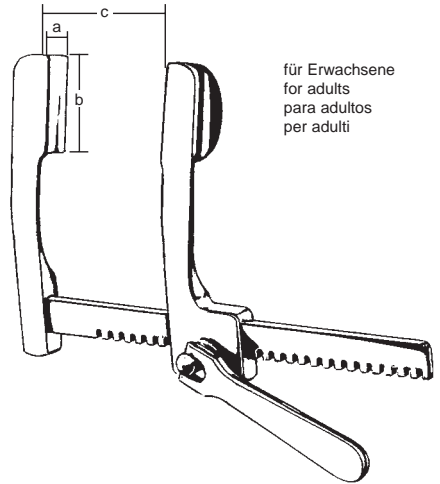

für Erwachsene
 for adults
 para adultos
 per adulti

COOLEY

	a	b	c
	mm	mm	mm
57260-04	37	49	200



HAIGHT

	a	b	c	h
	mm	mm	mm	mm
57260-06	30	30	90	65
57260-09	30	30	90	90



TUFFIER

	a	b	c
	mm	mm	mm
57264-16	50	45	165

Laminectomie-Sperrer
Laminectomy-Retractor
Separadores para laminectomía
Divaricatori Laminectomia



CHERRY

	a	b	c
	mm	mm	mm
57266-13	44	70	135

Thoraxsperrer, Rippenkontraktoren, Lungenspatel
 Thoracic retractor, Rib Contractors, Lung Spatulas
 Separador torácico, Aproximadores para costillas, Espátulas pulmonares
 Divaricatore per il torace, Approssimatori costali, Spatole per polmone



MERCEDES compl.
 57270-00

57270-80
 Sperrer allein
 Retractor only
 Separador solo
 Divaricatore solo

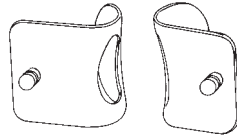

57270-65
 42x65 mm

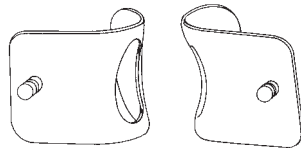

57270-75
 75x75 mm

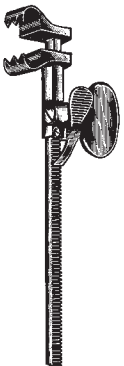

BAILEY-BABY
 57283-14
 14 cm, 5 1/2"



BAILEY
 57284-16
 16 cm, 6 1/4"



BAILEY-GIBBON
 57286-16
 16 cm, 6 1/4"



57288-30
 30 cm, 11 3/4"



ALLISON
 57289-32
 32 cm, 12 3/4"

Lungenfaßzange, Bronchusklemmen
 Lung Grasping Forceps, Bronchus Forceps
 Pinzas para coger el pulmón, Pinzas clamps bronquiales
 Pinze per afferrare il polmone, Pinze per bronchi



LOVELACE
 57290-20
 20 cm, 8"



LOVELACE
 57291-20
 20 cm, 8"



HARRINGTON
 57301-30
 30,5 cm, 12"

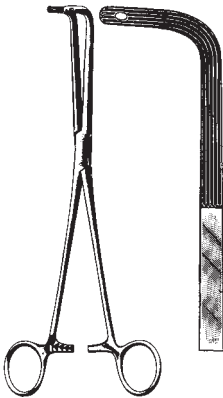

FINOCIETTO
 57307-24
 24 cm, 9 1/2"

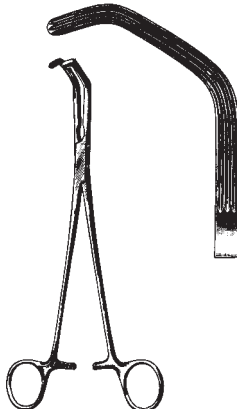

PRICE-THOMAS
 57309-22
 22 cm, 8 3/4"

Zähne links
 tooth left
 dientes izquierda
 denti sinistro
 57311-22



PRICE-THOMAS
 22 cm, 8 3/4"

rechts
 derecha
 destro
 57313-22

Bronchusklemmen, Gefäßklemmen
 Bronchus Forceps, Blood Vessel Clamps
 Pinzas clamps bronquiales, Pinzas-clamps para vasos
 Pinze per bronchi, Pinze cardiovascolari

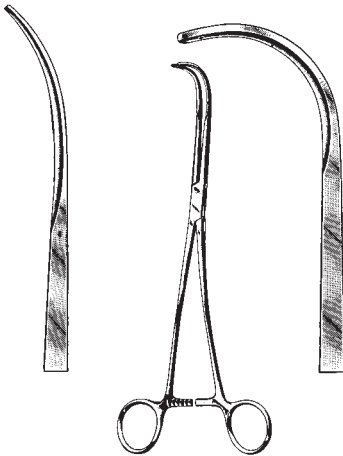

57321-23

SEMB
23 cm, 9"

57323-23

SATINSKY
57325-15
15 cm, 6"SATINSKY
57327-26 - 57329-26
26 cm, 10 1/4"

Fig. 1 57327-26

Fig. 2 57329-26

Coarctations-Klemmen
Coarctation clamps
Pinzas clamps para coartación
Pinza per coartazione

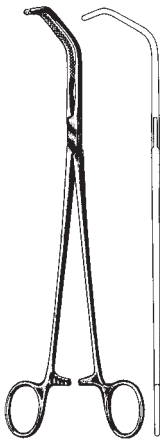
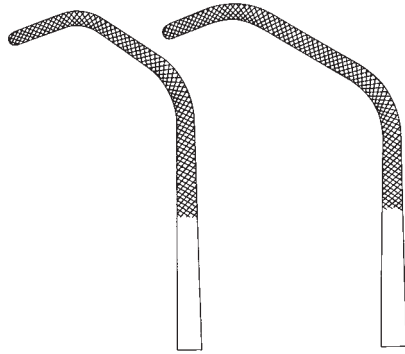
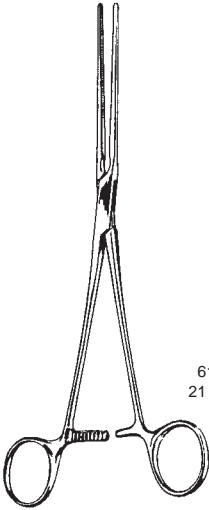

POTTS
61000-21 - 61000-22



61000-21
21 cm, 8 1/4"



61000-22
22 cm, 8 3/4"

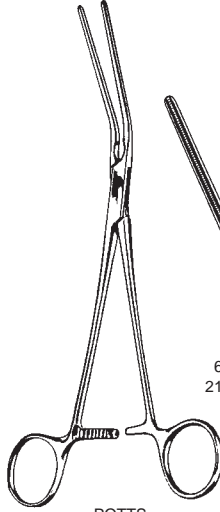

POTTS
61001-21 - 61001-22



61001-21
21 cm, 8 1/4"



61001-22
22 cm, 8 3/4"

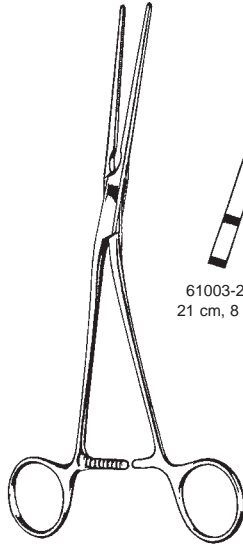

POTTS
61003-21 - 61003-22



61003-21
21 cm, 8 1/4"



61003-22
22 cm, 8 3/4"



Anastomosens-Klemmen, Präparier- und Ligaturklemmen
 Anastomosis clamps, Dissecting and ligature forceps
 Pinzas clamps para anastomosis, Pinzas para preparaciones y ligaduras
 Pinze per anastomosi, Pinze per preparazioni e legature

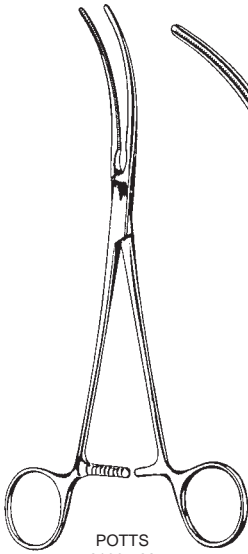

POTTS
 61005-22
 22 cm, 8 3/4"

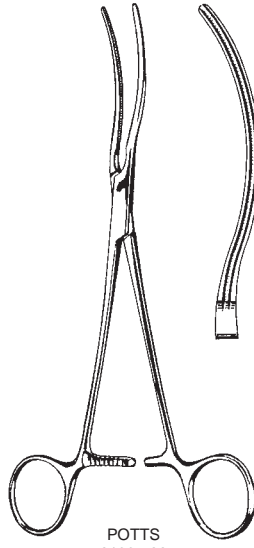

POTTS
 61007-22
 22 cm, 8 3/4"

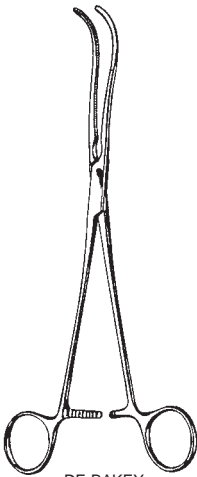

DE BAKEY
 61008-19 - 61008-23



61008-19
 19 cm, 7 1/2"



61008-23
 23 cm, 9"

Peripheral-Gefäßklemmen
 Peripheral vascular clamps
 Pinzas-clamps para vasos periféricos
 Pinze vascolari periferici

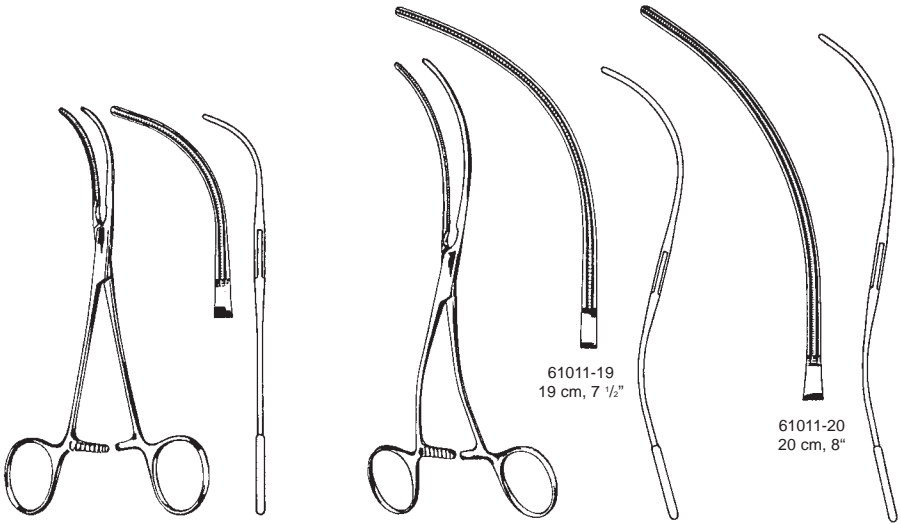

DE BAKEY
 61009-16
 16 cm, 6 1/4"

DE BAKEY
 61011-19 - 61011-20

61011-19
 19 cm, 7 1/2"

61011-20
 20 cm, 8"

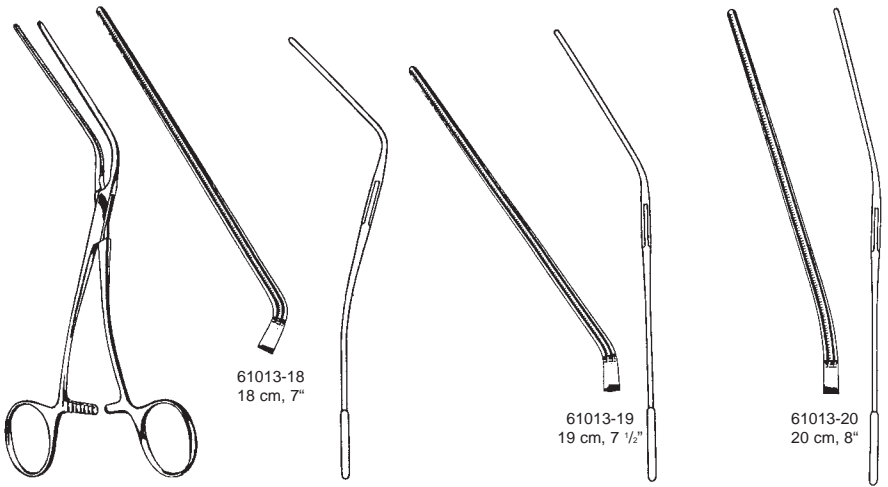

LELAND-JONES
 61013-18 - 61013-20

61013-18
 18 cm, 7"

61013-19
 19 cm, 7 1/2"

61013-20
 20 cm, 8"

Mehrzweck-Gefäßklemme
 Multi purpose Vascular Clamps
 Pinzas vasculares de usos multiples
 Pinze vascolari universali

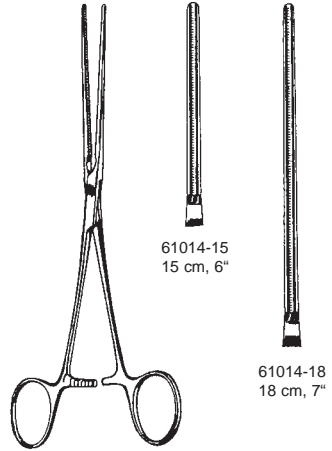

BAINBRIDGE
 61014-15 - 61014-18

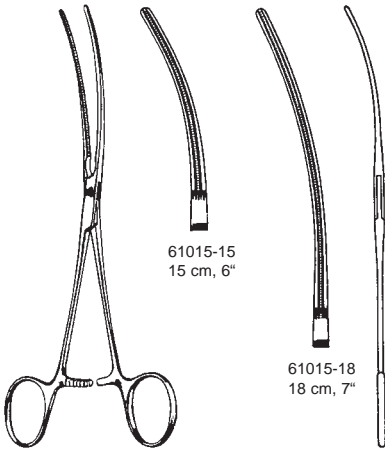

BAINBRIDGE
 61015-15 - 61015-18

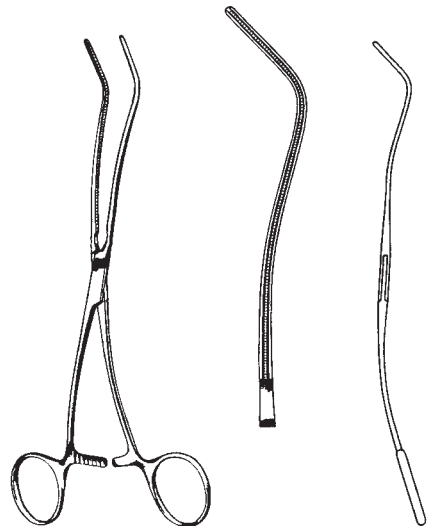

DE BAKEY
 61016-20
 20 cm, 8"

Aorta-Aneurysmaklemmen
Aortic aneurysm clamps
Pinzas-clamps para aneurisma de la aorta
Pinze per aneurisma aorta



61017-26
26 cm, 10 1/4"

61017-27
27 cm, 10 1/2"

61017-31
31 cm, 12 1/4"

61017-33
33 cm, 13"

DE BAKEY
61017-26 - 61017-33

Aorta-Aneurysmaklemmen
Aortic aneurysm clamps
Pinzas-clamps para aneurisma de la aorta
Pinze per aneurisma aorta



DE BAKKEY
61018-28
28 cm, 11"

Aorta-Aneurysmaklemmen
Aortic aneurysm clamps
Pinzas-clamps para aneurisma de la aorta
Pinze per aneurisma aorta

Draufsicht
Top view
Vista de arriba
Vista da vicino

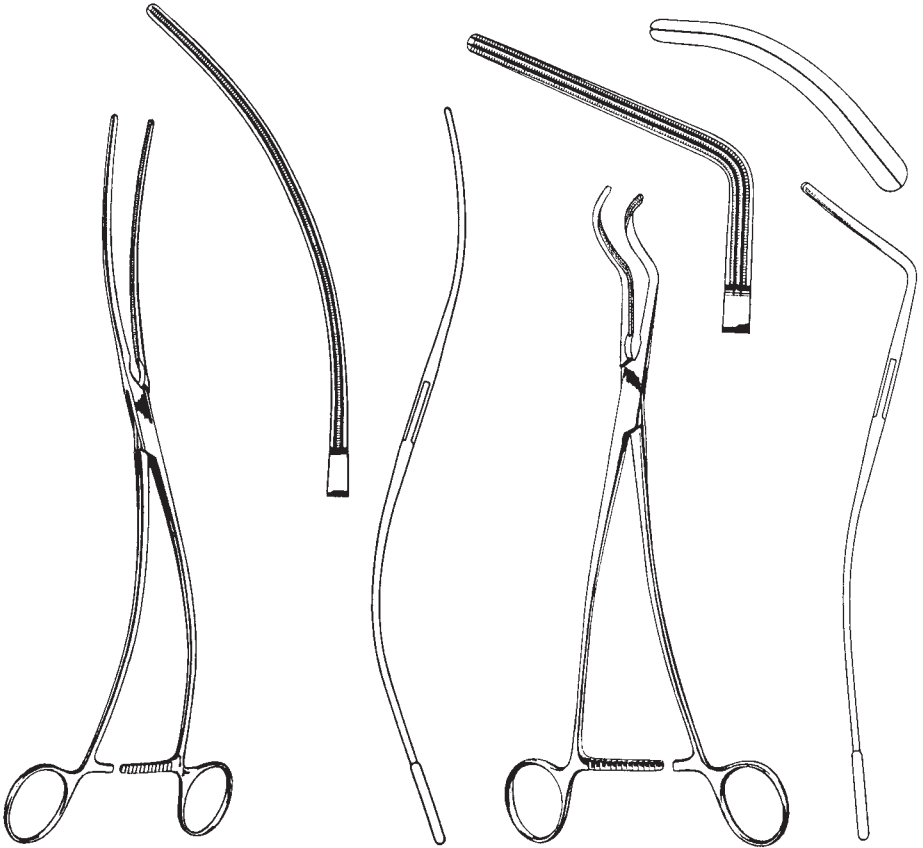

DE BAKEY
61019-30
30 cm, 11 3/4"

DE BAKEY
61020-27
27 cm, 10 1/2"

Ligaturklemmen, Aortaklemme
 Ligature clamps, Aortic clamp
 Pinzas clamps para ligaduras y la aorta
 Pinze per legature e aorta

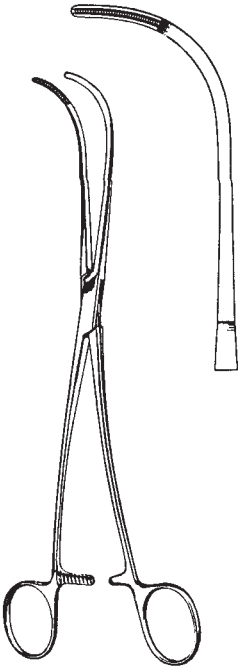

DE BAKEY-SEMB
 61021-24
 24 cm, 9 1/2"

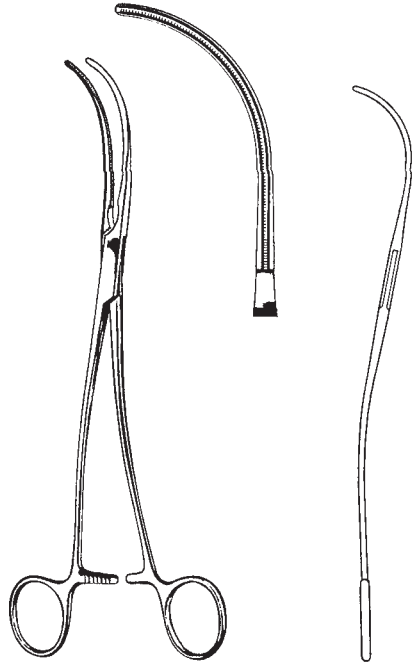

DE BAKEY
 61022-24
 24 cm, 9 1/2"

Ligaturklemme, Aortaklemme
Ligature clamp, Aortic clamp
Pinzas clamps para ligaduras y la aorta
Pinze per legature e aorta

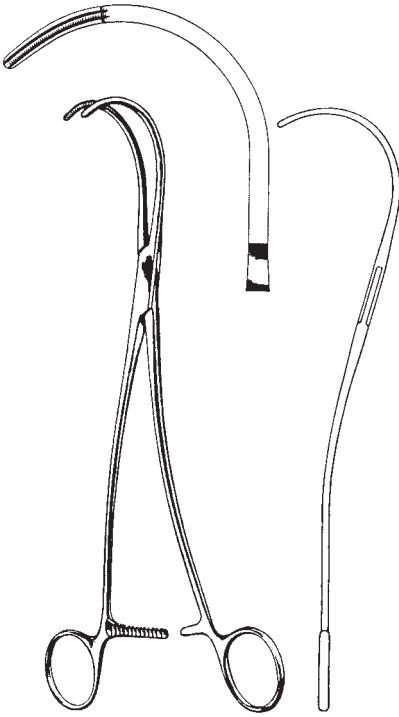

DE BAKEY
61023-25
25 cm, 10"

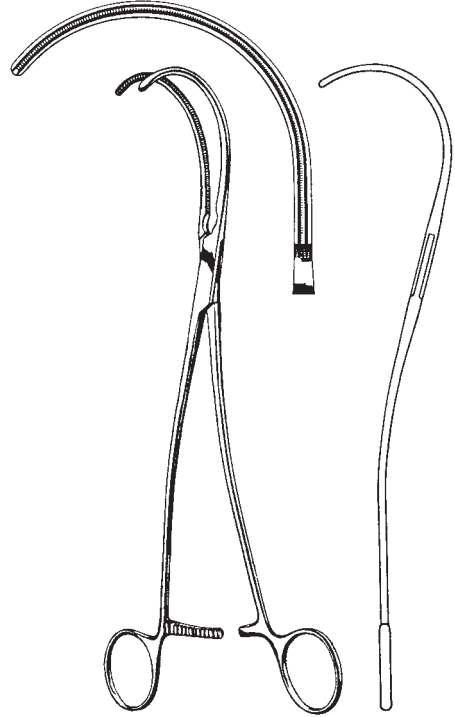

DE BAKEY
61023-26
26 cm, 10 1/4"

Aortaklemmen
Aortic clamps
Pinzas-clamps para la aorta
Pinze per aorta

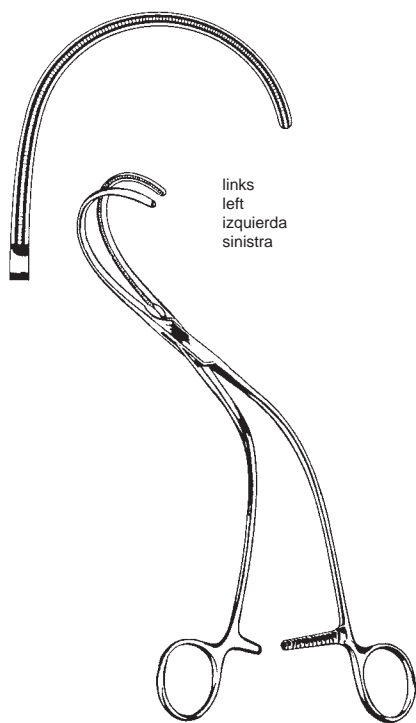

links
left
izquierda
sinistra

WEBER
61024-01
26 cm, 10 1/4"

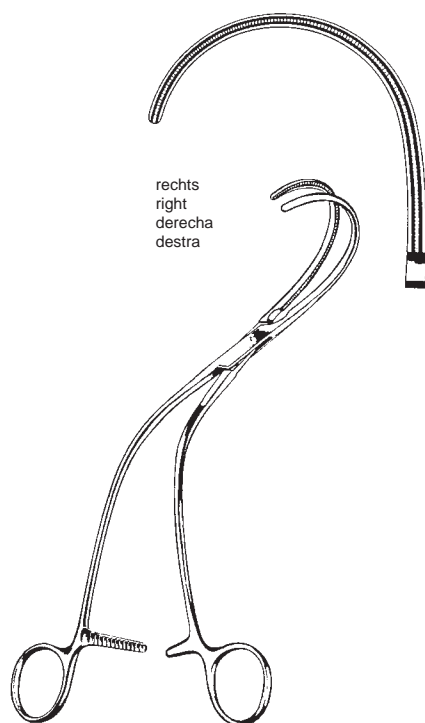

rechts
right
derecha
destra

WEBER
61024-02
26 cm, 10 1/4"

Tangentialklemmen
Tangential occlusion clamps
Pinzas-clamps para oclusión tangencial
Pinze per occlusione tangenziale

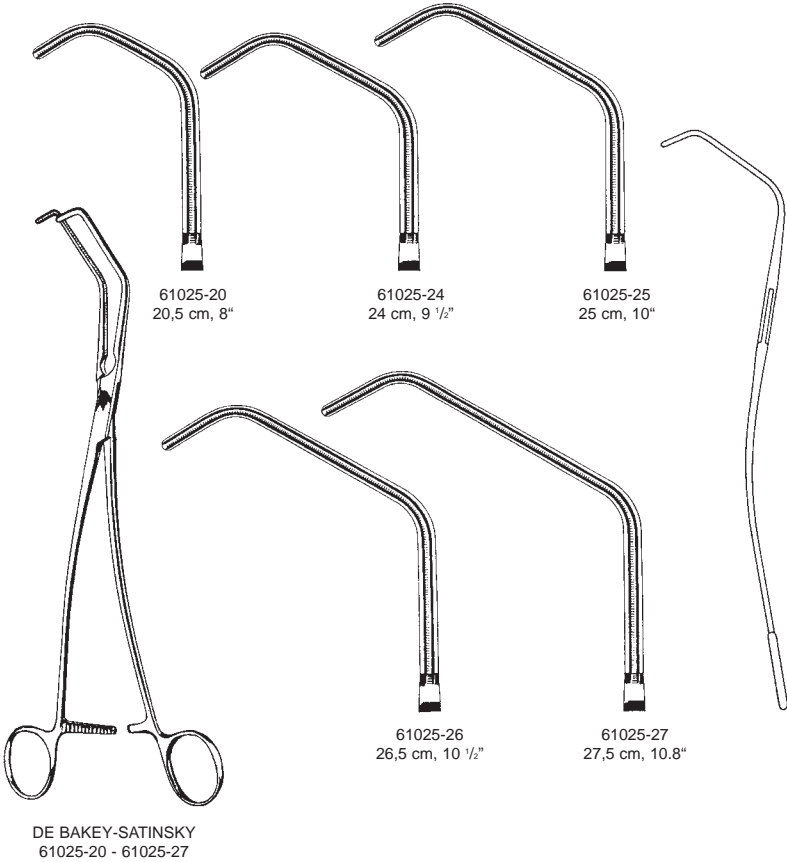

Aurikelklemmen
 Auricle clamps
 Pinza-clamps auriculares
 Pinza auricula



HARKEN
 61026-01 - 61026-04



61026-01
 24 cm, 9 1/2"

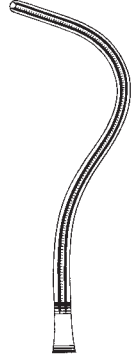

61026-02
 24 cm, 9 1/2"

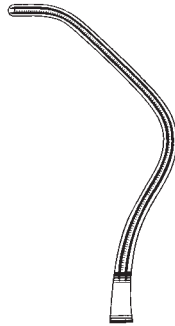

61026-03
 24 cm, 9 1/2"

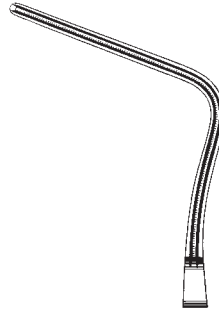

61026-04
 24 cm, 9 1/2"

Bronchusklemmen
Bronchus clamp
Pinzas-clamps bronquiales
Pinze per bronchi

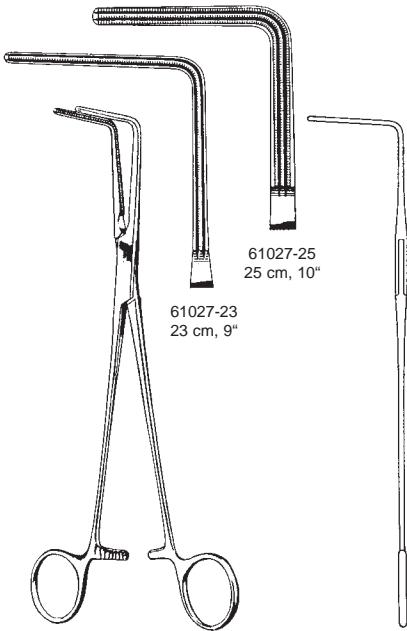

LEES
61027-23 - 61027-25

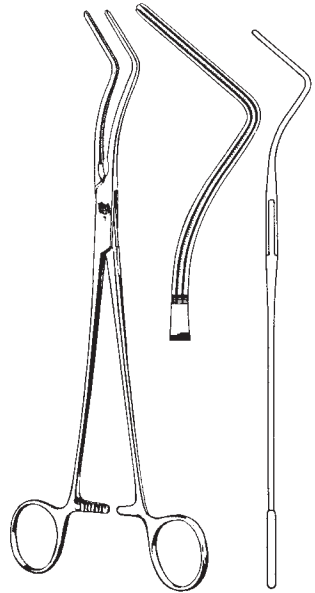

LEES
61029-25
25 cm, 10"

Aorta-Anastomosenklemmen
 Aortic anastomosis clamps
 Pinzas-clamps para anastomosis
 Pinze anastomosi aorta

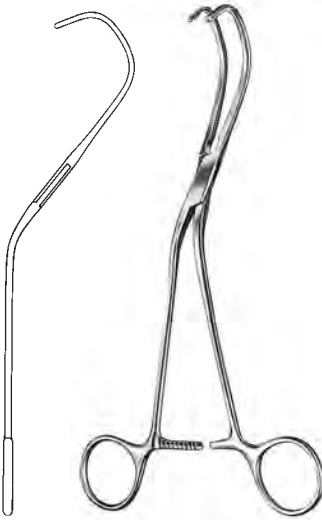

LAMBERT-KAY
 21 cm, 8 1/4"
 61030-21 - 61030-22

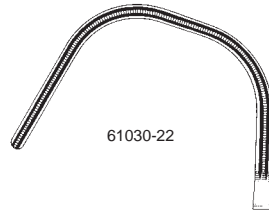

61030-22

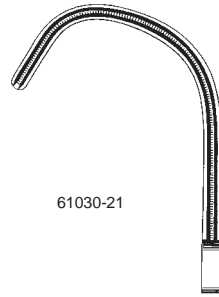

61030-21



DE BAKEY
 61031-17
 17 cm, 6 3/4"

Aorta - und Aneurysmaklemme
 Aortic- and Aneurysm clamps
 Pinzas aórticas y para aneurisma
 Pinze per aorta e per aneurisma

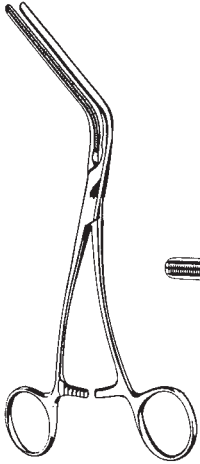

MORRIS-DE BAKEY
 61032-18 - 61032-25

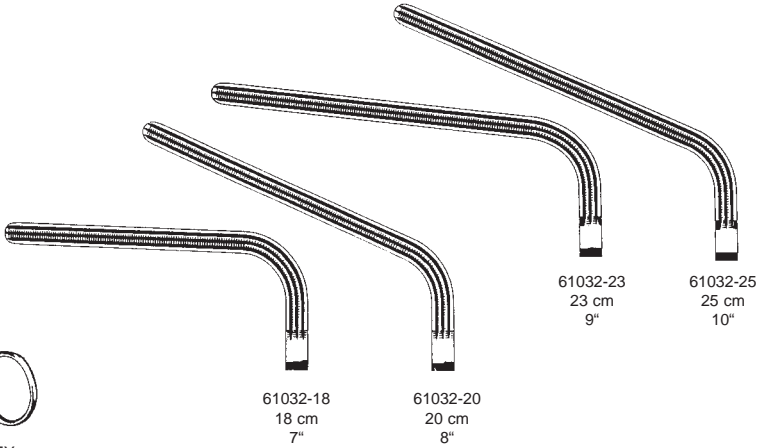

61032-18
 18 cm
 7"

61032-20
 20 cm
 8"

61032-23
 23 cm
 9"

61032-25
 25 cm
 10"

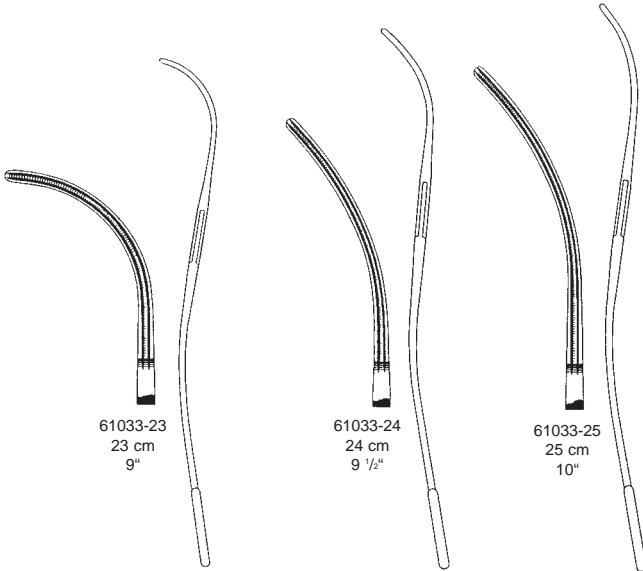

61033-23
 23 cm
 9"

61033-24
 24 cm
 9 1/2"

61033-25
 25 cm
 10"

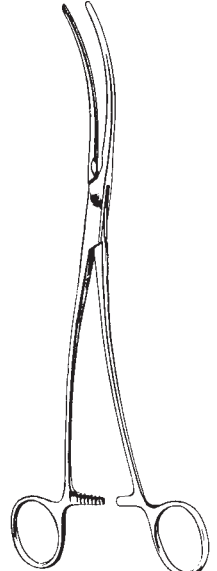

DE BAKEY-BAHNSON
 61033-23 - 61033-25

Coarctations-Klemmen
 Coarctation clamps
 Pinzas-clamps para coartación
 Pinze per coartazione

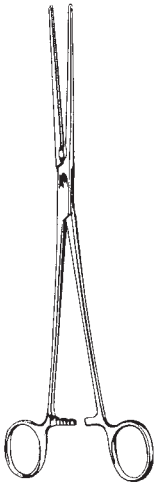

DE BAKEY
 61034-21 - 61034-31



61034-21
 21,5 cm
 8 1/2"



61034-23
 23 cm
 9"



61034-27
 27 cm
 10 1/2"



61034-31
 31,5 cm
 12 1/2"

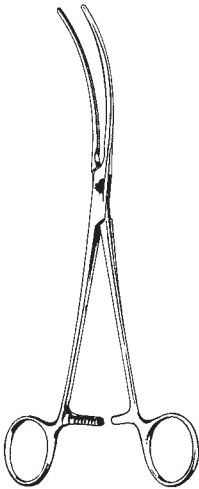

DE BAKEY
 61035-21 - 61035-31



61035-21
 21,5 cm
 8 1/2"



61035-23
 23 cm
 9"



61035-27
 27 cm
 10 1/2"



61035-31
 31 cm
 12 1/4"

Mehrweckklemmen
 Multi purpose clamps
 Pinzas-clamps para usos varios
 Pinze per usi multipli

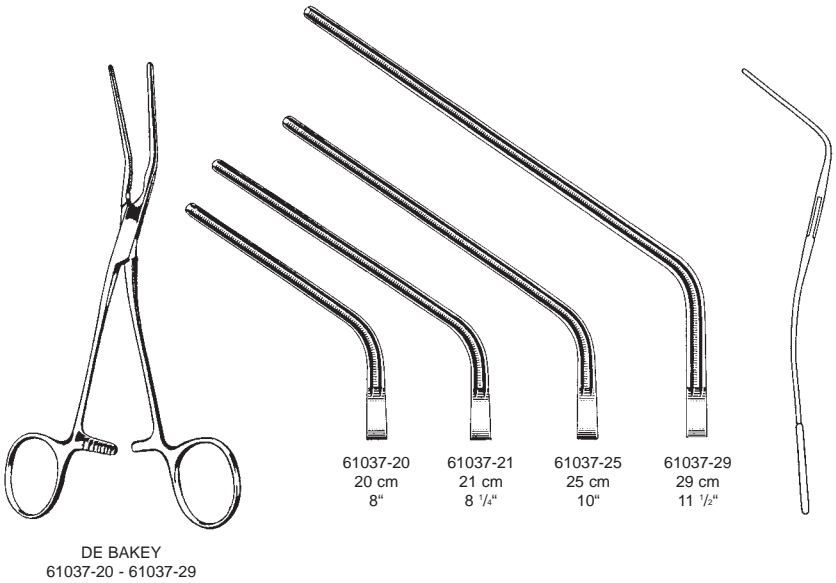
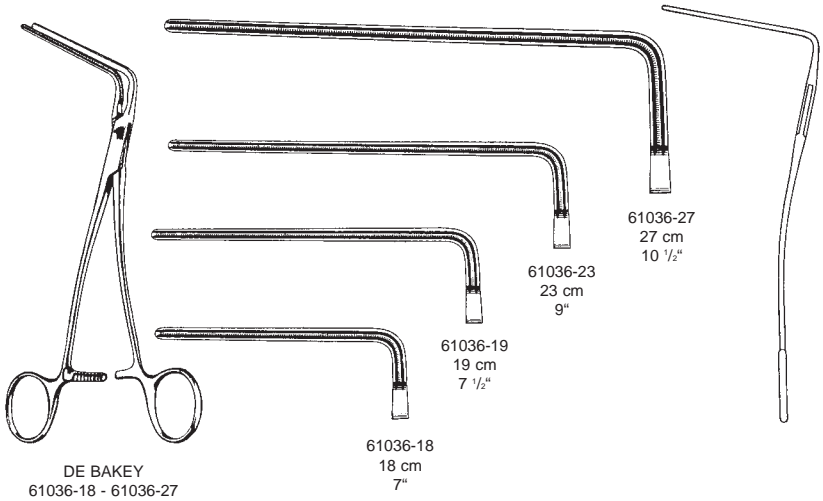

Atrauma-Arterienklemmen
Atrauma hemostatic forceps
Pinzas hemostáticas atraumáticas
Pinze emostatiche Atrauma

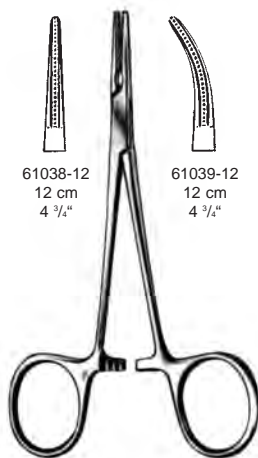

61038-12
12 cm
4 3/4"

61039-12
12 cm
4 3/4"

DE BAKEY-MOSQUITO
61038-12 - 61039-12

Aortaklemme, Katheterklemme
 Aortic clamps, Catheter clamps
 Pinzas-clamps para aorta, Pinzas para catéteres
 Pinze per aorta, Pinze per cateteri

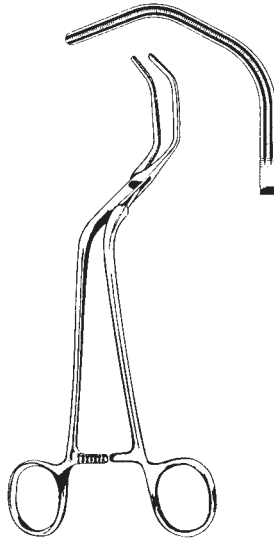

DIETRICH
 61040-21 21 cm, 8 1/2"

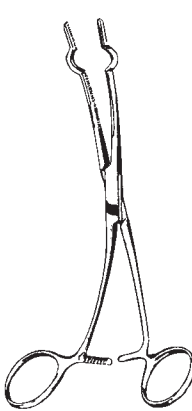

COOLEY
 61050-01 - 61050-07

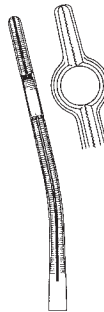

Charrière (French)	Länge Length Largo Lungo cm	
24	16	6 1/2" 61050-01
26	16	6 1/2" 61050-02
28	20	8" 61050-03
30	20	8" 61050-04
32	20	8" 61050-05
36	20	8" 61050-07

61050-01 - 61050-02
 für Kinder
 for children
 para niños
 per bambini

61050-03 - 61050-07
 für Erwachsene
 for adults
 para adultos
 per adulti

Carotis-Shuntklemmen
Carotid Shunt Clamps
Pinzas para shunt carótido
Pinze per carotide



JAVID
61045-18
17,5 cm, 6.9"



JAVID
61046-19
18 cm, 7"

Atrauma Cardiovascular-Klemmen
Atrauma Cardiovascular Forceps
Pinzas-clamps cardiovasculares
Pinze per chirurgia vascolare

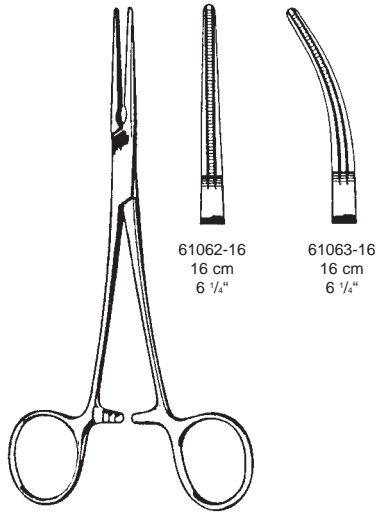

DE BAKEY-RANKIN
61062-16 - 61063-16

Atrauma Cardiovascular-Klemmen
 Atrauma Cardiovascular Forceps
 Pinzas-clamps cardiovasculares
 Pinze per chirurgia vascolare

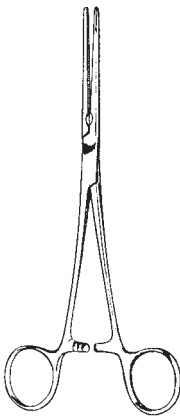

DE BAKEY-PEAN
 61138-14 - 61138-20



61138-14
 14 cm
 5 1/2"



61138-16
 16 cm
 6 1/4"



61138-18
 18 cm
 7"



61138-20
 20 cm
 8"

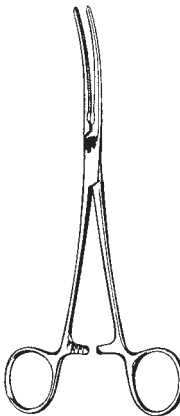

DE BAKEY-PEAN
 61139-14 - 61139-20



61139-14
 14 cm
 5 1/2"



61139-16
 16 cm
 6 1/4"



61139-18
 18 cm
 7"



61139-20
 20 cm
 8"

Atrauma Cardiovascular-Klemmen
Atrauma Cardiovascular Forceps
Pinzas-clamps cardiovasculares
Pinze per chirurgia vascolare

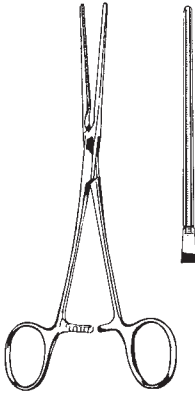

DE BAKEY
61140-17
17 cm, 6 3/4"

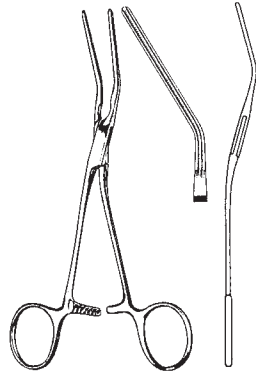

DE BAKEY
61141-16
16 cm, 6 1/4"

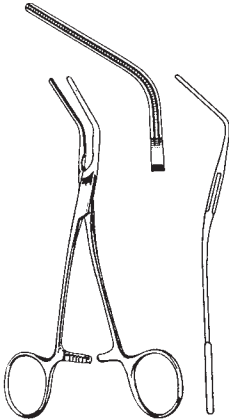

DE BAKEY
61143-15
15 cm, 6"

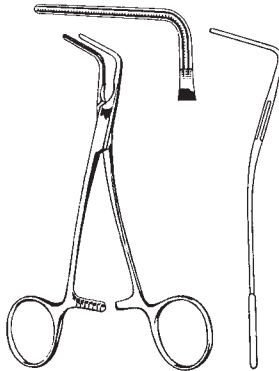

DE BAKEY
61145-15
15 cm, 6"

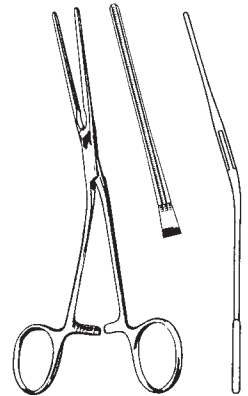

DE BAKEY
61147-17
17 cm, 6 3/4"

Atrauma Cardiovascular-Klemmen
 Atrauma Cardiovascular Forceps
 Pinzas-clamps cardiovasculares atraumáticas
 Pinze cardiovascolari atraumatiche

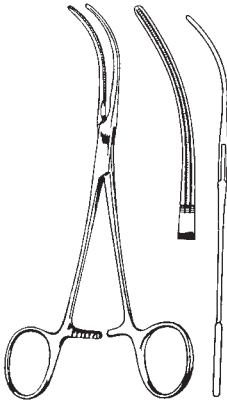

GLOVER
 61149-17
 17 cm, 6 3/4"

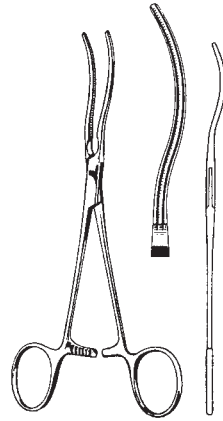

DE BAKEY
 61151-17
 17 cm, 6 3/4"

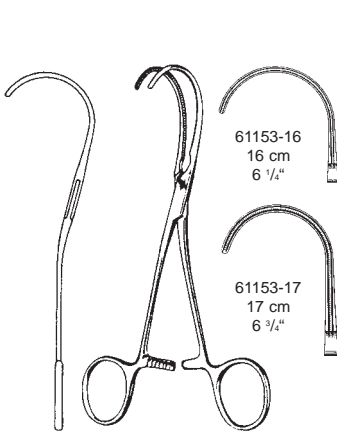

DE BAKEY
 61153-16 - 61153-17

61153-16
 16 cm
 6 1/4"

61153-17
 17 cm
 6 3/4"

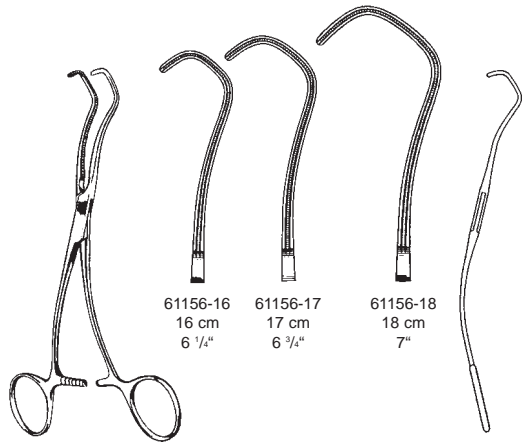

DERRA
 61156-16 - 61156-18

61156-16
 16 cm
 6 1/4"

61156-17
 17 cm
 6 3/4"

61156-18
 18 cm
 7"

Atrauma Cardiovascular-Klemmen
 Atrauma Cardiovascular Forceps
 Pinzas-clamps cardiovasculares atraumáticas
 Pinze atraumatiche per chirurgia vascolare

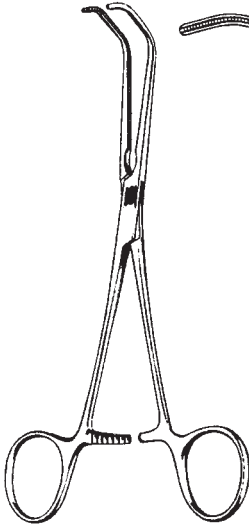

BECK
 61157-17 17 cm, 6 3/4"

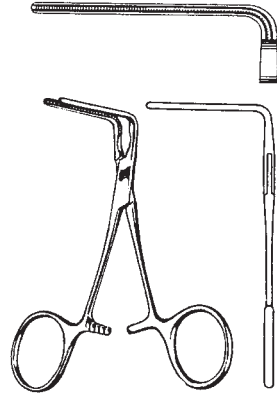

DE BAKEY
 61158-10 10 cm, 4"

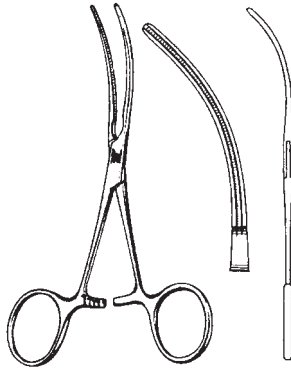

DE BAKEY
 61158-11 11 cm, 4 1/8"

Atrauma Cardiovascular-Klemmen
 Atrauma Cardiovascular Forceps
 Pinzas-clamps cardiovasculares atraumáticas
 Pinze atraumatiche per chirurgia vascolare

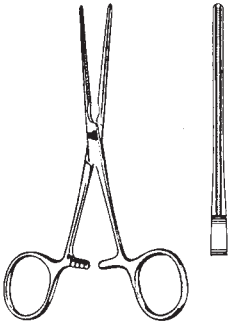

DE BAKEY
 61158-12 12 cm, 4 3/4"

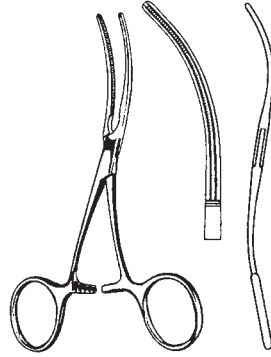

DE BAKEY
 61159-12 11,5 cm, 4 1/2"

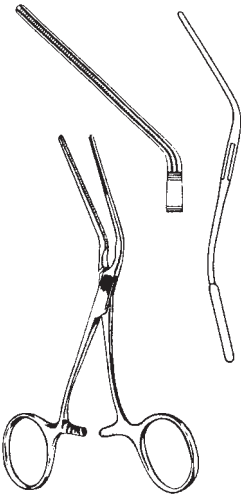

DE BAKEY
 61159-13 13 cm, 5 1/8"

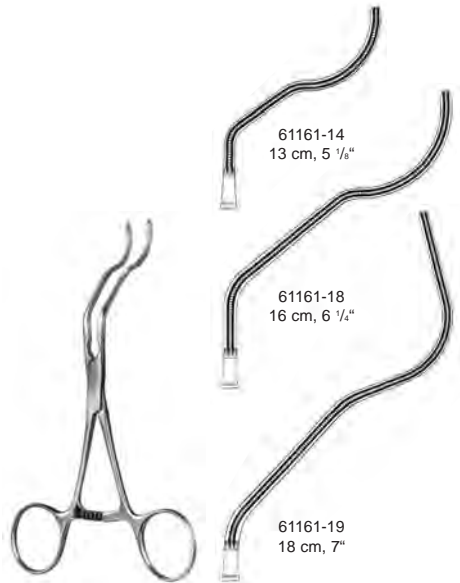

GREGORY

61161-14
 13 cm, 5 1/8"

61161-18
 16 cm, 6 1/4"

61161-19
 18 cm, 7"

Atrauma Cardiovascular-Klemmen
 Atrauma Cardiovascular Forceps
 Pinzas-clamps cardiovasculares atraumáticas
 Pinze atraumatiche per chirurgia vascolare

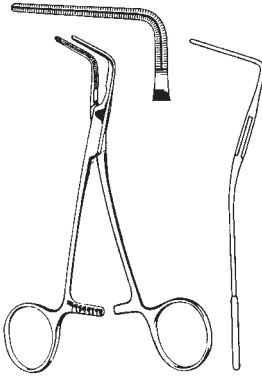

COOLEY
 61172-15
 15 cm, 6"

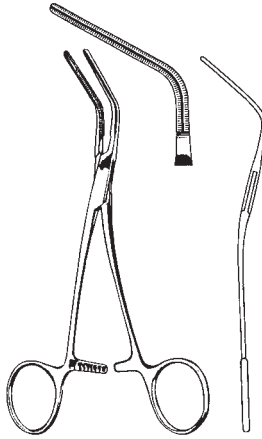

COOLEY
 61173-16
 15,5 cm, 6"

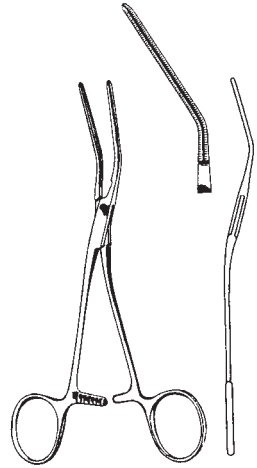

COOLEY
 61174-17
 17 cm, 6 3/4"

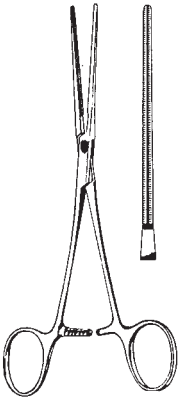

COOLEY
 61175-17
 17 cm, 6 3/4"

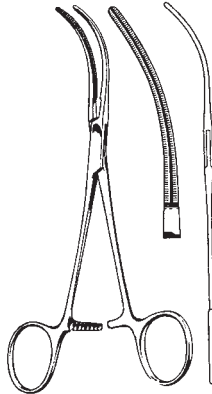

COOLEY
 61176-17
 17 cm, 6 3/4"

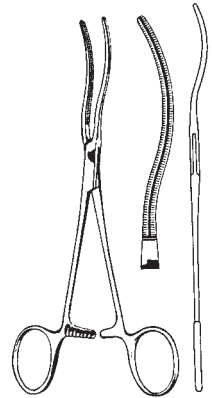

COOLEY
 61177-17
 17 cm, 6 3/4"

Atrauma Cardiovascular-Klemmen
 Atrauma Cardiovascular Forceps
 Pinzas-clamps cardiovasculares atraumáticas
 Pinze atraumatiche per chirurgia vascolare

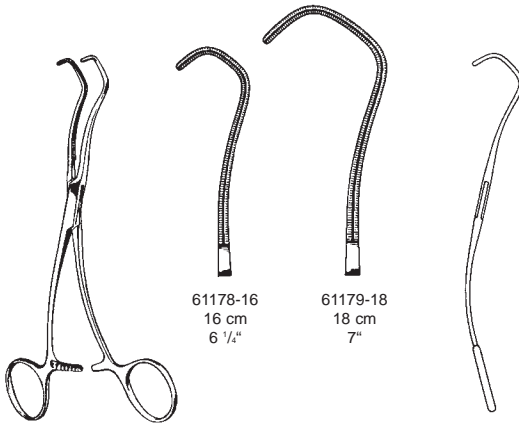

61178-16
 16 cm
 6 1/4"

61179-18
 18 cm
 7"

COOLEY-DERRA
 61178-16 - 61179-18

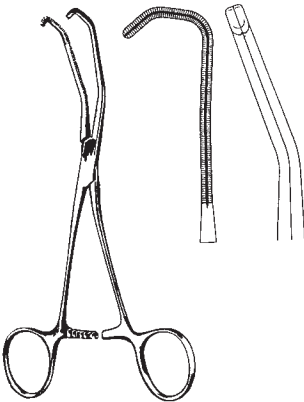

COOLEY
 61180-17
 17 cm, 6 3/4"

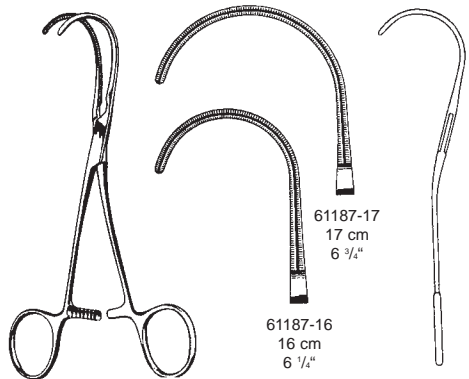

61187-17
 17 cm
 6 3/4"

61187-16
 16 cm
 6 1/4"

COOLEY
 61187-16 - 61187-17

Anastomosenklemmen, Mehrzweck-Gefäßklemme
 Anastomosis clamp, Multi purpose Vascular Clamps
 Pinza clamp para iliac y anastomosis, Pinzas vasculares de usos multiples
 Pinze anastomosi, Pinze vascolari universali

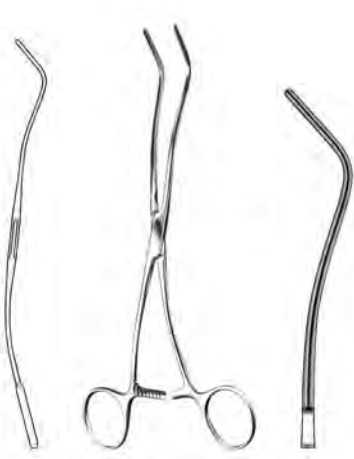

COOLEY
 61188-20 20 cm, 8"

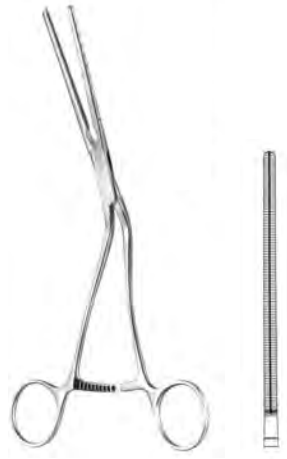

COOLEY
 61189-21 21 cm, 8 1/4"



BECK
 61190-17
 17 cm, 6 3/4"

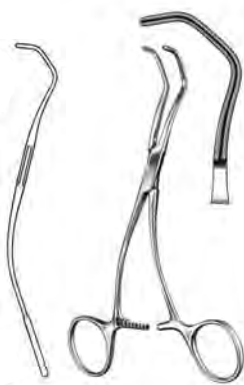

COOLEY
 61191-16
 16 cm, 6 1/4"



COOLEY
 61192-17
 17 cm, 6 3/4"

Kinder-Aortaklemme
 Pediatric Aortic Clamps
 Pinza aórticas pediátricas
 Pinze per aorta pediátriche

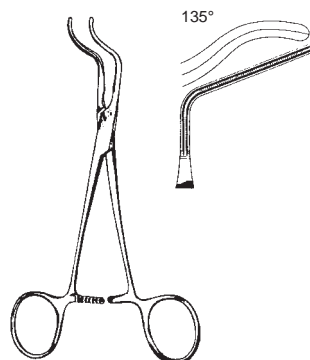

SUBRAMANIAN-MINIATURE
 61259-15 15,5 cm, 6"

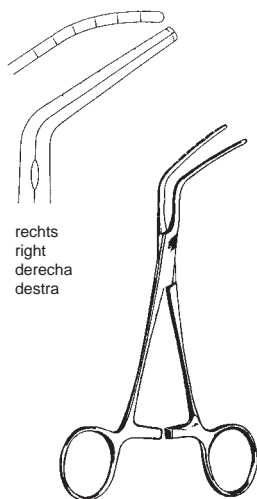

rechts
 right
 derecha
 destra

SUBRAMANIAN
 61261-16 16 cm, 6 1/4"

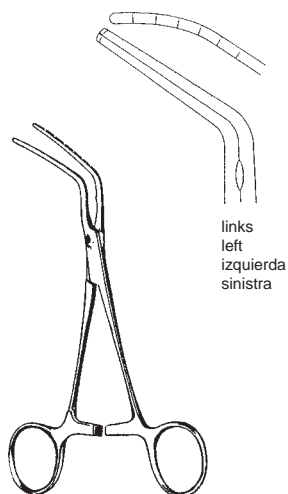

links
 left
 izquierda
 sinistra

SUBRAMANIAN
 61263-16 16 cm, 6 1/4"

Atrauma Neonatal- und Kinderklemmen, extra feine Modelle
Atrauma and Pediatric clamps, delicate Patterns
Pinzas-clamps para recién nacidos y pediátricos, modelos muy delicados, atraumáticos
Pinze Atrauma per neonati e bambini, modelli estremamente fini

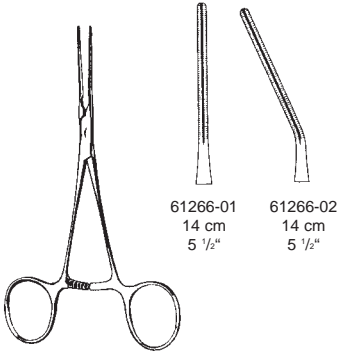

COOLEY
61266-01 - 61266-02
14 cm, 5 1/2"

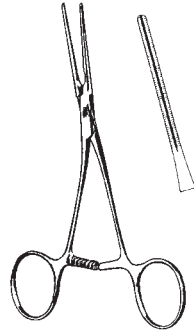

COOLEY
61266-03 14 cm, 5 1/2"

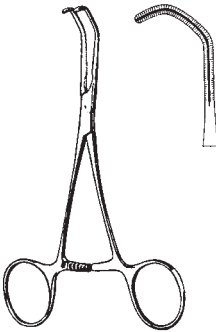

COOLEY
61266-04 14 cm, 5 1/2"

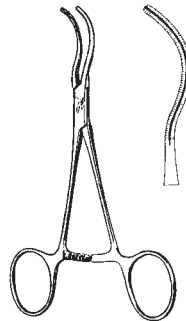

COOLEY
61266-05 14 cm, 5 1/2"

Atrauma Neonatal- und Kinderklemmen
 Neonatal and Pediatric Clamps
 Pinzas-clamps pediátricas y para recién-nacidos, atraumáticas
 Pinze per neonati e bambini

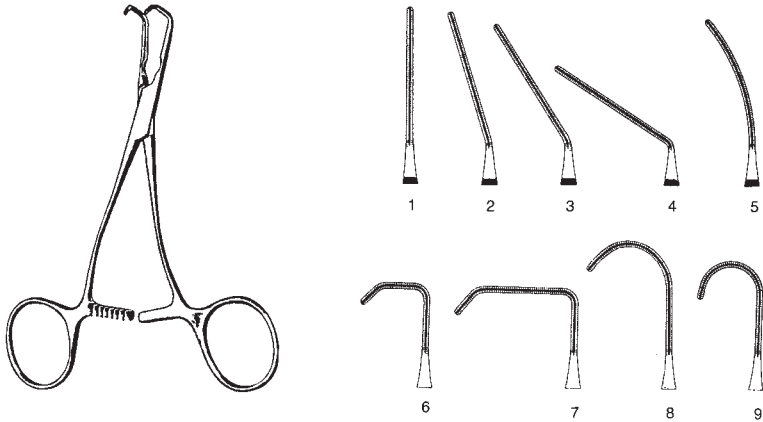

gerade
 straight
 rectas
 rette

Fig.

1	61372-01 14 cm, 5 1/2"
2	61372-02 14 cm, 5 1/2"
3	61372-03 14 cm, 5 1/2"
4	61372-04 13 cm, 5 1/8"
5	61372-05 14 cm, 5 1/2"
6	61372-06 13 cm, 5 1/8"
7	61372-07 13 cm, 5 1/8"
8	61372-08 14 cm, 5 1/2"
9	61372-09 13,5 cm, 5 1/4"

stark abgewinkelt
 strongly angled
 ramas anguladas
 forte angolata

Fig.

1	61373-01 14 cm, 5 1/2"
2	61373-02 14 cm, 5 1/2"
3	61373-03 14 cm, 5 1/2"
4	61373-04 13 cm, 5 1/8"
5	61373-05 14 cm, 5 1/2"
6	61373-06 13 cm, 5 1/8"
7	61373-07 13 cm, 5 1/8"
8	61373-08 14 cm, 5 1/2"
9	61373-09 13,5 cm, 5 1/4"

abgewinkelt
 angled
 acodadas
 angolate

Fig.

1	61374-01 14 cm, 5 1/2"
2	61374-02 14 cm, 5 1/2"
3	61374-03 14 cm, 5 1/2"
4	61374-04 13 cm, 5 1/8"
5	61374-05 14 cm, 5 1/2"
6	61374-06 13 cm, 5 1/8"
7	61374-07 13 cm, 5 1/8"
8	61374-08 14 cm, 5 1/2"
9	61374-09 13,5 cm, 5 1/4"

Clipanlagezangen für die offene Chirurgie 25° aufgebogen
 Clip Appliers for open Surgery 25° upcurved
 Pinza applicadora de clips para cirugía abierta con ángulo de 25°
 Pinza applicatore clips per chirurgia aperto, curvo in alto 25°



15 cm, 6"

Horizon

61460-15 Small gelb / yellow / jaune/ amarillo/ giallo
 61461-15 Medium blau / blue / bleu / azul / blu

SLS Clips

61464-15 Micro weiss / white / blanc / blanco / bianco
 61465-15 Small gelb / yellow / jaune/ amarillo/ giallo
 61466-15 Small medium lila / lilac / lilas / lila / lilla
 61467-15 Medium blau / blue / bleu / azul / blu

Ethicon

61470-15 Small blau / blue / bleu / azul / blu
 61471-15 Medium weiss / white / blanc / blanco / bianco

Pilling

61481-15 Small gelb / yellow / jaune / amarillo / giallo
 61482-15 Medium blau / blue / bleu / azul / blu

Horizon

61460-19 Small gelb / yellow / jaune / amarillo / giallo
 61461-19 Medium blau / blue / bleu / azul / blu
 61462-19 Medium Large grün / green / verde / verde
 61463-19 Large orange / naranja / arancione

SLS Clips

61464-19 Micro weiss / white / blanc / blanco / bianco
 61465-19 Small gelb / yellow/ jaune / amarillo / giallo
 61466-19 Small medium lila / lilac / lilas / lila / lilla
 61467-19 Medium blau / blue / bleu / azul / blu
 61468-19 Medium Large grün / green / verde / verde
 61469-19 Large orange / naranja / arancione

Ethicon

61470-19 Small blau / blue / bleu / azul / blu
 61471-19 Medium weiss / white / blanc / blanco / bianco
 61472-19 Medium Large grün / green / verde / verde
 61473-19 Large gelb / yellow / jaune / amarillo / giallo

Pilling

61481-19 Small gelb / yellow / jaune / amarillo / giallo
 61482-19 Medium blau / blue / bleu / azul / blu
 61484-19 Medium Large grün / green / verde / verde
 61483-19 Large orange / naranja / arancione



19 cm, 7 1/2"

Clipanlagezangen für die offene Chirurgie 25° aufgebogen
 Clip Appliers for open Surgery 25° upcurved
 Pinza aplicadora de clips para cirugía abierta con ángulo de 25°
 Pinza applicatore clips per chirurgia aperto, curvo in alto 25°



28 cm, 11"

Horizon

61461-28 Medium blau / blue / bleu / azul / blu
 61462-28 Medium Large grün / green / verde / verde
 61463-28 Large orange / naranja / arancione

SLS Clips

61464-28 Micro weiss / white / blanco / bianco
 61465-28 Small gelb / yellow / jaune / amarillo / giallo
 61466-28 Small medium lila / lilac / lilas / lila / lilla
 61467-28 Medium blau / blue / bleu / azul / blu
 61468-28 Medium Large grün / green / verde / verde
 61469-28 Large orange / naranja / arancione

Ethicon

61471-28 Medium weiss / white / blanco / bianco
 61472-28 Medium Large grün / green / verde / verde
 61473-28 Large gelb / yellow / jaune / amarillo / giallo

Pilling

61482-28 Medium blau / blue / bleu / azul / blu
 61484-28 Medium Large grün / green / verde / verde
 61483-28 Large orange / naranja / arancione

Atrauma Cardiovascular-Klemmen, extra feine Modelle
Atrauma Cardiovascular Forceps, extra delicate Patterns
Pinzas-clamps cardiovasculares, modelos muy delicados, atraumáticos
Pinze atraumatiche per chirurgia vascolare, modelli delicati

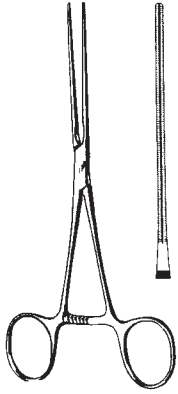

61488-16
16,5 cm, 6 1/2"

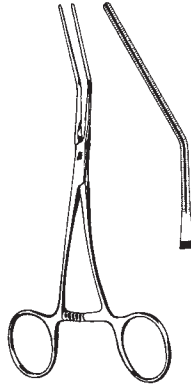

61489-16
16 cm, 6 1/4"

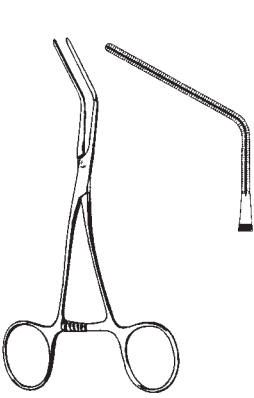

61490-15
15 cm, 6"



61491-15
15 cm, 6"

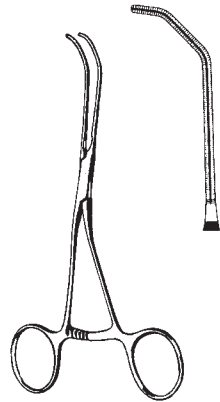

61492-16
15,5 cm, 6"

Neonatal-Klemmen
 Neonatal-Clamps
 Pinzas-clamps para recién-nacidos
 Pinze per neonati

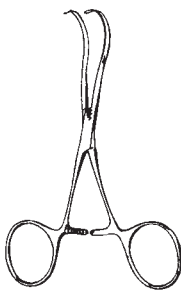
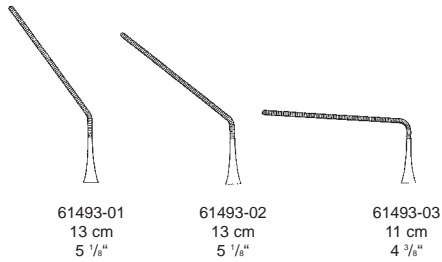

CASTANEDA
 61493-01 - 61495-04

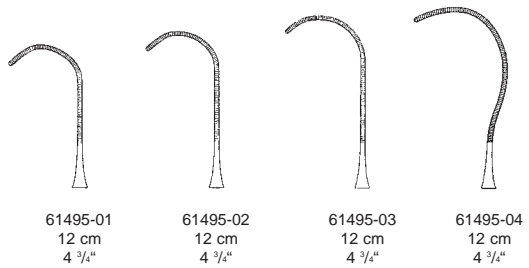

Aorta Dilatoren, Tourniquets
 Aortic Dilators, Tourniquets
 Diladores de aorta, Tourniquets
 Dilatori vascolari, Tornichetti

Spreizweite von 8 - 42 mm
 Blade opening from 8 to 42 mm
 Abertura de 8 a 42 mm
 Apertura da 8 a 42 mm

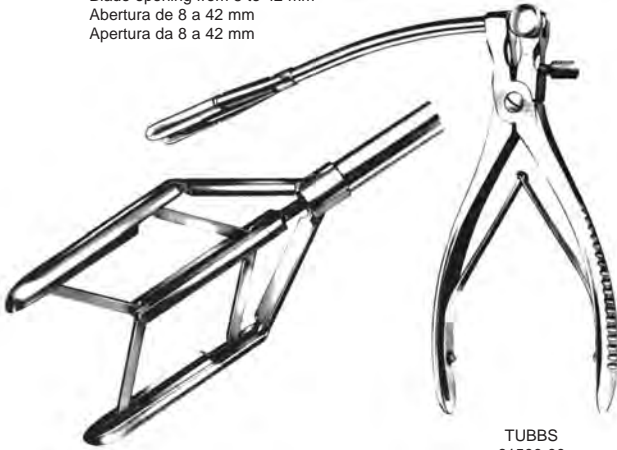

TUBBS
 61500-00

Spreizweite von 8 - 15 mm
 Blade opening from 8 to 15 mm
 Abertura de 8 a 15 mm
 Apertura da 8 a 15 mm



COOLEY
 61506-00



RUMEL-BELMONT
 61700-33 3,2 mm Ø
 61710-33 6,4 mm Ø
 33 cm, 13"
 flexibel, flexible,
 flexible, flessibile

61700-01
 61710-01
 Mandrin alleine
 Guide only
 Guida sola

Gefäß-Dilatatoren
 Vascular Dilators
 Dilatadores vasculares
 Dilatatori vascolari

biegsam
 malleable
 malleables
 malleabili

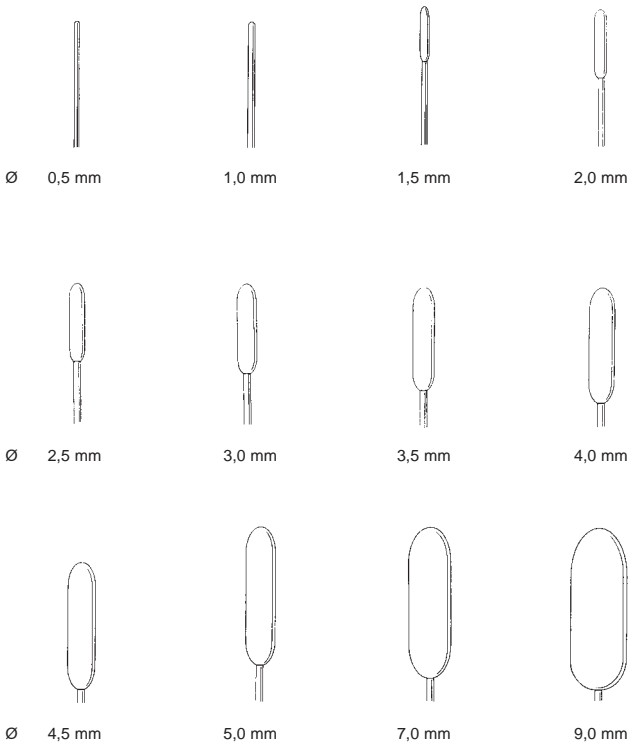

DE BAKEY

19 cm, 7 1/2"	Ø mm	35 cm, 13 3/4"
61810-05	0,5	61820-05
61810-10	1,0	61820-10
61810-15	1,5	61820-15
61810-20	2,0	61820-20
61810-25	2,5	61820-25
61810-30	3,0	61820-30
61810-35	3,5	61820-35
61810-40	4,0	61820-40
61810-45	4,5	61820-45
61810-50	5,0	61820-50
61810-70	7,0	61820-70
61810-90	9,0	61820-90

Spatel, Gefäßdissektoren
 Spatula, vascular Dissectors
 Espátulas, Disecadores vasculares
 Spatola, Dissettori vascolari

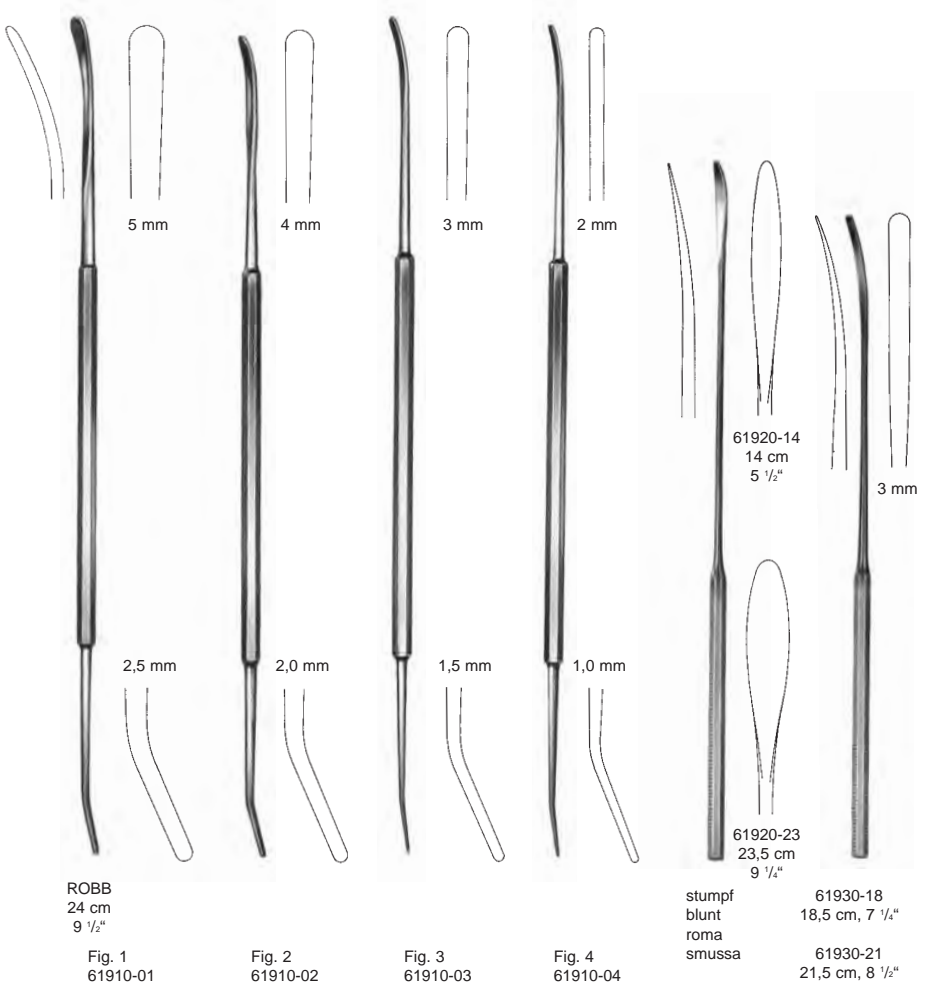

Gallensteinzangen
Gall Stone Forceps
Pinzas para cálculos biliares
Pinze per calcoli biliari



DESJARDINS
23 cm, 9"

Fig. 1
63101-23



Fig. 2
63103-23

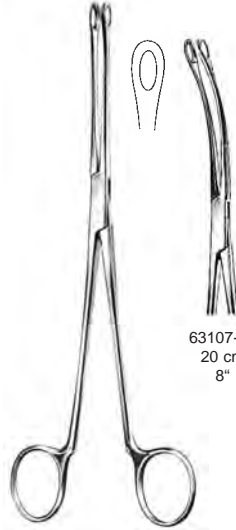

BLAKE
63106-20 20 cm, 8"

63107-20
20 cm
8"



MAYO-BLAKE
63110-20 20 cm, 8"



MAYO-BLAKE
63111-20 20 cm, 8"



MIXTER
63117-22 22 cm, 8 3/4"

Gallensteinsonden, Gallengangdilatoren
 Gall Stone Probes, Bile duct dilators
 Exploradores para cálculos biliares, Dilatadores para conductos biliares
 Sonde per calcoli biliari, Dilatatori per condotti biliari

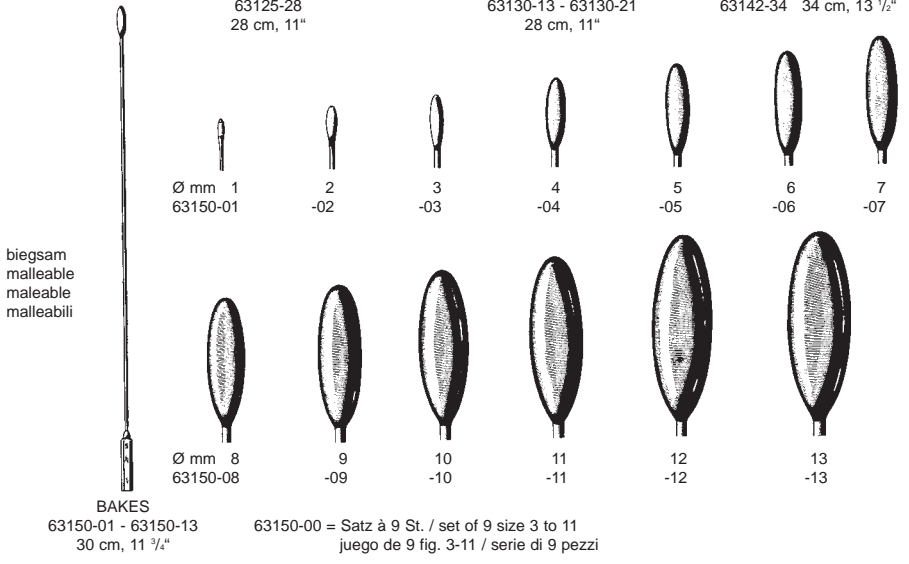
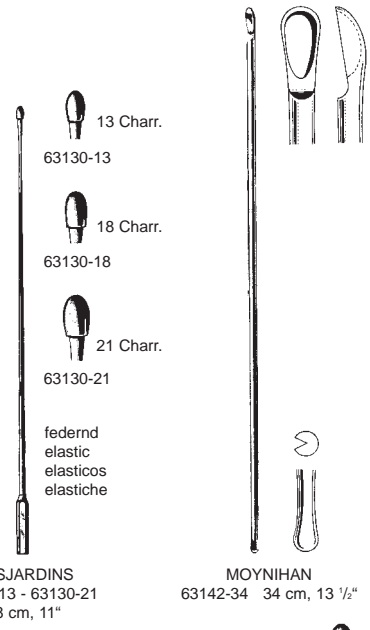
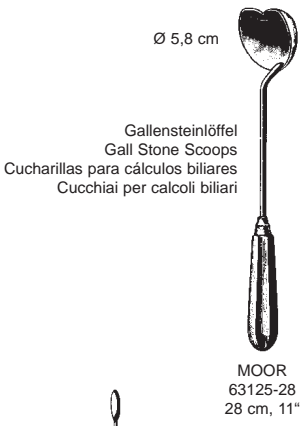

Gallensteinlöffel
 Gall Stone Scoops
 Cucharillas para cálculos biliares
 Cucchiari per calcoli biliari

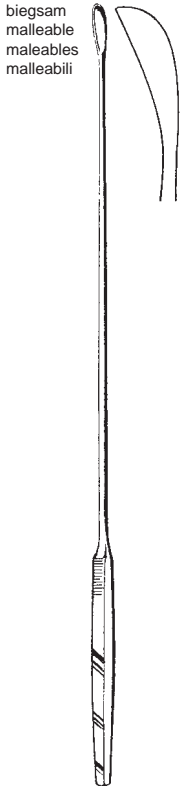

biegsam
 malleable
 maleables
 malleabili

LUER-KOERTE
 63173-01 - 63173-08
 32 cm, 12 3/4"



FERGUSSON
 63170-21 - 63170-23

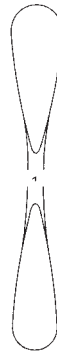

63170-21
 21,5 cm
 8 1/2"

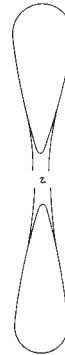

63170-22
 22 cm
 8 3/4"

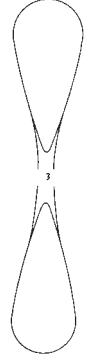

63170-23
 23,5 cm
 9 1/4"

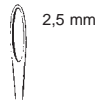

Fig. 000
 63173-01

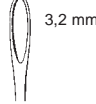

Fig. 00
 63173-02

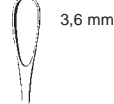

Fig. 0
 63173-03

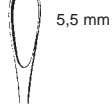

Fig. 1
 63173-04

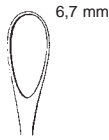

Fig. 2
 63173-05

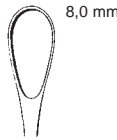

Fig. 3
 63173-06

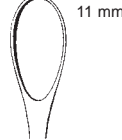

Fig. 4
 63173-07

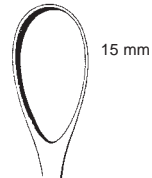

Fig. 5
 63173-08

Gallensteiniöffel
 Gall Stone Scoops
 Cucharillas para cálculos biliares
 Cucchiari per calcoli biliari



MAYO
 63175-27
 27 cm, 10 1/2"



63178-01
 klein, small, pequeña, piccola

63178-03
 groß, large, grande

MAYO
 63178-01 - 63178-03
 27 cm, 10 1/2"



DESJARDINS
 63180-17 - 63180-27
 30 cm, 11 3/4"



17 Charr.

Fig. 1
 63180-17



21 Charr.

Fig. 2
 63180-21



24 Charr.

Fig. 3
 63180-24



27 Charr.

Fig. 4
 63180-27

federn
 elastic
 elásticas
 elastiche



MAYO
 63210-32
 32 cm, 12 3/4"

Nierensteinzange, Nierenfistelzange
 Kidney Stone Forceps, Nephrostomy Forceps
 Pinzas para cálculos renales, Pinza para nefrostomía
 Pinze per calcoli renali, Pinze per nefrostomia



RANDALL

- Fig. 1 63231-01 23 cm, 9"
 Fig. 2 63231-02 22 cm, 8 3/4"
 Fig. 3 63231-03 22 cm, 8 3/4"
 Fig. 4 63231-04 22 cm, 8 3/4"
 Fig. 5 63231-05 19 cm, 7 1/2"
 Fig. 6 63231-06 19 cm, 7 1/2"

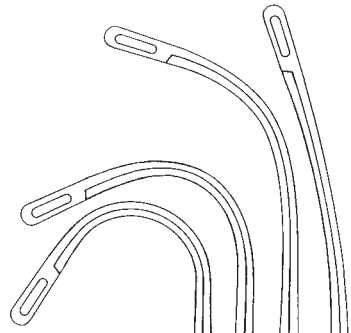

Fig. 4 Fig. 3 Fig. 2 Fig. 1

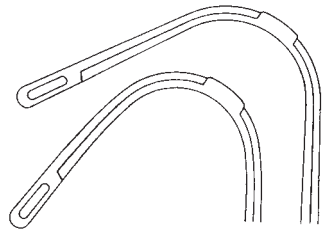

Fig. 6 Fig. 5

Nierensteinzange
Kidney Stone Forceps
Pinzas para cálculos renales
Pinze per calcoli renali



HEIMING

für Kinder
for children
para niños
per bambini



63232-01
17 cm, 6 3/4"



63232-02
16 cm, 6 1/4"

Darm-Organfaßzangen
 Bowel and Tissue Grasping Forceps
 Pinzas para coger intestinos y tejidos
 Pinze per afferrare intestini e tessuti



ALLIS-BABY
 65102-12 12 cm, 4 3/4"
 65102-14 14 cm, 5 1/2"

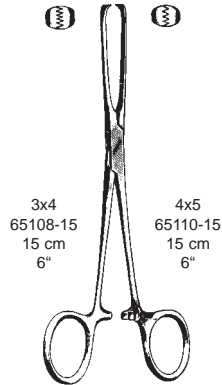

3x4 4x5
 65108-15 65110-15
 15 cm 15 cm
 6" 6"

ALLIS 5x6
 15 cm 6" 65120-15
 19 cm 7 1/2" 65120-19
 22 cm 8 3/4" 65120-22
 24 cm 9 1/2" 65120-24

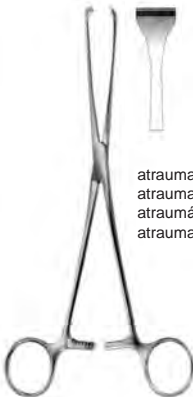

atrauma
 atraumatic
 atraumática
 atraumatica

ALLIS
 65124-16 16 cm, 6 1/4"
 65124-20 20 cm, 8"
 65124-22 22 cm, 8 3/4"
 65124-25 25 cm, 10"
 65124-30 30 cm, 11 3/4"

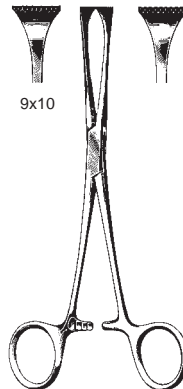

ALLIS-ADAIR
 65130-15
 15,5 cm, 6"

Darm-Organfaßzangen
 Bowel and Tissue Grasping Forceps
 Pinzas para coger intestinos y tejidos
 Pinze per afferrare intestini e tessuti

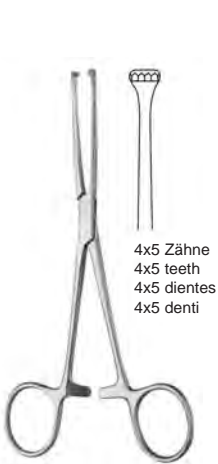

4x5 Zähne
 4x5 teeth
 4x5 dientes
 4x5 denti

LOCKWOOD-ALLIS
 65132-16 16 cm, 6 1/4"
 65132-20 20 cm, 8"

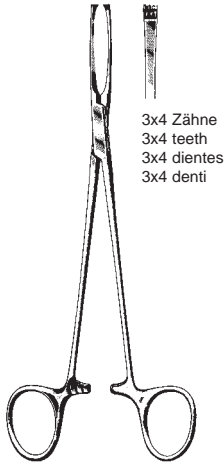

3x4 Zähne
 3x4 teeth
 3x4 dientes
 3x4 denti

JUDD-ALLIS
 65140-15 15 cm, 6"
 65140-19 19 cm, 7 1/2"

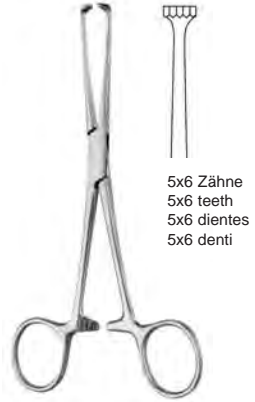

5x6 Zähne
 5x6 teeth
 5x6 dientes
 5x6 denti

BOYS-ALLIS
 65145-15 15 cm, 6"

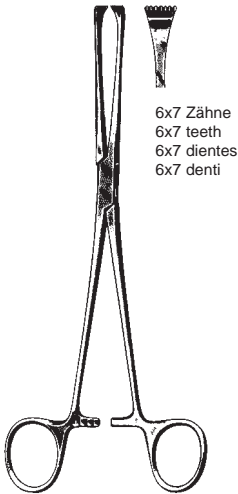

6x7 Zähne
 6x7 teeth
 6x7 dientes
 6x7 denti

THOMS-ALLIS
 65150-20 20 cm, 8"



2x3 Zähne
 2x3 teeth
 2x3 dientes
 2x3 denti

LITTLEWOOD
 65154-18 18,5 cm, 7 1/4"

Darmfaßzangen
 Intestinal Forceps
 Pinzas para coger tejidos e intestinos
 Pinze per afferrare tessuti ed organi

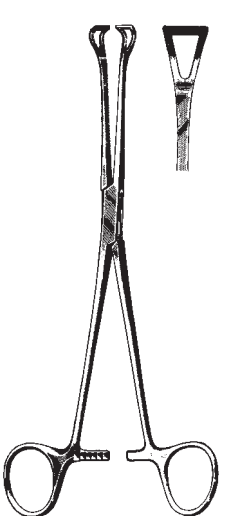

10 mm

atrauma
 atraumatic
 atraumática
 atraumatica

65168-16	16 cm, 6 1/4"
65168-20	20 cm, 8"

BABCOCK

65160-14	14 cm, 5 1/2"
65160-16	16 cm, 6 1/4" 65164-16 TC 16 cm
65160-18	18 cm, 7"
65160-20	20 cm, 8" 65164-20 TC 20 cm
65160-24	24 cm, 9 1/2"

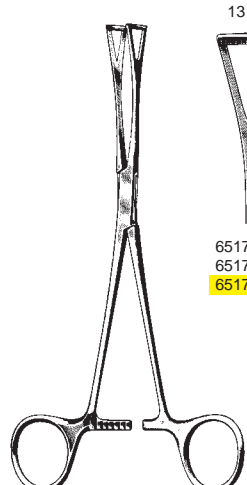

13 mm

25 mm

65170-18	18	7"
65170-20	20	8"
65174-20 TC	20	8"
65172-20	20	8"
65172-23	23	9"

DUVAL
 65170-18 - 65172-23



21 mm

23 mm

65178-19	19 cm 7 1/2"
65178-23	23 cm 9"

COLLIN



WILLIAMS
 65180-16 16,5 cm, 6 1/2"

Darmklemmen
 Intestinal Forceps
 Pinzas intestinales
 Pinze intestinali

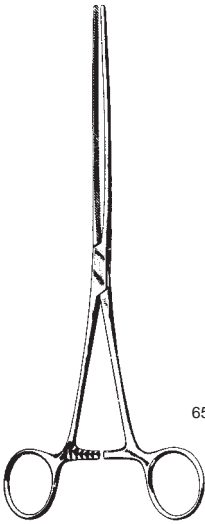

DOYEN
 65210-18 - 65217-23

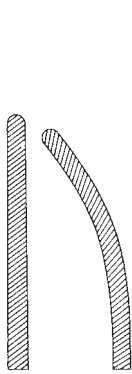

DOYEN-BABY
 65210-18 18 cm, 7"
 65211-18

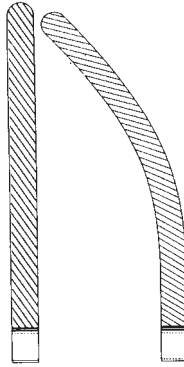

DOYEN
 65210-21 21 cm, 8 1/4"
 65210-23 23 cm, 9"
 65211-21
 65211-23

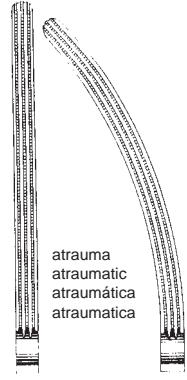

atrauma
 atraumatic
 atraumática
 atraumatica

DOYEN
 65216-13 13 cm, 5 1/4"
 65216-16 16 cm, 6 1/4"
 65216-18 18 cm, 7"
 65216-21 21 cm, 8 1/4"
 65216-23 23 cm, 9"
 65217-13
 65217-16
 65217-18
 65217-21
 65217-23

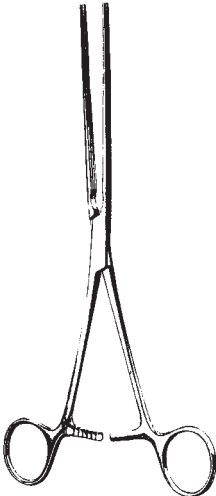

KOCHER
 65220-22 - 65227-28

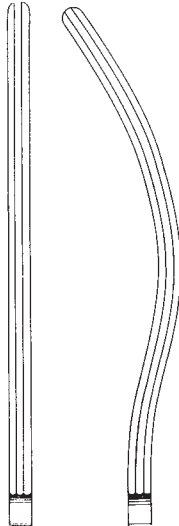

65220-13 13 cm, 5 1/4"
 65220-22 22 cm, 8 3/4"
 65220-25 25 cm, 10"
 65220-28 28 cm, 11"
 65221-13
 65221-22
 65221-25
 65221-28

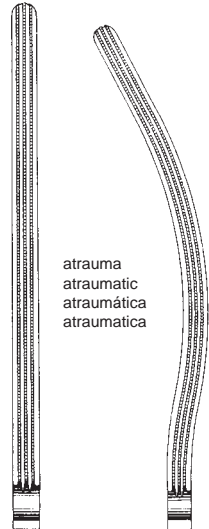

atrauma
 atraumatic
 atraumática
 atraumatica

BABY-KOCHER
 65226-22 22 cm, 8 3/4"
 65226-25 25 cm, 10"
 65226-28 28 cm, 11"
 65227-22
 65227-25
 65227-28

Darmklemmen
Intestinal Forceps
Pinzas intestinales
Pinze intestinali

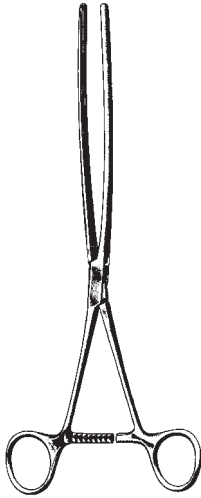

MAYO-ROBSON
65230-21 - 65237-25
21 - 25 cm
8 1/4" - 10"

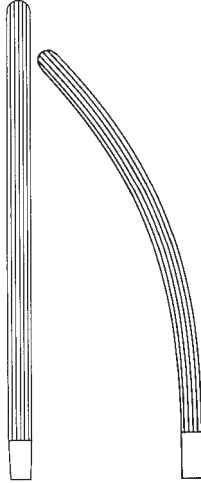

65230-21
65230-23
65230-25

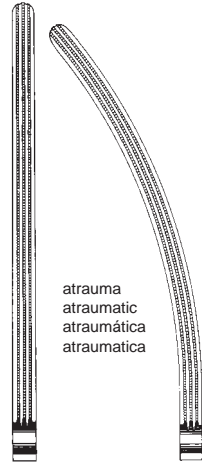

65236-25

65237-25

atrauma
atraumatic
atraumática
atraumatica



SCUDDER
65238-33
33 cm
13"

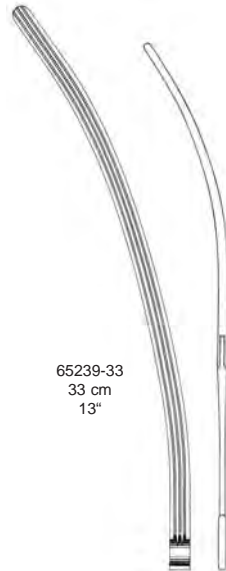

65239-33
33 cm
13"

Darmklemmen
Intestinal Forceps
Pinzas intestinales
Pinze intestinali



FEHLAND
65241-23
23,5 cm 9 1/4"



RESANO
65242-30
30 cm, 11 3/4"

Magen-Darmklemmen
Intestinal and Stomach Clamps
Pinzas-clamps intestinales y estomacales
Pinze intestinali e stomacali

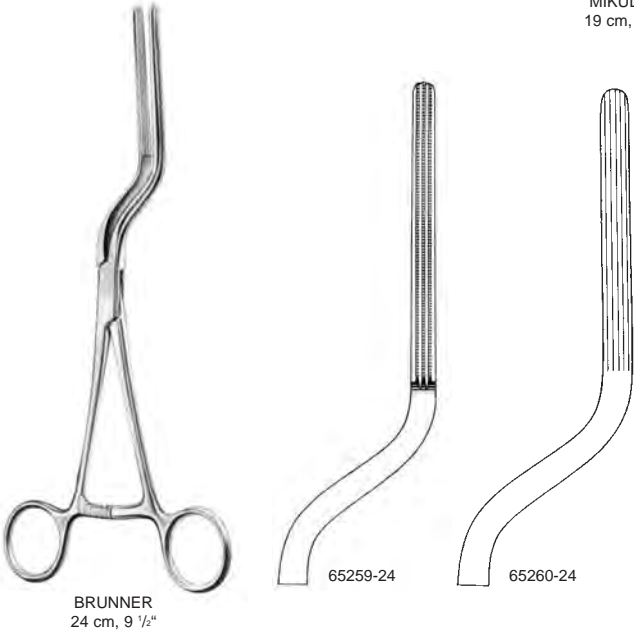
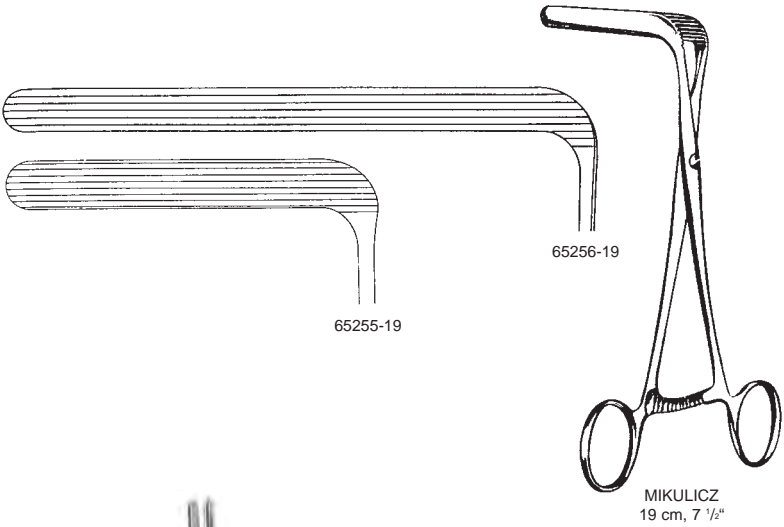

Pylorusspreizer, Blinddarmklemmen
 Pylorus spreader, Blindgut forceps
 Separador para piloro, Pinzas para apéndice
 Divaricatori per piloro, Pinza per appendice



BENSON
 65261-15
 15,5 cm, 6"

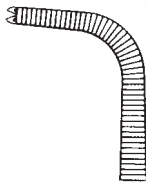

KLEINSCHMIDT
 65262-12
 12 cm, 4 3/4"

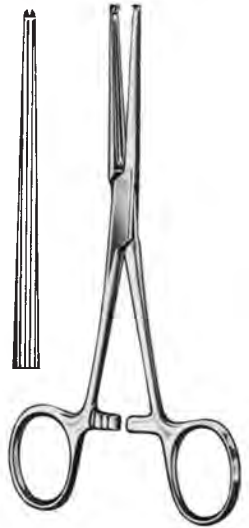

ALLEN
 65263-15 15 cm, 6"
 65263-20 20 cm, 8"

Atrauma Rektum-Anastomosenklemmen, Anostomosenklemmen
 Atrauma Sigmoid Anastomosis Forceps, Anastomosis Clamp Forceps
 Pinzas para anastomosis del recto atraumáticas, Pinzas clamps para anastomosis
 Pinze atrauma per anastomosi del retto, Pinze per anastomosi



HAYES
 65265-26 26 cm, 10 1/4"
 65265-28 28 cm, 11"

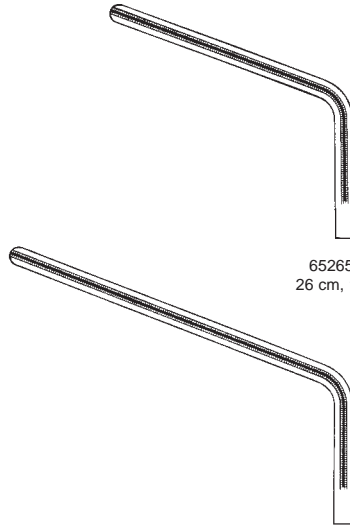

65265-26
 26 cm, 10 1/4"

65265-28
 28 cm, 11"

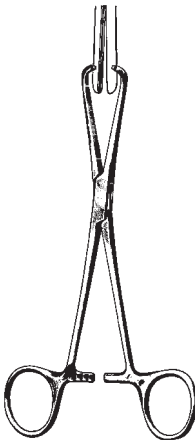

STONE
 65270-15
 15,5 cm, 6"



STONE-WATT
 65272-07 7,5 cm, 3"
 65272-10 10,0 cm, 4"



STONE-WATT
 65274-00

Anastomosenklemmen, Klemmschließzange, Klemmenhalter
 Anastomosis Clamp Forceps, Clamp closing forceps, Clamp Holder
 Pinzas-clamps para anastomosis, Pinzas para cerrar clamps, Porta-clamps
 Pinze per anastomosi, Serrapinze, Portapinze

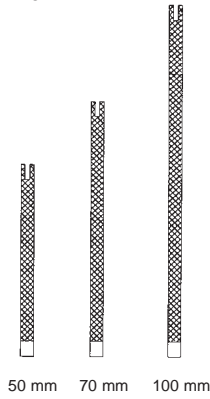

DE MARTEL-WOLFSON
 65280-05 5 cm, 2" set of 3
 65280-07 7 cm, 2 3/4" set of 3
 65280-10 10 cm, 4" set of 3



DE MARTEL-WOLFSON
 65282-26 26 cm, 10 1/4"



DE MARTEL-WOLFSON
 65284-08 8,5 cm, 3 1/2"



DE MARTEL-WOLFSON
 65284-23 23 cm, 9"

Magenquetschklemme
 Stomach Clamps
 Pinzas-clamps estomacales
 Pinze stomacali

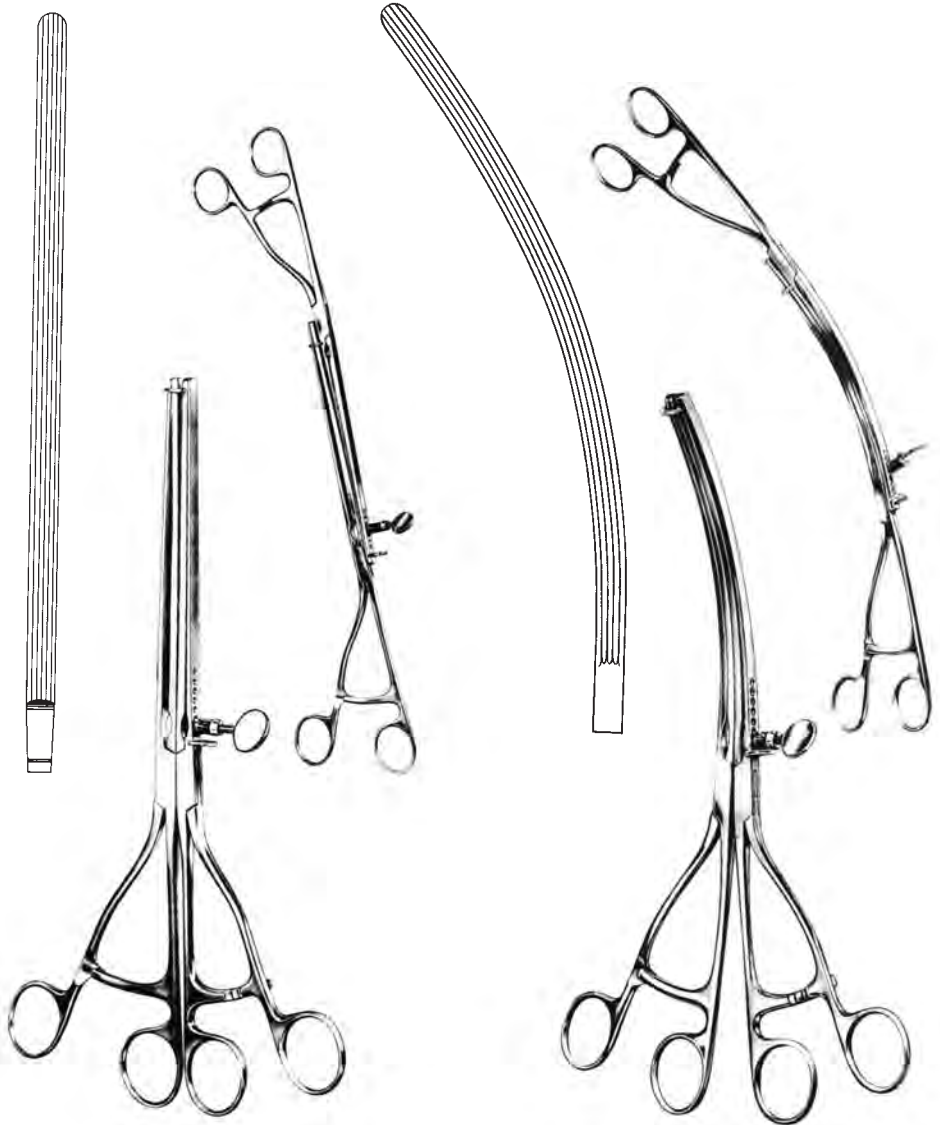

LANE
 65290-30 30 cm, 11 3/4"

LANE
 65291-30 30 cm, 11 3/4"

Darm- und Magenquetschklemmen
Intestinal and Stomach clamps
Pinzas-clamps intestinales y estomacales
Pinze e Schiacciatori per l'intestino e lo stomaco

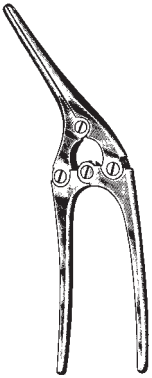

PAYR-BABY
65310-15
15 cm, 6"



PAYR

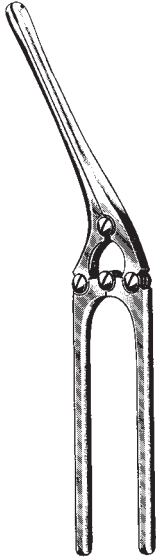

65310-21
21 cm, 8 1/4"



65310-29
29 cm, 11 1/2"



65310-35
35 cm, 14"

Magen- und Darmnähhapparat
 Stomach and Intestinal Suturing Apparatus
 Aparato para suturar estómago e intestinos
 Apparecchiature di sutura gastro-intestinale

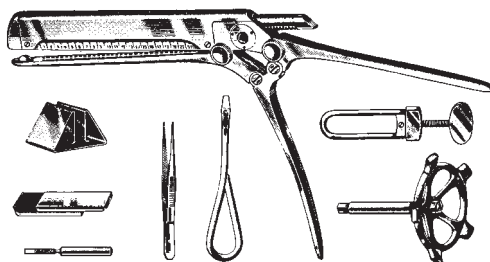

V. PETZ
 65320-00

komplett in Holzetui
 compl. in wooden case
 en estuche de madera
 in astuccio di legno

bestehend aus:

- Nähapparat
- Holzetui
- Zusatzschloß
- Kurbel
- Füllständer
- Füllstift
- Füllpinzette
- Schraubenzieher
- Etui für Klammern
- Silberklammern
(Pack à 300 Stck.)

consisting of:

- suturing apparatus
- wooden case
- additional closing clamp
- gear wheel
- filling rack
- filling pin
- filling tweezers
- screw driver
- metal box for clips
- silver suturing clips
(Pack of 300 ea.)

compuesto de:

- Aparator para suturar
- Estuche de madera
- Cierre adicional
- Manivela
- Soporte para rellenar
- Espiga para rellenar
- Pinza para rellenar
- Destornillador
- Estuche para agrafas
- Agrafas para sutura de plata
(Paquete de 300 pzas.)

composta da:

- apparecchio per la sutura
- astuccio in legno
- Serratura supplementare
- manovella
- supporto di riempimento agraiffe
- perno per posizionare le agraiffe
- pinza per caricare
- cacciavite
- scatola in metallo per agraiffe
- agraiffe in argento
(confezione da 300 pezz.)

Prostatahaken, Kapsel­faß­zange, Prostata­faß­zangen
 Prostatic Retractors, Grasping Forceps for the capsule - Anterior Lobe - and Ligature Carrier
 Separadores, Pinza para la próstata, para la cápsula, para lobo anterior, Porta-ligaduras
 Divaricatori, Pinza per afferrare la prostata - per la capsula, per lobo anteriore

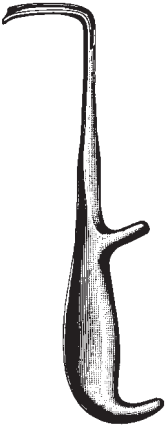

YOUNG
 67101-21
 21 cm, 8 1/4"



YOUNG
 67103-22
 22 cm, 8 3/4"



YOUNG
 67105-21
 21 cm, 8 1/4"



YOUNG
 67105-22
 22 cm, 8 3/4"

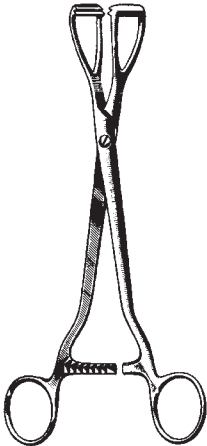

YOUNG
 67106-20
 20 cm, 8"

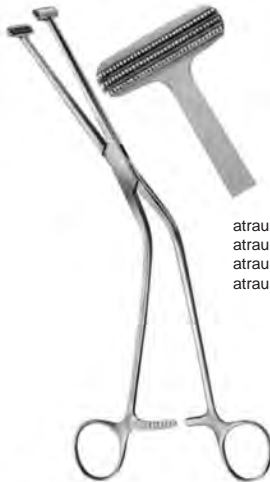

MILLIN
 67110-23
 23,5 cm, 9 1/4"

atrauma
 atraumatic
 atraumática
 atraumatica

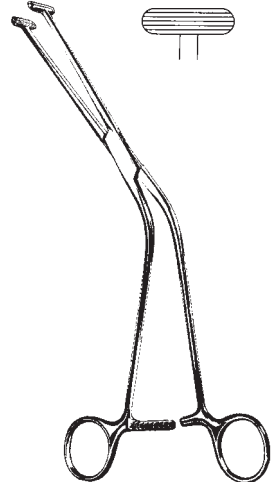

MILLIN
 67111-23
 23 cm, 9"

Kapselfaßzange, Prostatafaßzangen
 Grasping Forceps for the capsule - Anterior Lobe - and Ligature Carrier
 Pinza para la próstata, para la cápsula, para lobo anterior, Porta-ligaduras
 Pinza per afferrare la prostata - per la capsula, per lobo anteriore, Portafileo

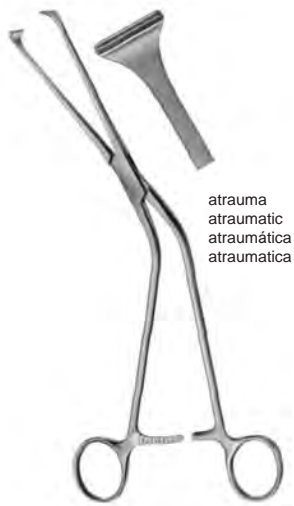

atrauma
 atraumatic
 atraumática
 atraumatica

MILLIN
 67122-23
 24,5 cm, 9 3/4"

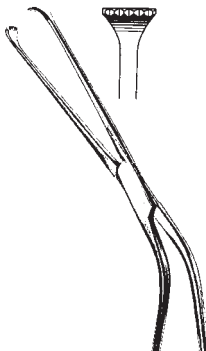

MILLIN
 67123-23
 23 cm, 9"



MILLIN
 67125-24
 24 cm, 9 1/2"

Prostatahaken, Blasenwundspreizer, Blasen spatel
 Prostatic Retractors, Bladder Retractors
 Separadores vesicales
 Divaricatori vescicali, Spatoli vescicali

- 67130-01 2 Valven, 2 blades, 2 valvas, 2 valve 57 mm x 25 mm
- 67130-02 2 Valven, 2 blades, 2 valvas, 2 valve 80 mm x 25 mm
- 67130-03 1 Valven, 1 blade, 1 valva, 1 valve 120 mm x 45 mm



MILLIN
67130-00

- 67130-00 ohne Kaltlicht
- 67132-00 Kaltlichtaufsatz für 67130-00
- 67130-00 without fiber optic
- 67132-00 fiber optic light carrier for 67130-00
- 67130-00 sin soporte de luz fría
- 67132-00 soporte de luz fría para 67130-00
- 67130-00 senza fibre ottiche
- 67132-00 supporto per luce fredda per 67130-00



LEGUEU
67147-27

KOCHER
67149-27



JUDD-MASSON

- 67150-00 mit Mittelvalve, with Central Blade
con valva centrale, con valva centrale
- 67155-00 ohne Mittelvalve, without Central Blade
sin valva central, senza valva centr.



THOMSON-WALKER
67160-00

Blasenwundspreizer, Blasenhalssperrer, Urethrotome
 Bladder Retractors, Bladder Neck Spreader, Urethrotomes
 Separadores vesicales, Uretrótomos
 Divaricatori vescicali, Divaricatore del collo vescicale, Uretrrotomi



LEGUEU
67163-00



MILLIN
67165-00

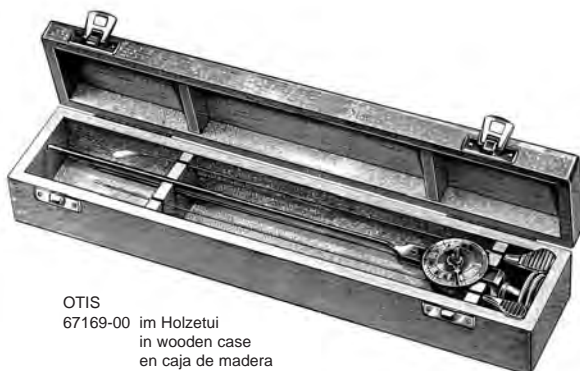

OTIS
67169-00 im Holzetui
in wooden case
en caja de madera
in contenitore di legno

67169-01 Ersatzblatt alleine
Blade only
Hoja de repuesto
Lame di ricambio

Fremdkörperzange, Penisklemmen
 Foreign Body Forceps, Penis Seizing Forceps
 Pinzas para cuerpos extraños, Compresores uretrales
 Pinze per corpi estranei, Serrapene

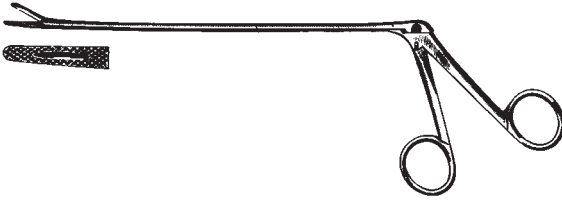

MATHIEU
 67172-20 20 cm, 8"
 67172-28 28 cm, 11"



STOCKMANN
 67175-08
 8 cm, 3 1/8"



STRAUSS
 67177-11
 11 cm, 4 3/8"

Vasektomie-Klemme
Vasectomy Forceps
Pinza para vasectomia
Pinza per vasectomia



67178-12
12 cm, 4 3/4"



3 mm

67178-14
14 cm, 5 1/2"



67179-14
14,5 cm, 5 3/4"

Kathetereinführungsinstrumente, Dilatationsbougies
 Catheter Introducer, Dilating Bougies
 Introducitor de catéteres, Bujías dilatadoras
 Mandrini per sonde uretrali, Candelette dilatatrici

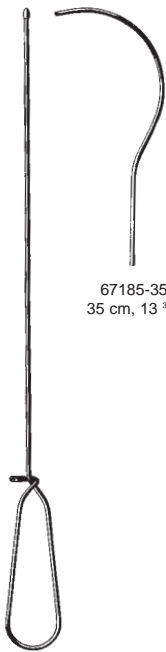

67185-35
 35 cm, 13 3/4"

GUYON
 67184-39
 39 cm, 15 1/2"

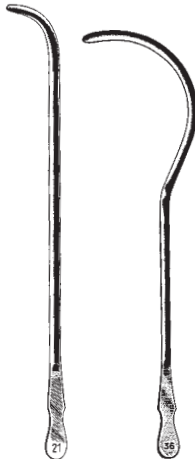

Charr.	28 cm (11")	25 cm (10")	28 cm (11")	30 cm (11 3/4")
8	VAN BUREN 67201-08	GUYON 67205-08	DITTEL 67206-08	DITTEL 67207-08
9			67206-09	67207-09
10	67201-10	67205-10	67206-10	67207-10
11			67206-11	67207-11
12	67201-12	67205-12	67206-12	67207-12
13			67206-13	67207-13
14	67201-14	67205-14	67206-14	67207-14
15			67206-15	67207-15
16	67201-16	67205-16	67206-16	67207-16
17			67206-17	67207-17
18	67201-18	67205-18	67206-18	67207-18
19			67206-19	67207-19
20	67201-20	67205-20	67206-20	67207-20
21			67206-21	67207-21
22	67201-22	67205-22	67206-22	67207-22
23			67206-23	67207-23
24	67201-24	67205-24	67206-24	67207-24
25			67206-25	67207-25
26	67201-26	67205-26	67206-26	67207-26
27			67206-27	67207-27
28	67201-28	67205-28	67206-28	67207-28
29			67206-29	67207-29
30	67201-30	67205-30	67206-30	67207-30
32	67201-32	67205-32		
34	67201-34	67205-34		
36	67201-36	67205-36		
38		67205-38		
40		67205-40		

Metalkatheter
Metal Catheters
Sondas metálicas
Sonde metalliche

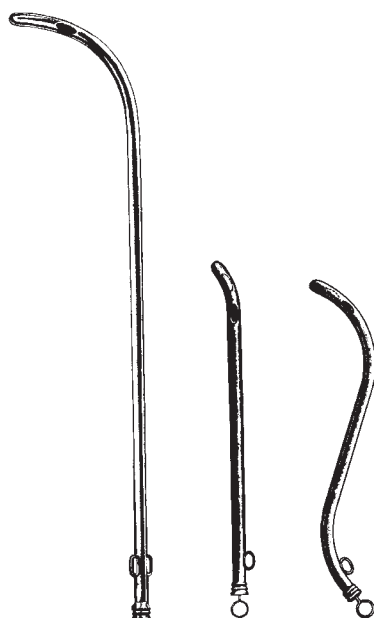

29 cm
11 1/2"

15 cm
6"

COXETER

Charr. FG			
6	67211-06	67213-06	
8	67211-08	67213-08	67219-08
10	67211-10	67213-10	67219-10
12	67211-12	67213-12	67219-12
14	67211-14	67213-14	67219-14
16	67211-16	67213-16	67219-16
18	67211-18	67213-18	67219-18
20	67211-20	67213-20	67219-20
22	67211-22	67213-22	67219-22
24	67211-24	67213-24	67219-24

Beschneidungsinstrument
 Circumcision Instrument
 Instrumentos para circuncisión
 Strumenti per circoncisione



67240-08	8 mm Ø
67240-11	11 mm Ø
67240-13	13 mm Ø
67240-16	16 mm Ø
67240-21	21 mm Ø
67240-26	26 mm Ø
67240-32	32 mm Ø

67240-08 - 67240-32



MOGEN

67250-07	7,5 cm (3")	2,5 mm
67251-07	7,5 cm (3")	1,5 mm
		für Kinder
		for children
		para niños
		per bambini

Mastdarm-Spekula
 Rectal Specula
 Espéculos rectales
 Specoli rettali



CZERNY
 69105-22
 22 cm, 8 3/4"



SIMS
 69110-15
 15 cm, 6"



BODENHAMMER
 69115-15
 15 cm, 6"

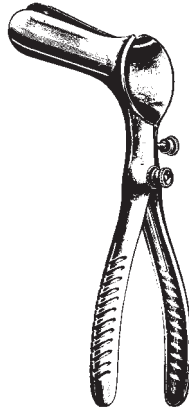

PRATT
 69121-00
 19 cm, 7 1/2"

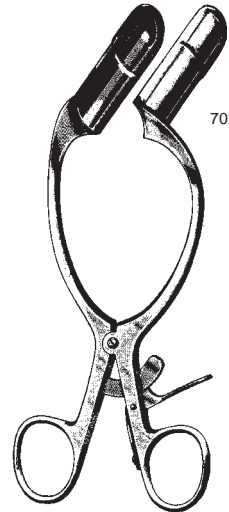

BARR
 69125-17
 17 cm, 6 3/4"

70x22 mm

Mastdarm-Spekula
 Rectal Specula
 Espécules rectales
 Specoli rettali



HILL-FERGUSON, 20 cm, 8"
 69126-01 6,4x2,2 cm 2 1/2" x 7/16"
 69126-02 7,6x3,0 cm 3" x 1 1/16"
 69126-03 7,6x3,6 cm 3" x 1 1/16"



SAWYER, 25 cm, 9 3/4"
 69127-01 6,4x2,2 cm 2 1/2" x 7/16"
 69127-02 7,6x2,9 cm 3" x 1 1/16"
 69127-03 8,9x3,8 cm 3 1/2" x 1 1/2"



MATHIEU
 69130-19
 19,5 cm, 7 3/4"



SCHULZE-BERGMANN
 69142-06 - 69142-12

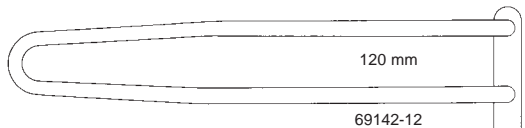
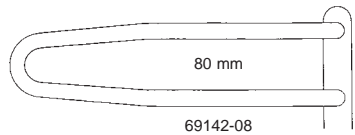
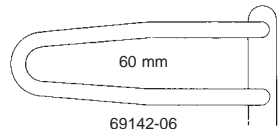

Analnspreizer
 Anal Retractors
 Separadores rectales
 Dilatatori per l'ano e il retto



ALAN-PARKS
 69147-00
 13,5 cm, 5 1/4"
 compl.

- 69147-02 Mittelblatt allein
 Center blade, only
 Valva central, solo
 Valva centrale, sola
- 69147-03 Blatt allein 75 mm, 3"
 Blade only 75 mm, 3"
 Valva sola 75 mm, 3"
 Valva sola 75 mm, 3"
- 69147-04 Blatt allein 95 mm, 3 3/4"
 Blade only 95 mm, 3 3/4"
 Valva sola 95 mm, 3 3/4"
 Valva sola 95 mm, 3 3/4"

69148-00
 Kaltlicht Zubehör für 69147-00
 Cold Light Attachment for 69147-00
 Adaptador para luz fría 69147-00
 Adattatore luce fredda per 69147-00

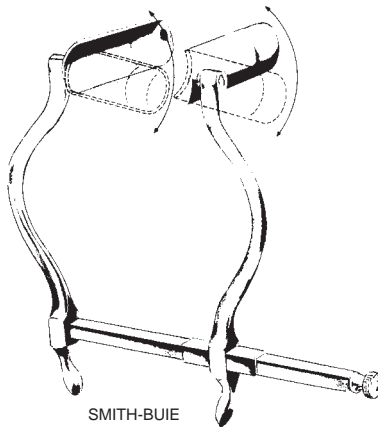

SMITH-BUIE
 69150-15
 15 cm, 6"
 75x23 mm

Anuskope, Proktoskope
 Anoscopes, Proctoscopes
 Anoscopios, Proctoscopios
 Anoscopi, Proctoscopi

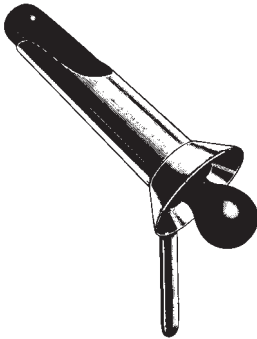

IVES-FANSLER
 69210-22 22 mm Ø
 L = 80 mm



Ø mm	HIRSCHMANN
16	69212-16
19	69212-19
22	69212-22
	L = 65 mm



mm	KELLY
ØxL	69220-05
22x 50	69220-10
22x100	69220-14
22x140	69220-20
22x200	

Anuskope, Proktoskope, Fistelsonde
 Anoscopes, Proctoscopes, Fistula Probe
 Anoscopios, Proctoscopios, Sondas para fistulas
 Anoscopi, Proctoscopi, Sonde per fistole



Ø mm KELLY
 21 69224-21
 27 69224-27
 L = 50 mm, 2"

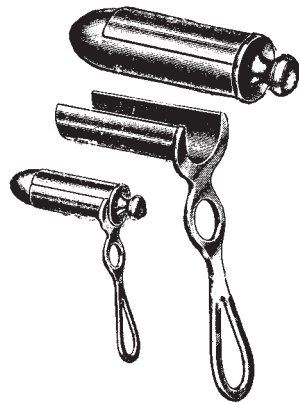

Ø mm CHELSEA-EATON
 22 x 65 69225-22
 30 x 65 69225-30



Fig. 1
 69251-01

Fig. 2
 69251-02

Fig. 3
 69251-03

PRATT
 21 cm, 8 1/4"
 69251-01 - 69251-03

Proktoskope
Proctoscopes
Proctoscopios
Protoscopi

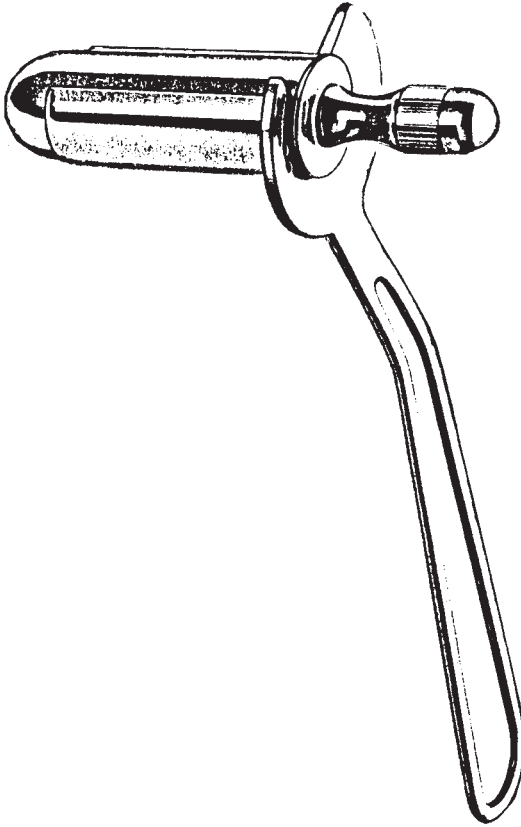

Ø	FANSLER, 24 cm, 9 1/2"
65 x 25 mm	69226-25
65 x 29 mm	69226-29
70 x 38 mm	69226-38

Proktoskope
Proctoscopes
Proctoscopios
Protoscopi



MORGAN		
69227-01	17 mm Ø	L=65 mm
69227-02	17 mm Ø	L=80 mm
69227-03	20 mm Ø	L=65 mm
69227-04	20 mm Ø	L=80 mm
69227-05	24 mm Ø	L=65 mm
69227-06	24 mm Ø	L=80 mm

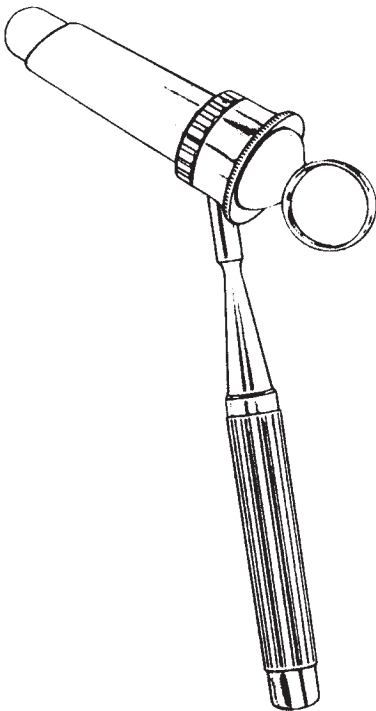

BENSAUDE		
69229-01	19 mm Ø	L=70 mm
69229-02	22 mm Ø	L=70 mm



69228-01

Beleuchtungsstab für Morgan
Illumination attachment for Morgan
Mango con iluminación para Morgan
Dispositivo Iluminativo per Morgan

Rektal Absaugrohr, Rektalschnürer, Mastdarmbiopsiezangen
 Rectal aspiration cannula, Rectal snare, Rectal Biopsy Specimen Forceps
 Cánula de aspiración rectal, Cierra-nudo rectal, Pinzas para biopsia rectal
 Cannula d'aspirazione rettale, Serranodi, Pinze taglianti per biopsia rettale

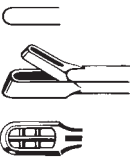
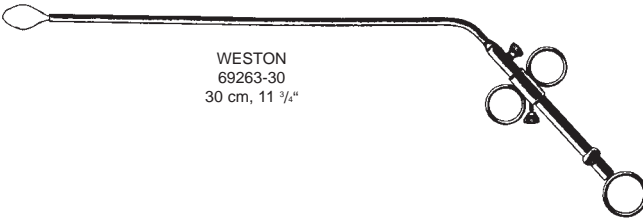
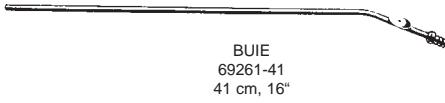

Fig. 1
 69301-28 28 cm, 11"
 69301-35 35 cm, 13 3/4"
 69301-42 42 cm, 16 1/2"

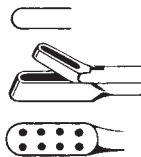

Fig. 2
 69302-28 28 cm, 11"
 69302-35 35 cm, 13 3/4"
 69302-42 42 cm, 16 1/2"

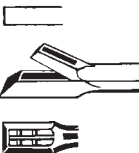

Fig. 3
 69303-28 28 cm, 11"
 69303-35 35 cm, 13 3/4"
 69303-42 42 cm, 16 1/2"

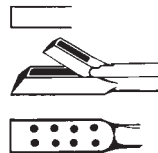
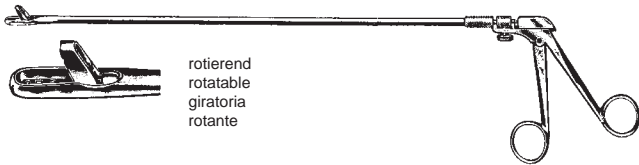

Fig. 4
 69304-28 28 cm, 11"
 69304-35 35 cm, 13 3/4"
 69304-42 42 cm, 16 1/2"

Mastdarm-Biopsiezangen rotierend, Hämorrhoidalzange
 Rectal Biopsy Specimen Forceps rotatable, Haemorrhoidal Forceps
 Pinzas para biopsia rectal, giratoria, Pinzas-clamps hemorroidales
 Pinze taglianti per biopsia rettale, rotante, Pinze per emorroidi



rotierend
 rotatable
 giratoria
 rotante

YEOMANN

69311-23 23 cm, 9"
 69311-33 33 cm, 13"
 69311-40 40 cm, 15 3/4"

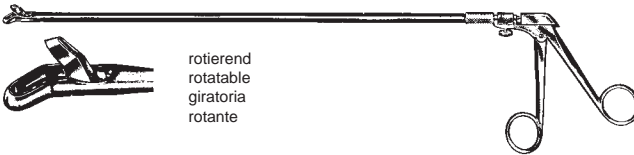

rotierend
 rotatable
 giratoria
 rotante

TURREL

69321-23 23 cm, 9"
 69321-33 33 cm, 13"
 69321-40 40 cm, 15 3/4"

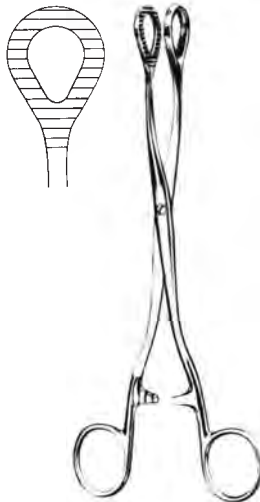

HEYWOOD-SMITH

69402-21 21 cm, 8 1/4"
 69402-25 25 cm, 10"

Hämorrhoidal-Ligatoren, Hämorrhoidalzangen
 Haemorrhoidal Ligators, Haemorrhoidal Forceps
 Ligadores para hemorroides, Pinzas-clamps para hemorroides
 Legatori emorroidali, Pinze per emorroidi

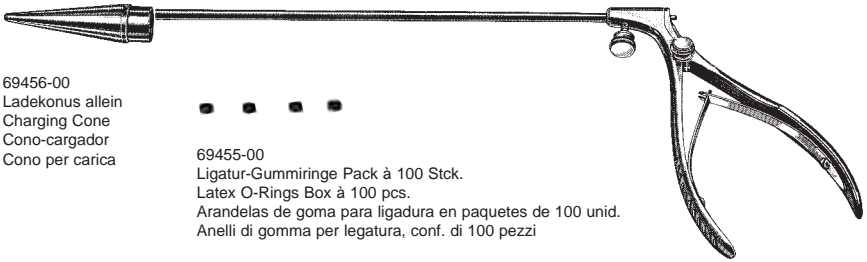

69456-00
 Ladekonus allein
 Charging Cone
 Cono-cargador
 Cono per carica



69455-00
 Ligatur-Gummiringe Pack à 100 Stck.
 Latex O-Rings Box à 100 pcs.
 Arandelas de goma para ligadura en paquetes de 100 unid.
 Anelli di gomma per legatura, conf. di 100 pezzi

MC GIVNEY
 LI GATOR
 69450-18
 18 cm, 7"



69457-12
 Ø 12 mm

RUDD
 69457-31
 31,5 cm, 12 1/2"
 kplt./cplt.

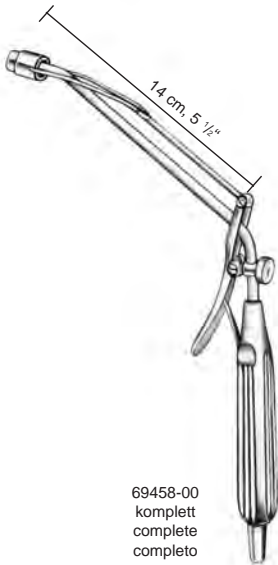

69458-00
 komplett
 complete
 completo



Ø 10 mm
 69458-10
 Ladekonus
 Charging cone
 Cono-cargador
 Cono per carica



Ø 10 mm
 69458-11 11 mm
 69458-16 16 mm
 Saugkopf
 Aspiration tip
 Cabeza de aspiración
 Testa d'aspirazione

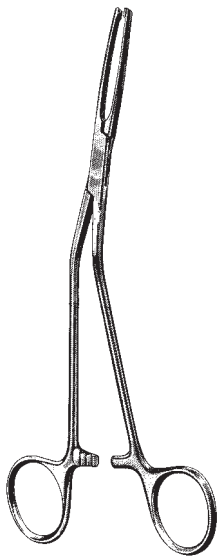

MC GIVNEY
 69460-00
 19 cm, 7 1/2"

Lateral-Scheidenspekula
 Lateral Vaginal Retractor
 Espéculos vaginales
 Specoli vaginali



71100-00

Lateralspreizer allein
 Vaginal retractor lateral only
 Espéculo vaginal solo
 Specolo vaginale laterale, solo

VU-MORE

Fig.	mm	
2	95x35	71115-02
3	115x35	71115-03

Scheidenspekula
Vaginal Specula
Espéculos vaginales
Specoli vaginali

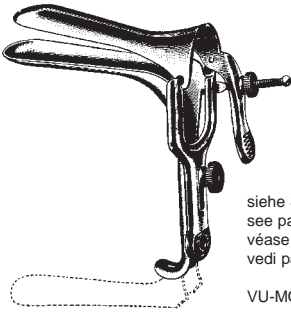

siehe Seite 569
see page no. 569
véase pagina no. 569
vedi pagina nr. 569

VU-MORE

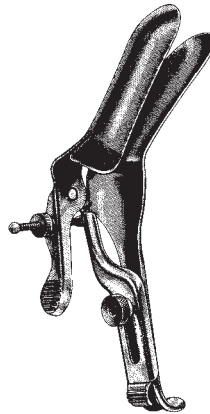

rechts offen
open right-side
abierto a la derecha
aperta a destra

GRAVE

71116-02

mittel, medium, mediano, medio
101x35 mm

GRAVE

Fig.	mm	Standard
1	75x20	71110-01
2	95x35	71110-02
3	115x35	71110-03

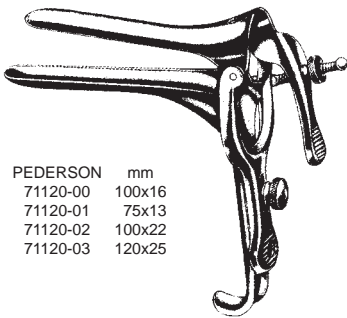

Fig.	PEDERSON	mm
	71120-00	100x16
1	71120-01	75x13
2	71120-02	100x22
3	71120-03	120x25

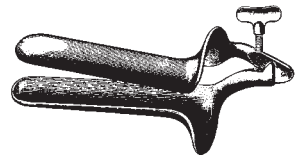
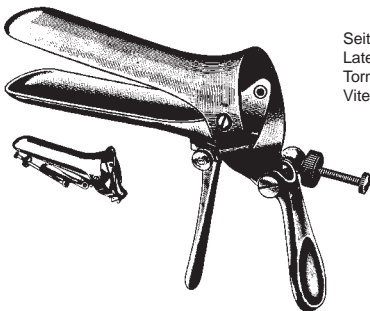

Fig.	COLLIN	mm
1	71130-01	85x30
2	71130-02	100x35
3	71130-03	110x40



Seitliche Schraube
Lateral Screw
Tornillo lateral
Vite laterale

CUSCO

Fig.	mm	Standard
1	75x32	71140-01
2	85x35	71140-02
3	100x35	71140-03
4	75x17	71142-04

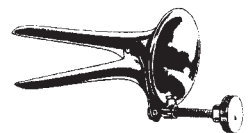

COLLIN
71132-00
65x10 mm

für Jungfrauen
for virgin
para vírgenes
per vergini

Scheidenspekula
Vaginal Specula
Espécules vaginales
Specoli vaginali

Mittelschraube
Central Screw
Tornillo central
Vite centrale

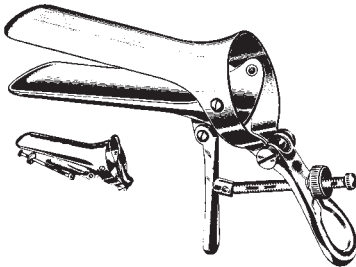

Fig.	CUSCO	mm
1	71150-01	75x32
2	71150-02	85x35
3	71150-03	100x37

Schweizer Modell
Swiss Pattern
Modelo suizo
Modello svizzero

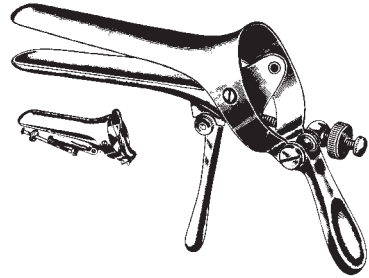
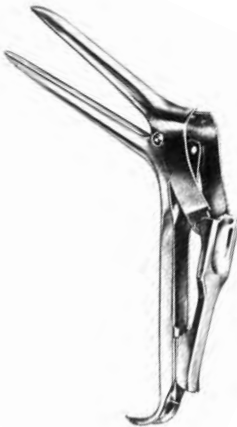

Fig.	CUSCO	mm
1	71160-01	90x23-25
2	71160-02	100x25-27
3	71160-03	110x27-30



	SEMM	mm
71161-17	100 x 17 - 20	mm
71161-25	100 x 25 - 30	mm

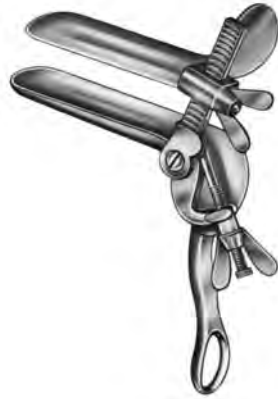

Fig.	TRÉLAT	mm
1	71170-01	85x33
2	71170-02	95x35
3	71170-03	115x43

Scheidenspekula
Vaginal Specula
Especulos vaginales
Specoli vaginali

Satz bestehend aus je 1 Spekula und 1 Halter
Set consisting of 1 specula and 1 retractor
Juego de 1 espéculo y 1 valva
Serie da 1 specolo e 1 valva

Spekula
Speculum
Especulo
Specolo

Halter
Retractor
Valva
Valve



Fig. KRISTELLER
1 71210-01
2 71210-02
3 71210-03



Fig. KRISTELLER mm
1 71211-01 70x27
2 71211-02 80x30
3 71211-03 90x36



Fig. KRISTELLER mm
1 71212-01 75x23
2 71212-02 85x26
3 71212-03 100x32



Fig. KRISTELLER
00 71240-00
0 71240-10
1 71240-01
2 71240-02
3 71240-03

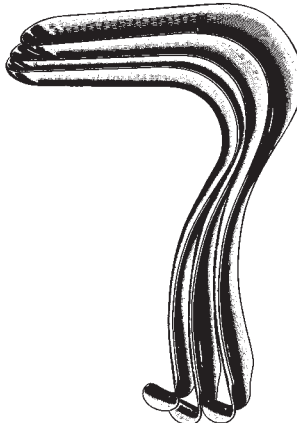

Fig. KRISTELLER mm
00 71241-00 110x18
0 71241-10 110x21
1 71241-01 110x27
2 71241-02 110x30
3 71241-03 110x36

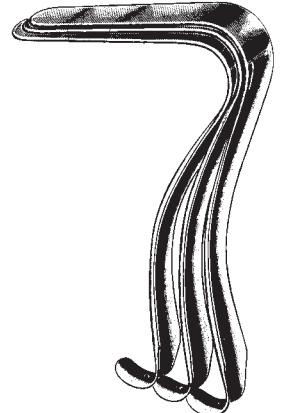

Fig. KRISTELLER mm
00 71242-00 115x14
0 71242-10 115x17
1 71242-01 115x23
2 71242-02 115x26
3 71242-03 115x32

Scheidenspekula
Vaginal Specula
Espéculos vaginales
Specoli vaginali



KALLMORGEN
71260-01 - 71262-02

Fig.	Satz Set Juego Serie	Spekula Speculum Espéculo Specolo	Halter Retractor Valva	mm
1	71260-01	71261-01	71262-01	70x33
2	71260-02	71261-02	71262-02	90x33



JACKSON

Fig.	SIMS	mm
1	71271-01	75x38
2	71271-02	90x38
3	71271-03	100x38



SIMS

Fig.	SIMS	mm
1	71281-01	63x32
2	71281-02	76x32
3	71281-03	89x38

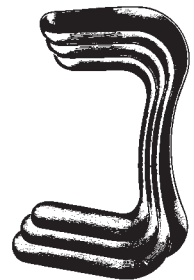

SIMS

Fig.	SIMS	mm
1	71291-01	60x25+30
2	71291-02	70x30+35
3	71291-03	80x35+40

Set 71291-00 (Fig. 1,2,3)

Scheidenspekula
 Vaginal Specula
 Espécúlos vaginales
 Specoli vaginali



DELEE
 71300-01
 23,5 cm, 9 1/4"

leicht hohl
 slightly concave
 ligeramente concavos
 leggermente concavi

Fig.		mm
1	71301-01	55x35
2	71301-02	85x35
3	71301-03	115x35

Fig.		mm
1	71303-01	55x45
2	71303-02	85x45
3	71303-03	115x45
4	71303-04	160x45
5	71303-05	180x45

Fig.		mm
1	71305-01	55x60
2	71305-02	85x60
3	71305-03	115x60
4	71305-04	160x60
5	71305-05	180x60



35 mm
 1.4"



45 mm
 1.8"



60 mm
 2.4"

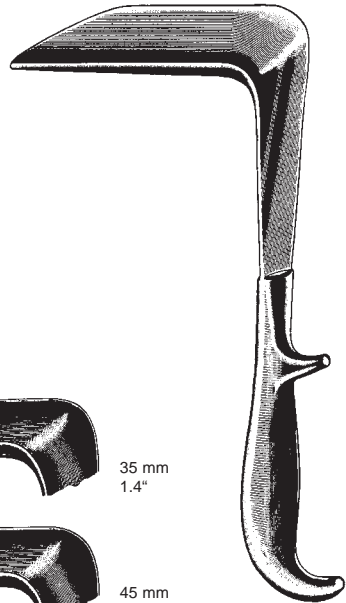

DOYEN
 24 cm, 9 1/2"

Scheidenspekula
Vaginal Specula
Espéculos vaginales
Specoli vaginali

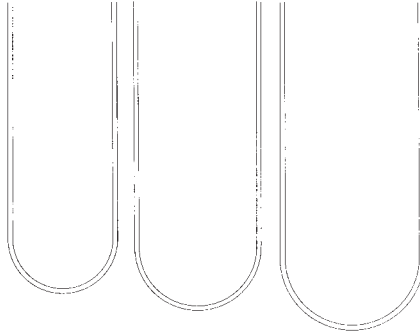
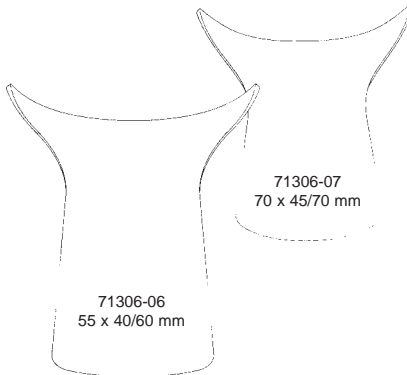

71306-01 - 71306-03

71306-01
80 x 30 mm71306-02
85 x 35 mm71306-03
90 x 40 mm71306-04
Gewicht 400 gr
weight 400 grs
peso 400 grs
peso 400 grs71306-05
Gewicht 800 gr
weight 800 grs
peso 800 grs
peso 800 grs71306-07
70 x 45/70 mm71306-06
55 x 40/60 mmSCHERBAK
71306-00
Set komplett
complete set
juego completo
set completo71306-08
Griff, handle,
mango, manico

Scheidenspekula
 Vaginal Specula
 Espéculos vaginales
 Specoli vaginali



O'SULLIVAN-O'CONNOR
 71308-00

Fig. 1 = 45 x 17 mm 71308-01
 Fig. 2 = 90 x 37 mm 71308-02
 Fig. 3 = 90 x 45 mm 71308-03

71308-04
 Rahmen allein
 Frame only
 Marco solo
 Telaio solo

71308-00

komplett bestehend aus:

1 Rahmen mit 2 beweglichen Seitenvalven
 3 austauschbare Mittelvalven Fig. 1-3

1 frame with 2 mobile lateral blades
 3 interchangeable blades Fig. 1-3

1 Marco con 2 separadores móviles laterales
 3 separadores centrales intercambiables fig. 1-3

1 telaio regolabile con 2 valve laterali mobili
 3 valve intercambiabili fig. 1-3

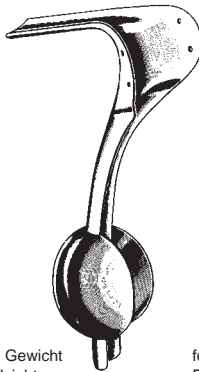

abnehmbares Gewicht
 Detachable Weight
 Peso desmontable
 Peso smontabile

71307-00
 1,4 kg
 75 x 38 mm

AUVARD
 24 cm, 9 1/2"

festes Gewicht
 Fixed Weight
 Peso fijo
 Peso fisso

71309-00
 1,4 kg
 105 x 38 mm

Scheidenspekula, Endospekula
 Vaginal Specula, Endospecula
 Espéculos vaginales, Endo-espéculos
 Specoli vaginali, Endospecoli



mm	BREISKY	
100x20	71310-20	28 cm, 11"
100x25	71310-25	28 cm, 11"
100x30	71310-30	28 cm, 11"
100x35	71310-35	28 cm, 11"
100x40	71310-40	28 cm, 11"
130x20	71313-20	33 cm, 13"
130x25	71313-25	33 cm, 13"
130x30	71313-30	33 cm, 13"
130x35	71313-35	33 cm, 13"
130x40	71313-40	33 cm, 13"
155x40	71315-40	35 cm, 13 3/4"



mm	LANDAU	
100x28	71319-28	29 cm, 11 1/2"
100x38	71319-38	29 cm, 11 1/2"

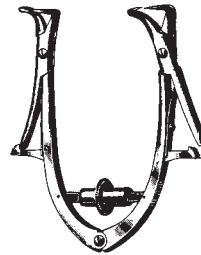

FRIEDMANN	
71351-15	15 cm, 6"



	KOGAN	
71360-24	3 mm	24 cm, 9 1/2"
71361-24	4 mm	24 cm, 9 1/2"
71362-24	5 mm	24 cm, 9 1/2"



	KOGAN	
71363-24	3 mm	24 cm, 9 1/2"
71364-24	4 mm	24 cm, 9 1/2"
71365-24	5 mm	24 cm, 9 1/2"

Uterus Dilatoren
 Uterine Dilators
 Dilataores uterinos
 Dilattatori uterini

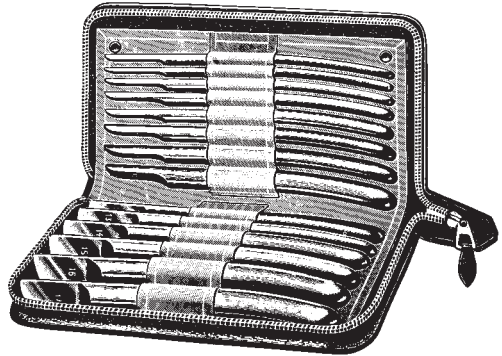

mm Ø	HEGAR		mm Ø
1	71410-01	71415-01	1,5
2	71410-02	71415-02	2,5
3	71410-03	71415-03	3,5
4	71410-04	71415-04	4,5
5	71410-05	71415-05	5,5
6	71410-06	71415-06	6,5
7	71410-07	71415-07	7,5
8	71410-08	71415-08	8,5
9	71410-09	71415-09	9,5
10	71410-10	71415-10	10,5
11	71410-11	71415-11	11,5
12	71410-12	71415-12	12,5
13	71410-13	71415-13	13,5
14	71410-14	71415-14	14,5
15	71410-15	71415-15	15,5
16	71410-16	71415-16	16,5
17	71410-17	71415-17	17,5
18	71410-18	71415-18	18,5
19	71410-19	71415-19	19,5
20	71410-20		
21	71410-21		
22	71410-22		
23	71410-23		
24	71410-24		
25	71410-25		
26	71410-26		
27	71410-27		
28	71410-28		
29	71410-29		
30	71410-30		

HEGAR
 71405-14 4-17 mm
 14 St./pces./pzas./pezzi

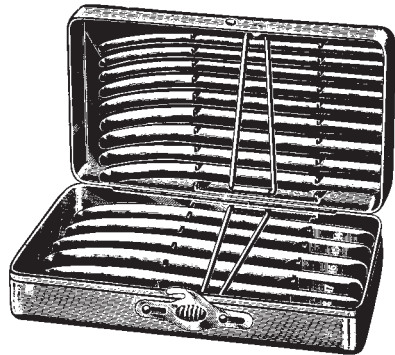

mm HEGAR
 4-17 71406-14 14 St./pces./pzas./pezzi
 1-26 71406-26 26 St./pces./pzas./pezzi

71404-14 Satz/Set/Juego/Set
 71410-04 - 71410-17 = 14
 71404-26 Satz/Set/Juego/Set
 71410-01 - 71410-26 = 26

in Metalluet, in metal case,
 en estuche de metal, in astuccio metallico

Uterus Dilatoren
 Uterine Dilators
 Dilatadores uterinos
 Dilatatori uterini



mm	HEGAR
1/ 2	71420-01
3/ 4	71420-03
5/ 6	71420-05
7/ 8	71420-07
9/10	71420-09
11/12	71420-11
13/14	71420-13
15/16	71420-15
17/18	71420-17
19/20	71420-19
21/22	71420-21
23/24	71420-23
25/26	71420-25

71424-08 Satz/Set/Juego/Set
 71420-03 - 71420-17 = 8
 3/4 - 17/18 mm

71424-13 Satz/Set/Juego/Set
 71420-01 - 71420-25 = 13
 1/2 - 25/26 mm

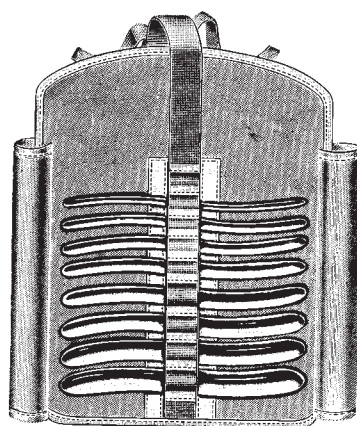

mm HEGAR
 3/4 - 17/18 71425-08 8 St./pces./pzas./pezzi

in Stofftasche, in khaki roll,
 en bolsa de tela, in borsa di tela

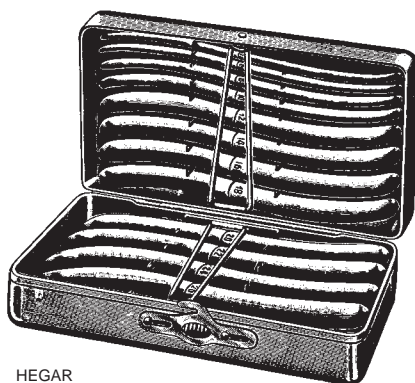

mm HEGAR
 3-4 - 17/18 71426-08 8 St./pces./pzas./pezzi
 1/2 - 25/26 71426-13 13 St./pces./pzas./pezzi

in Metalltui, in metal case,
 en estuche de metal, in astuccio metallico

Uterus Dilatoren
 Uterine Dilators
 Dilatores uterinos
 Dilatori uterini



in Stofftasche
 in khaki roll
 en bolsa de tela
 in borsa di tela

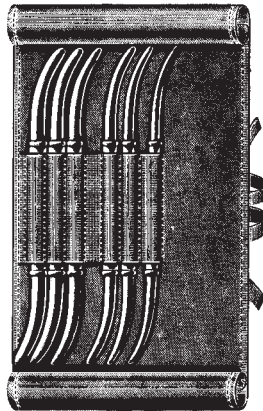

mm	HANK	Fig./U.S.
4,5/ 5	71430-10	9/10
5,5/ 6	71430-12	11/12
6,5/ 7	71430-14	13/14
7,5/ 8	71430-16	15/16
8,5/ 9	71430-18	17/18
9,5/10	71430-20	19/20

71435-06 Satz, Set, Juego, Serie = 6

HANK
 71436-08
 Satz, Set, Juego, Serie = 6

PRATT		
71438-13 - 71438-41		
71438-00		
Satz, Set, Juego, Set = 8		
size	mm	
71438-13	13-15	4,5/ 5,0
71438-17	17-19	5,6/ 6,3
71438-21	21-23	7,0/ 7,6
71438-25	25-27	8,3/ 9,0
71438-29	29-32	9,6/10,3
71438-33	33-35	11,0/11,6
71438-37	37-39	12,3/13,0
71438-41	41-43	13,6/14,3

Uterus Dilatorem
 Uterine Dilators
 Dilatadores uterinos
 Dilatatori uterini

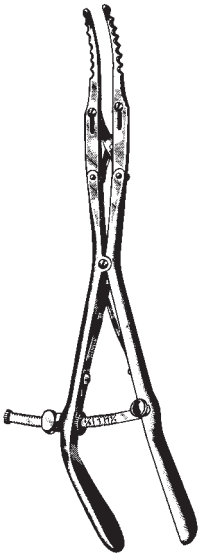

GOODELL
 71441-34
 34 cm, 13 1/2"

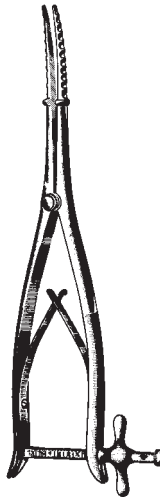

WYLIE
 71443-29
 29 cm, 11 1/2"

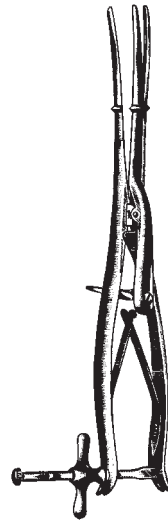

SIMS
 71445-29
 29 cm, 11 1/2"

Hakenzangen

Tenaculum Forceps

Pinzas para coger el cuello del útero

Pinze per abbassare il collo dell'utero

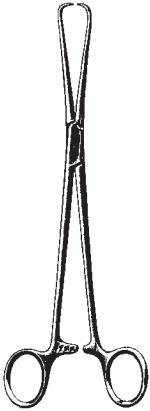

SCHRÖDER (POZZI)
71502-25
25 cm, 10"

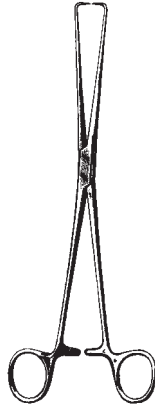

BRAUN
71504-25
25 cm, 10"



SKENE
71505-24
24 cm, 9 1/2"

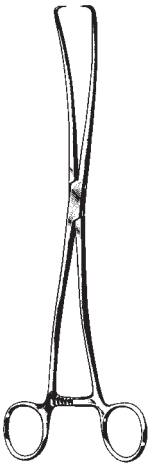

DUPLAY
71507-28
28 cm, 11"

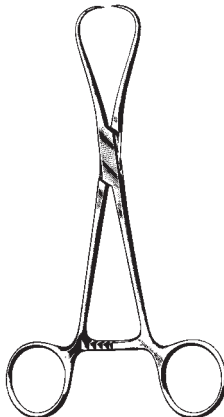

STAUDE-MOORE
71508-17
17 cm, 6 3/4"

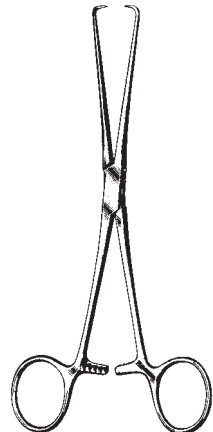

BARRETT
71510-18
18 cm, 7"

Hakenzangen
 Tenaculum Forceps, Vulsellum Forceps
 Pinzas para coger el cuello del útero
 Pinze per abbassare il collo dell'utero

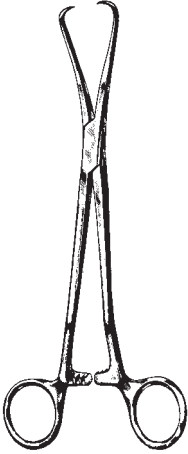

JARCHO
 71512-20
 20 cm, 8"

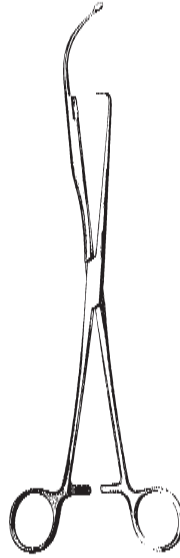

HULKA
 71512-28
 28 cm, 11"

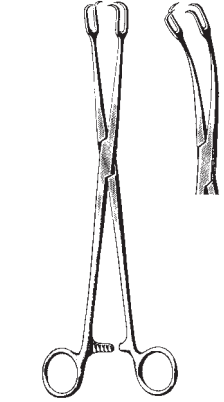

SCHRÖDER
 71514-24 71515-24
 24 cm, 9 1/2"

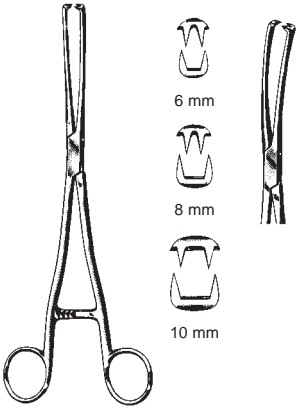

MUSEUX
 71524-06 6 mm 71525-06
 71524-08 8 mm 71525-08
 71524-10 10 mm 71525-10
 24 cm, 9 1/2"

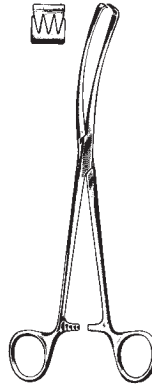

TEALE
 71531-23
 23 cm, 9"

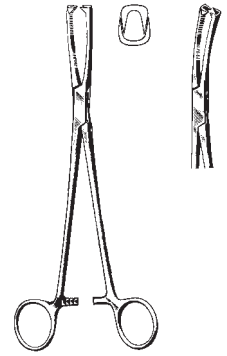

JACOBS
 71532-21 71533-21
 21 cm, 8 1/4"

Hakenzangen

Tenaculum Forceps, Vulsellum Forceps

Pinzas para coger el cuello del útero

Pinze per abbassare il collo dell'utero

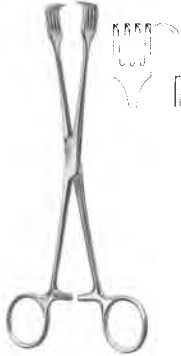

CZERNY
71536-21
20 cm, 8"



PRATT
71536-28
28 cm, 11"



SCHRÖDER
71537-27
27 cm, 10 1/2"

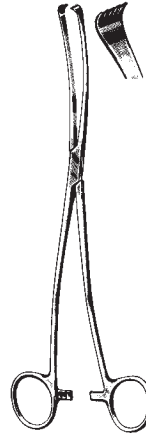

IOWA
71539-26
26 cm, 10 1/4"

Uterus Polypenzangen, Uterus-Faßzangen
 Uterine Polypus Forceps, Uterine Elevating Forceps
 Pinzas para pólipos uterinos, Pinzas para el útero
 Pinze per polipi uterini, Pinze per afferrare l'utero

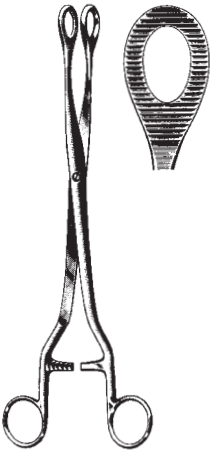

NOTO
 71540-27
 27 cm, 10 1/2"

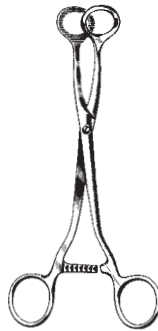

DOYEN
 71542-20
 20 cm, 8"

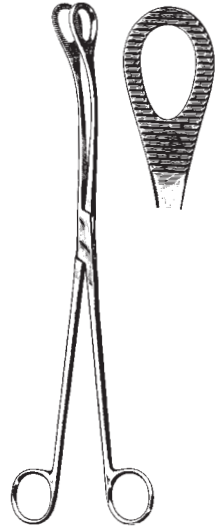

KELLY
 71543-32
 32 cm, 12 1/4"



DARTIGUES
 71545-27
 27 cm, 10 1/2"

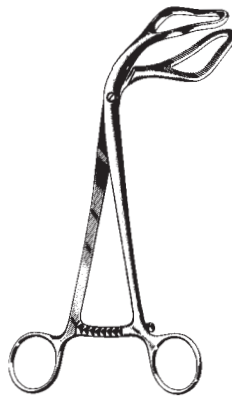

SOMER
 71547-23
 23 cm, 9"

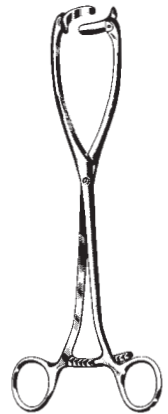

COLLIN
 71549-25
 25 cm, 10"

Amniotom, Uterus Depressoren, Uterus-Sonden
 Amniótome, Uterine Depressors, Uterine Sounds
 Amniótomo, Depresores uterinos, Histerómetros
 Amniotomo, Depressori uterini, Isterometri



BEACHAM
 71559-26
 26 cm, 10 1/4"



BRAUN
 71565-28
 28 cm, 11"



SIMS
 71567-26
 26 cm, 10 1/4"



fest
 rigid
 rigido
 rigida
 71580-32
 32 cm, 12 3/4"

biegsam
 malleable
 maleable
 malleabile
 71581-32

SIMS



fest
 rigid
 rigido
 rigida
 71582-32
 32 cm, 12 3/4"

biegsam
 malleable
 maleable
 malleabile
 71583-32

MARTIN



COLLIN
 71584-28
 28 cm, 11"



VALLEIX
 71585-25
 25 cm, 10"

Biopsie-Küretten
 Uterine Biopsy Aspirating Curettes
 Curetas aspiradoras p. la biopsia uterina
 Curette per biopsia



RANDALL
 71590-04
 24 cm, 9 1/2"
 Ø 4 mm



NOVAK
 71592-01 1 mm
 71592-02 2 mm
 71592-03 3 mm
 71592-04 4 mm



HEANY
 71593-00
 22,5 cm, 9"



71594-40



71596-40

KEVORKIAN
 4,0 mm
 30 cm, 11 3/4"
 ohne Korb
 without basket
 sin cesta
 senza cestello
 71594-40

 mit Korb
 with basket
 con cesta
 con cestello
 71596-40



MOD. MUENCHEN
 71598-27
 27 cm, 10 1/2"



Biopsiezangen
 Biopsy Forceps
 Pinzas para biopsia
 Pinze taglianti per biopsia



SCHUMACHER
 24 cm, 9 1/2"



SCHUBERT
 71604-21 21 cm, 8 1/4"
 71604-28 28 cm, 11"

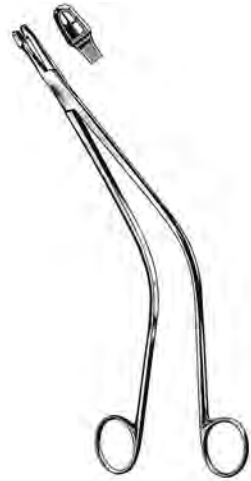

SCHUBERT
 71605-26 26 cm, 10 1/4"
 71605-28 28 cm, 11"



THOMAS-GAYLOR
 71606-24
 24 cm, 9 1/2"



van DOREN
 71611-25
 25 cm, 10"



FAURE
 71612-21
 21 cm, 8 1/4"

Uterus Biopsiezangen
 Biopsy Specimen Forceps
 Pinzas para biopsia
 Pinze per biopsia

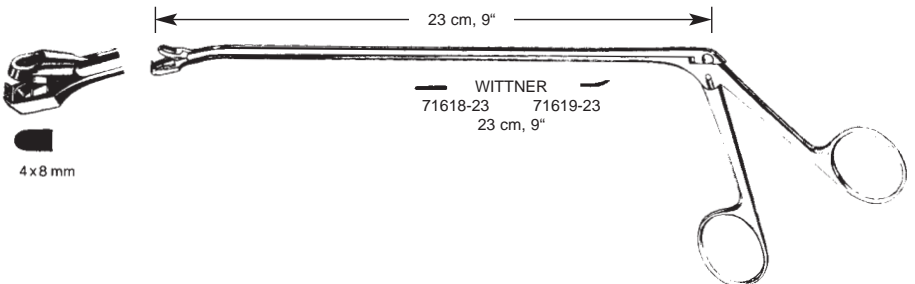
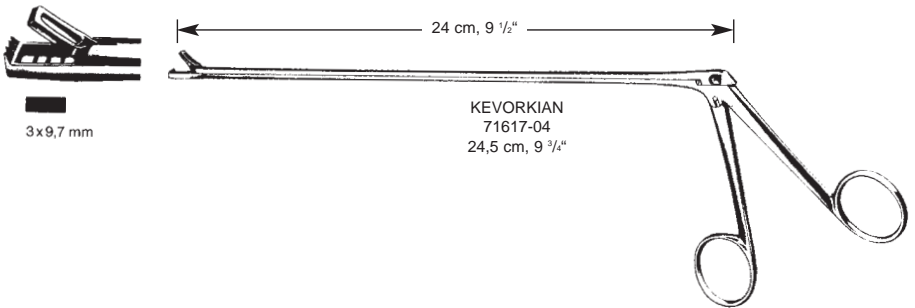
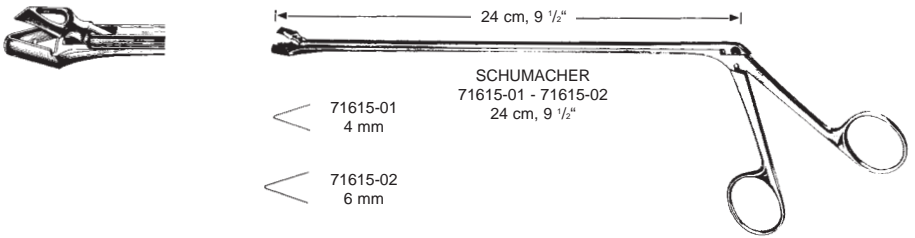
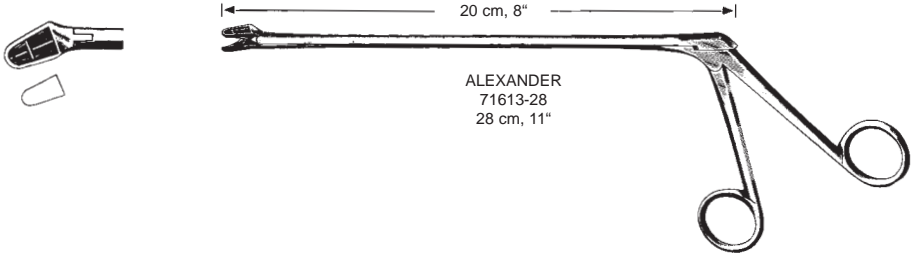

Uterus Biopsiezangen
 Biopsy Specimen Forceps
 Pinzas sacabocado p. biopsia
 Pinze per biopsia

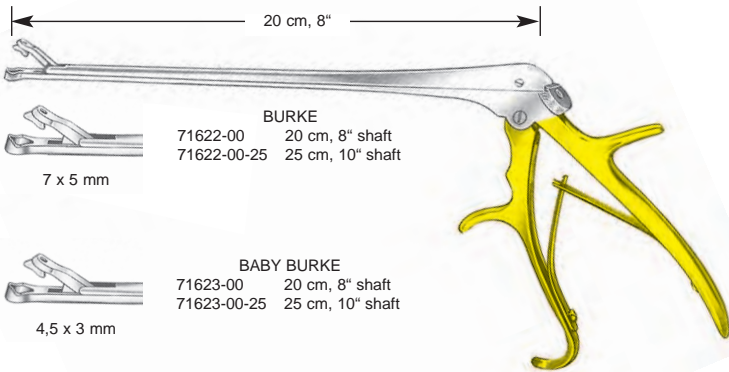
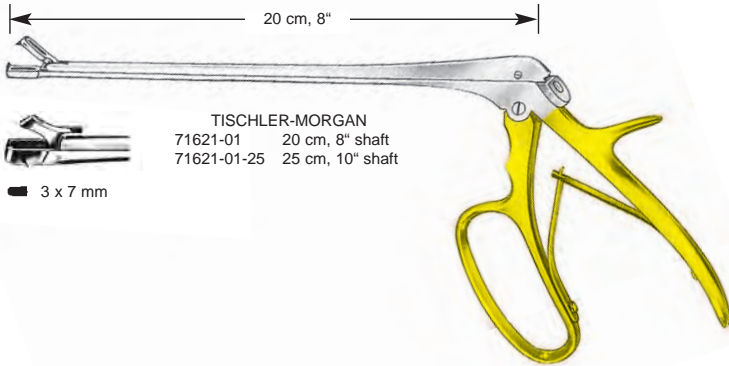
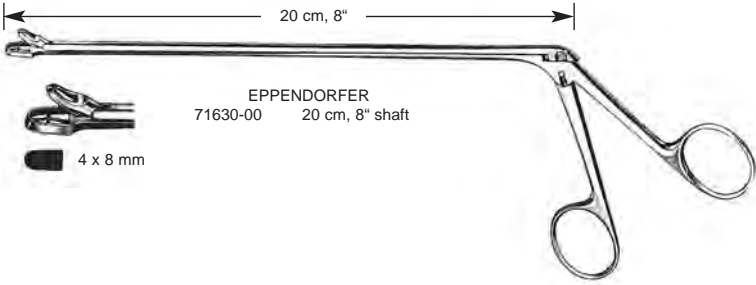

Uterus Biopsiezangen
Biopsy Specimen Forceps
Pinzas sacabocado p. biopsia
Pinze per biopsia

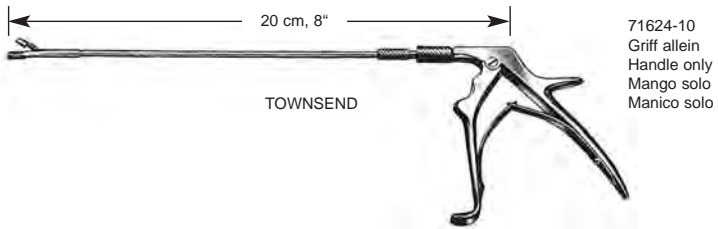

Fig. 1

TISCHLER-Morgan



Fig. 6

TISCHLER-UP



Fig. 3

oval ● 3,7x5 mm



Fig. 7

TISCHLER-DOWN



Fig. 4

KEVORKIAN



Fig. 8

MINI-TOWNSEND-UP



Fig. 5

mini

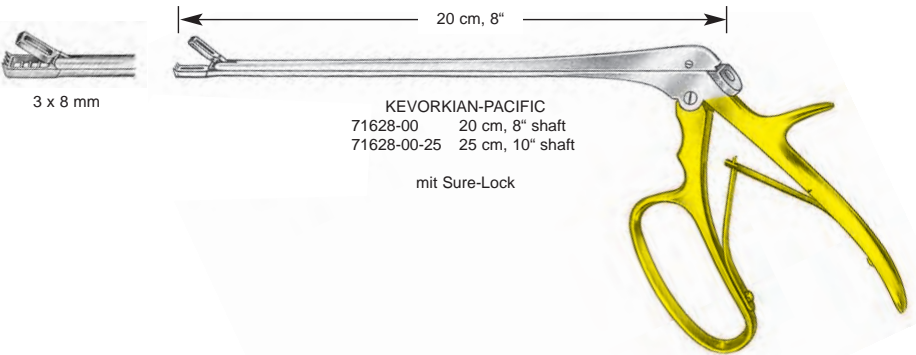
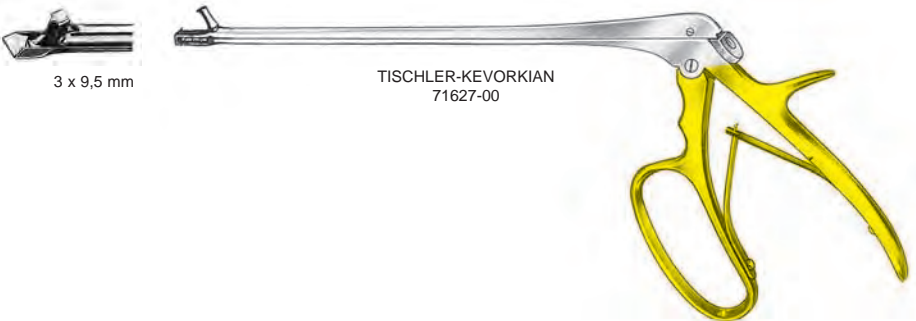
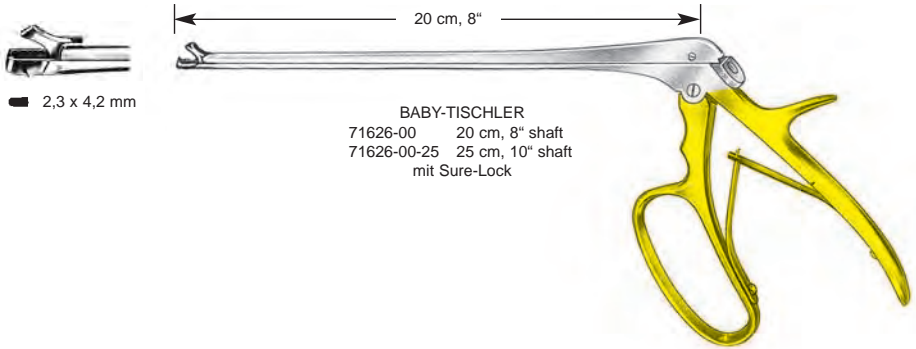

Fig. 9

MINI-TOWNSEND-DOWN

	komplett compl. instr. Instrum. compl.	Aufsatz allein Tip only Punta sola
Fig. 1	Strumento completo	Asta operativa sola
1	71624-01	71624-11
3	71624-03	71624-13
4	71624-04	71624-14
5	71624-05	71624-15
6	71624-06	71624-16
7	71624-07	71624-17
8	71624-08	71624-18
9	71624-09	71624-19

Uterus Biopsiezangen
 Biopsy Specimen Forceps
 Pinzas sacabocado p. biopsia
 Pinze per biopsia



Uterus Biopsiezangen
 Biopsy Specimen Forceps
 Pinzas sacabocado p. biopsia
 Pinze per biopsia

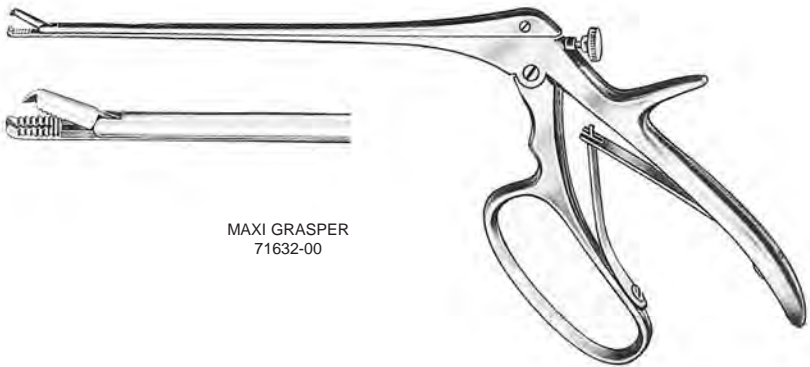

MAXI GRASPER
 71632-00

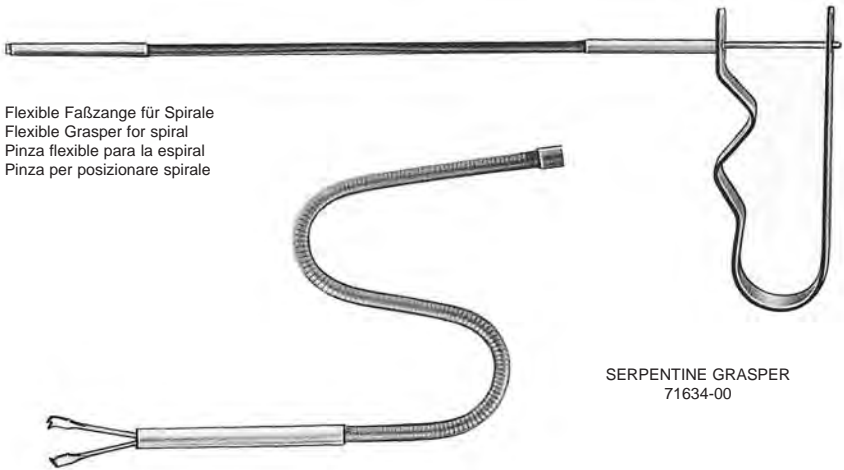

Flexible Faßzange für Spirale
 Flexible Grasper for spiral
 Pinza flexible para la espiral
 Pinza per posizionare spirale

SERPENTINE GRASPER
 71634-00



I.U.D.
 Extractor Hook
 71635-26
 26 cm, 10 1/4"

Myomheber, Myommesser, Fistelhäkchen, Meßinstrumente, Uteruslöffel
 Myoma Screw, Myoma Knife, Fistula Hook, Measuring Instruments, Uterine Curettes
 Tirabuzón para fibromas, Bisturi para fibromas, Ganchos para fistulas, Instrumental para medir, Curetas uterinas
 Tiramiomi, Bisturi per fibromi, Uncini per fistole, Strumenti per misure, Curette uterine



DOYEN
 71641-17
 17 cm, 6 3/4"

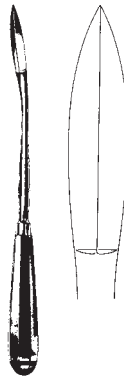

SEGOND
 71643-27
 27 cm, 10 1/2"

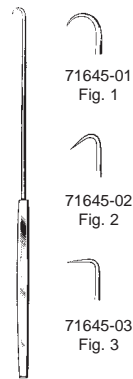

EMMET
 71645-01 - 71645-03
 22 cm, 8 3/4"

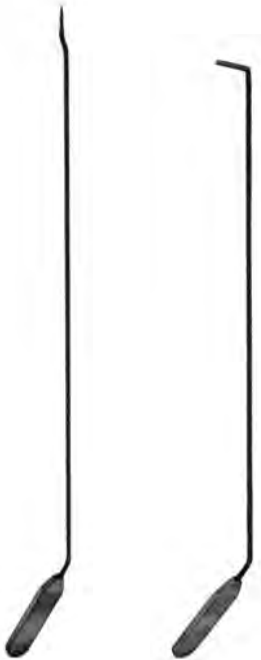

71646-01

71646-02

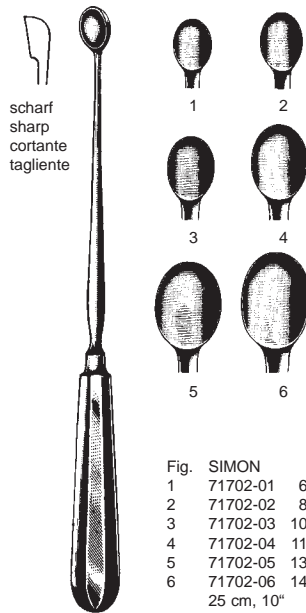

scharf
 sharp
 cortante
 tagliente

Fig. SIMON
 1 71702-01 6,8 mm
 2 71702-02 8,5 mm
 3 71702-03 10,0 mm
 4 71702-04 11,5 mm
 5 71702-05 13,0 mm
 6 71702-06 14,5 mm
 25 cm, 10"

Uterus-Küretten
 Uterine Curettes
 Curetas uterinas
 Curette uterine



SCHRÖDER
 31 cm, 12 1/4"



71703-01
 6,8 mm



71703-02
 8,5 mm



71703-03
 10 mm



71703-04
 11,5 mm



71703-05
 13 mm



71703-06
 14,5 mm

scharf/stumpf
 sharp/blunt
 cortante/roma
 tagliente/smussa



BLAKE
 71704-27
 27 cm, 10 1/2"

Salpingograph
 Salpingograph
 Salpingógrafa
 Salpingografo

71650-00

Schultze Salpingograph
 bestehend aus:

- 71650-01 1 Tubenkatheter
- 71650-02 1 Zwischenstück
- 71650-03 1 Manometer
- 71650-04 1 Kegel, klein
- 71650-05 1 Kegel, mittel
- 71650-06 1 Kegel, groß
- 71650-07 1 Recordspritze mit
Luer-Lock-Ansatz 10cc

Salpingógrafa compuesto de:

- 71650-01 1 cateter de tubo
- 71650-02 1 pieza de conexion
- 71650-03 1 manometro
- 71650-04 1 cono pequeño
- 71650-05 1 cono mediano
- 71650-06 1 cono grande
- 71650-07 1 jeringa con
conexion Luer-Lock 10cc

Salpingografo composto da:

- 71650-01 1 Catetere per tubo
- 71650-02 1 Raccordo
- 71650-03 1 Manometro
- 71650-04 1 Cono, piccolo
- 71650-05 1 Cono, medio
- 71650-06 1 Cono, grande
- 71650-07 1 Siringa record con
Raccordo Luer-Lock 10cc

71660-00

Schultze Salpingograph, jedoch ohne
 Manometer

Schultze Salpingograph without
 manometer

Schultze Salpingografo sin manometro

Schultze Salpingografo senza
 manometro

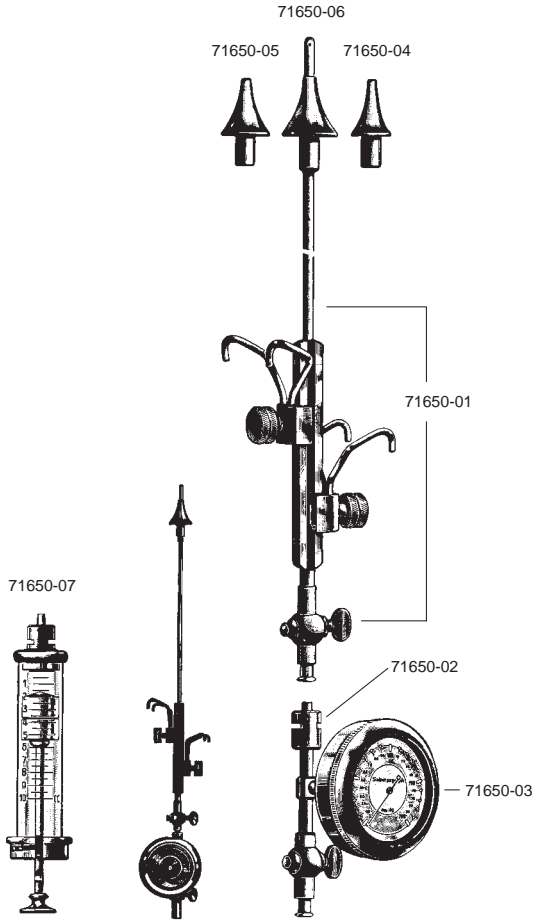

SCHULTZE
 71650-00
 compl.

im Etui
 in case
 en estuche
 in astuccio

Uterus-Küretten
 Uterine Curettes
 Curetas uterinas
 Curette Uterine



SIMS
 71710-05 - 71717-14
 28 cm, 11"

	scharf sharp cort. tagl.	Fig.	mm	stumpf blunt roma smussa
fest	71710-05	00	5,0	71715-05
rig.	71710-06	0	6,0	71715-06
	71710-07	1	7,5	71715-07
	71710-08	2	8,5	71715-08
	71710-09	3	10,0	71715-09
	71710-11	4	11,5	71715-11
	71710-12	5	13,5	71715-12
	71710-14	6	14,5	71715-14



RECAMIER
 71720-05 - 71727-20
 31 cm, 12 1/4"

	scharf sharp cort. tagl.	Fig.	mm	stumpf blunt roma smussa
fest	71720-05	00	5	71725-05
rig.	71720-06	0	6	71725-06
	71720-07	1	7	71725-07
	71720-08	2	8	71725-08
	71720-09	3	9	71725-09
	71720-11	4	11	71725-11
	71720-12	5	12	71725-12
	71720-14	6	14	71725-14
	71720-15	7	15	71725-15
	71720-16	8	16	71725-16
	71720-19	9	19	71725-19
	71720-20	10	20	71725-20



BUMM
 71730-30 - 71737-40
 28 cm, 11"

	scharf sharp cort. tagl.	Fig.	stumpf blunt roma smussa
fest	71730-30	14	71735-30
rig.	71730-35	15	71735-35
	71730-40	16	71735-40

	flexibel flexible fless.	Fig.	mm	71717-05
flexibel	71712-05	00	5,0	71717-05
flexible	71712-06	0	6,0	71717-06
fless.	71712-07	1	7,5	71717-07
	71712-08	2	8,5	71717-08
	71712-09	3	10,0	71717-09
	71712-11	4	11,5	71717-11
	71712-12	5	13,5	71717-12
	71712-14	6	14,5	71717-14

	flexibel flexible fless.	Fig.	mm	71727-05
flexibel	71722-05	00	5	71727-05
flexible	71722-06	0	6	71727-06
fless.	71722-07	1	7	71727-07
	71722-08	2	8	71727-08
	71722-09	3	9	71727-09
	71722-11	4	11	71727-11
	71722-12	5	12	71727-12
	71722-14	6	14	71727-14
	71722-15	7	15	71727-15
	71722-16	8	16	71727-16
	71722-19	9	19	71727-19
	71722-20	10	20	71727-20

	flexibel flexible fless.	Fig.	71737-30
flexibel	71732-30	14	71737-30
flexible	71732-35	15	71737-35
fless.	71732-40	16	71737-40

Uterus-Küretten
 Uterine Curettes
 Curetas uterinas
 Curette uterine

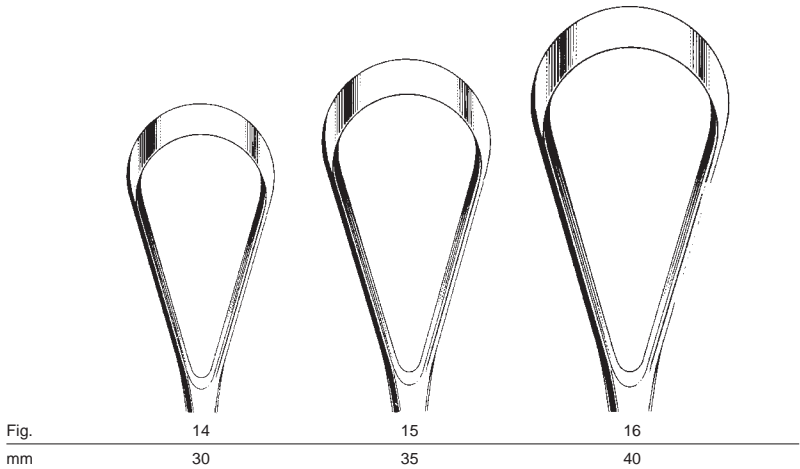
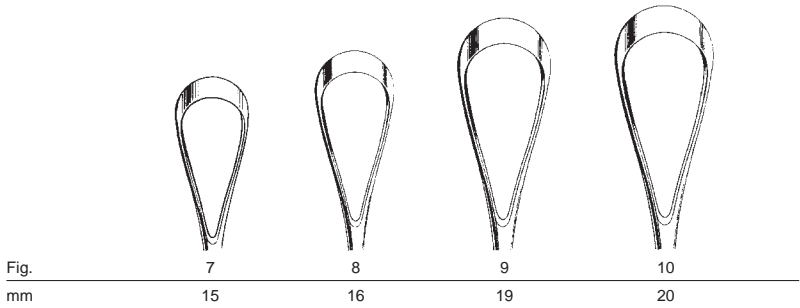
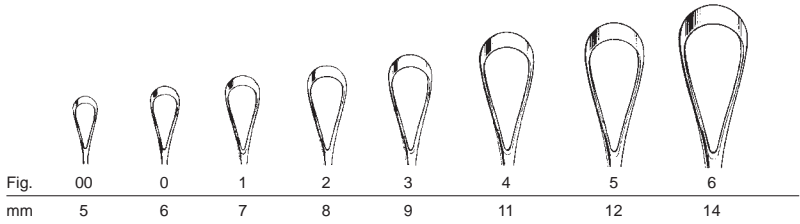

SIMS
 RECAMIER
 BUMM
 71710-05 - 71735-28

Uterus-Küretten
 Uterine Curettes
 Curetas uterinas
 Curette uterine



THOMAS
 28 cm, 11"

stumpf
 blunt
 roma
 smussa



Fig.0
 6 mm
 71736-00



Fig.1
 7 mm
 71736-07



Fig.2
 8 mm
 71736-08



Fig.3
 9 mm
 71736-09



Fig. 4
 10 mm
 71736-10

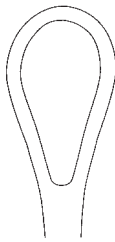

Fig. 5
 11 mm
 71736-11

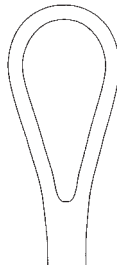

Fig. 6
 12 mm
 71736-12



GOURDET
 28 cm, 11"



6 mm
 71737-06



8 mm
 71737-08



10 mm
 71737-10



12 mm
 71737-12



14 mm
 71737-14

Biopsie- und Absaugküretten, Schlauch-Verbindungsstück
 Specimen and Aspirating Curettes, Hose connecting piece
 Curetas para biopsia y aspiración, Pieza conexión para tubos
 Curette di aspirazione per biopsia, Raccordo di connessione per tubi

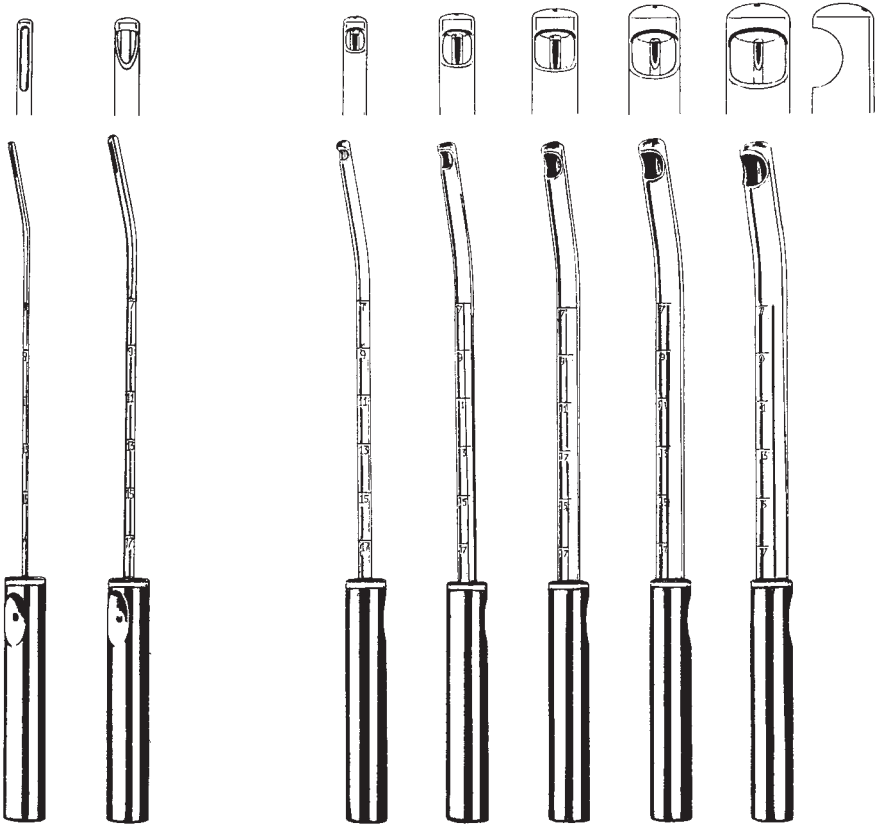

71803-03
3 mm Ø

71803-04
4,5 mm Ø

71803-06
6 mm Ø

71803-08
8 mm Ø

71803-10
10 mm Ø

71803-12
12 mm Ø

71803-14
14 mm Ø

71803-15

Amnioskope
Amnioscope
Amnioscopio
Amnioscopio



71810-12 12 x 24 mm Ø 20 cm (8") lang
71810-16 16 x 24 mm Ø 20 cm (8") lang
71810-20 20 x 24 mm Ø 20 cm (8") lang



71810-50
Kaltlichtklammer
Cold Light clamp
Adaptador de iluminacion
Adattore di illuminazione

Geburtszangen
 Obstetrical Forceps
 Forceps obstétricos
 Forcipi

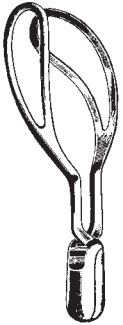

WRIGLEY
 73101-23
 23 cm, 9"



SIMPSON
 73102-30
 30 cm, 11 3/4"

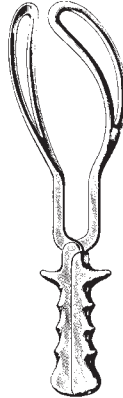

SIMPSON-BRAUN
 73105-33 33 cm, 13"
 73105-36 36 cm, 14"

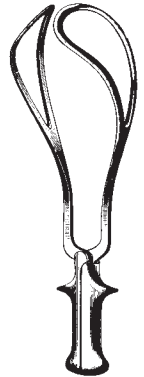

De LEE
 73107-30
 30 cm, 11 3/4"



De LEE
 73108-36 36 cm, 14"
 73108-39 39 cm, 15 1/2"

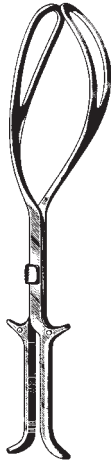

KIELLAND
 73110-41
 41 cm, 16"



ELLIOT
 73115-32 32 cm, 12 3/4"
 73115-38 38 cm, 15"

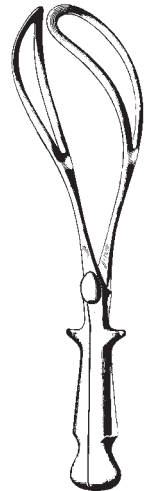

NAEGELE
 73119-36 36 cm, 14"
 73119-40 40 cm, 15 3/4"

Geburtszangen
 Obstetrical Forceps
 Forceps obstétricos
 Forcipi



LUIKART
 73125-40
 40 cm, 15 3/4"



KIELLAND-LUIKART
 73127-40
 40 cm, 15 3/4"

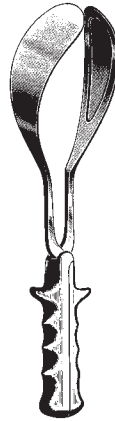

SIMPSON-LUIKART
 73135-36
 36 cm, 14"

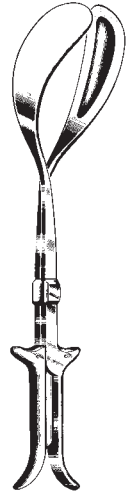

McLEAN-TUCKER-LUIKART
 73139-40
 40 cm, 15 3/4"



McLEAN-TUCKER
 73141-39
 39 cm, 15 1/2"



McLEAN-LUIKART
 73143-39
 39 cm, 15 1/2"



McLEAN
 73145-36
 36 cm, 14"

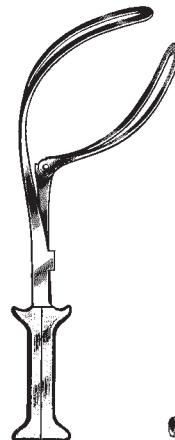

BARTON
 73147-36
 36 cm, 14"

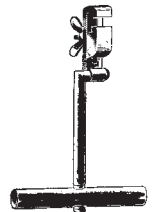

BARTON
 73148-17
 17 cm, 6 3/4"

Geburtszangen, Zughebel
 Obstetrical Forceps, Traction handles
 Forceps obstétricos, Dispositivos de tracción
 Forcipi, Leve per trazione

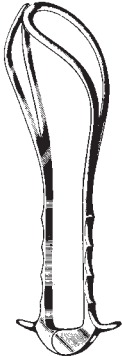

BOERMA
 73151-29
 29 cm, 11 1/2"

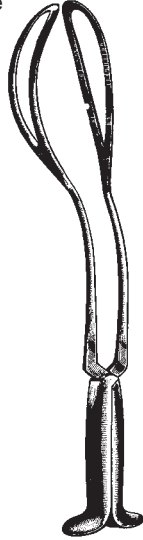

PIPER
 73155-44
 44 cm, 17 1/4"



PIPER
 73157-40
 40 cm, 15 3/4"

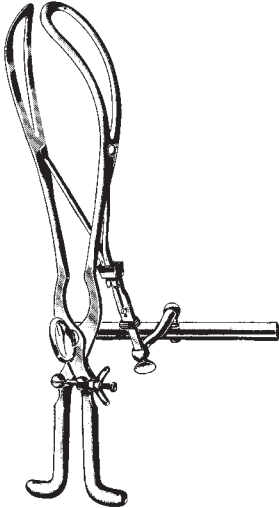

TARNIER
 73162-40
 40 cm, 15 3/4"

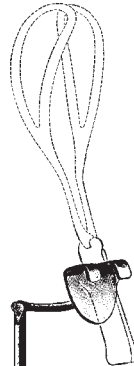

BILL
 73170-00
 21 cm, 8 1/4"

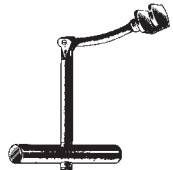

LIJKART-BILL
 73171-21
 21 cm, 8 1/4"

Haken, Kopfschwartenzangen, Uterus-Klemmzange, Nabelschnurklemmen, Beckenzirkel
 Scalp flap forceps, Uterine haemostatic forceps, Umbilical cord clamps, Pelvimeters
 Pinzas para cuero cabelludo, Pinzas-clamps uterinas para hemóstasis, Clamp umbilical, Pelvímetros
 Pinza per il cuoio capelluto, Pinza uterina, Pinza ombelicale, Pelvimetri



SMELLIE
73181-33
33 cm, 13"

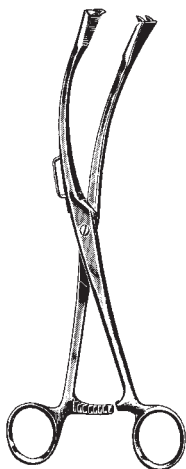

GAUSS
73183-27
27 cm, 10 1/2"



GREEN-ARMYTAGE
73184-21
21 cm, 8 1/4"



COLLIN
73187-09
9 cm, 3 1/2"

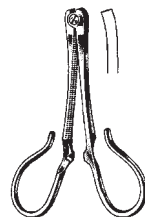

KANE
73189-09
8,5 cm, 3 1/4"

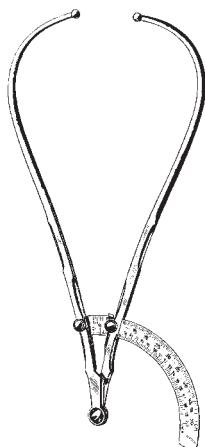

MARTIN
73191-34
34 cm, 13 1/2"

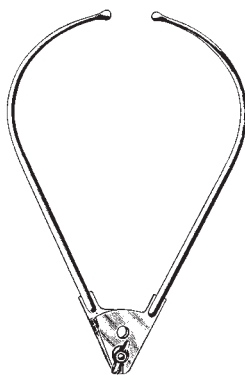

COLLIER
73193-30
30 cm, 11 3/4"

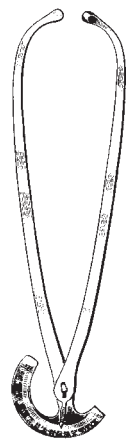

COLLIN
73195-35
35 cm, 14"

Abortuszangen, Abortuslöffel
 Ovum Forceps, Abortion Scoops
 Pinzas para aborto, Cucharillas para aborto
 Ostetricia, Curette per aborto

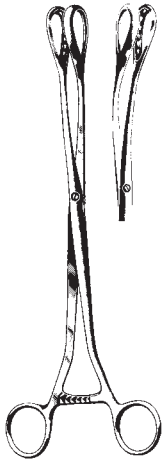

SAENGER
 73242-27 73243-27
 27 cm, 10 1/2"

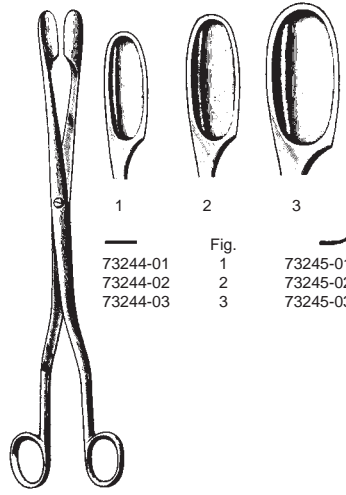

1	2	3
73244-01	73245-01	73245-01
73244-02	73245-02	73245-02
73244-03	73245-03	73245-03

WINTER
 73244-01 - 73245-03
 28 cm, 11"

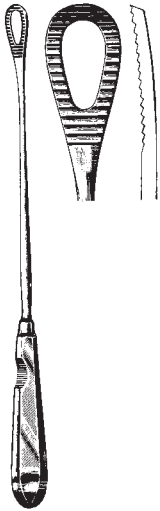

PESTALOZZA
 73252-30
 30 cm, 11 1/4"

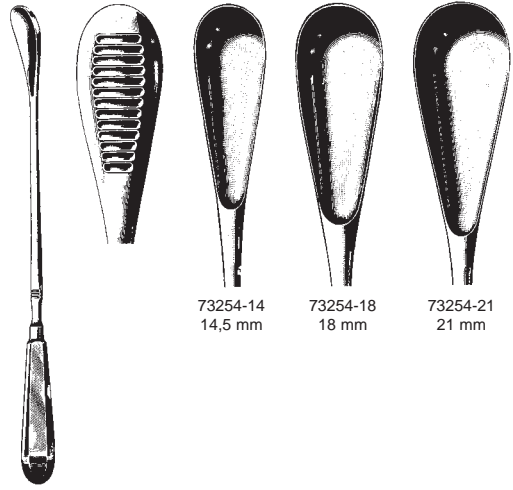

CUZZI
 73254-14 - 73254-21
 30 cm, 11 1/4"

Abortuslöffel, Geburtslöffel, Kranioklast, Basiotrip, Perforatorie, Dekapitationshaken
 Abortion Scoops, Elevating Spoon, Cranioclast, Basiotribe, Perforators, Decapitating hook
 Cucharillas para aborto, Separador obstetrico, Craneoclasto, Basiotribo, Perforacráneos, Gancho para decapitación
 Curette per aborto, Cucchiaino Ostetrico, cranioclasto, Basiotribo, spezzacrani, Uncino per decapitazione



stumpf
 blunt
 roma
 smussa



WALLICH
 73256-42
 42 cm, 16 1/2"



SELLHEIM
 73259-28
 28 cm, 11"

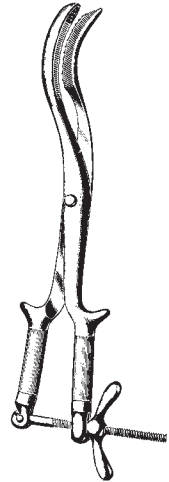

BRAUN
 73302-42
 42 cm, 16 1/2"



TARNIER
 73304-46
 46 cm, 18"

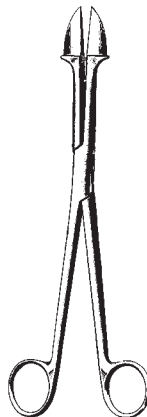

SMELLIE
 73306-25
 25 cm, 10"



BRAUN
 73309-30
 30 cm, 11 1/4"

Hauthäkchen, Komedonenquetscher, Lupusküretten, Hautküretten, Haut-Trephinen
 Skin hooks, Comedone extractors, Lupus curettes, Skin curettes, Cutaneous punches
 Ganchos cutáneos, Saca comedones, Curetas para lupus, Curetas cutáneas, Trépanos cutáneos
 Uncini cutanei, Schiaccia comedoni, Curette per lupus, Curette cutanee, Trefine cutanee



KILNER
75103-15
15 cm, 6"



SCHAMBERG
75111-10
10 cm, 4"



UNNA
75113-14
14 cm, 5 1/2"



UNNA
75115-14
14 cm, 5 1/2"



WALTON
75118-14
14 cm, 5 1/2"



SAALFELD
75121-10
10 cm, 4"

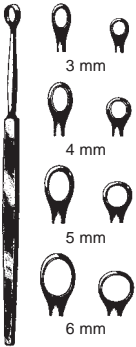

14 cm, 5 1/2"

FOX	FOX
75128-01 1 mm	75129-01 1 mm
75128-02 2 mm	75129-02 2 mm
75128-03 3 mm	75129-03 3 mm
75128-04 4 mm	75129-04 4 mm
75128-05 5 mm	75129-05 5 mm
75128-06 6 mm	75129-06 6 mm

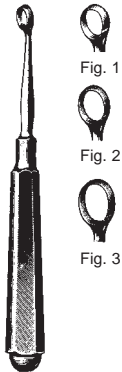

PIFFARD
14,5 cm, 5 3/4"
75130-01 Fig. 1
75130-02 Fig. 2
75130-03 Fig. 3

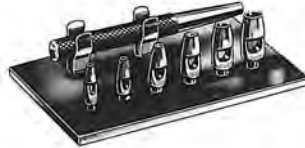

75138-00
Satz komplett mit 6 Aufsätzen
Set complete with 6 tips
Juego con 6 puntas
Serie completa con 6 trefini

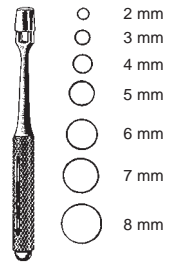

KEYES
10 cm, 4"
75140-02 2 mm
75140-03 3 mm
75140-04 4 mm
75140-05 5 mm
75140-06 6 mm
75140-07 7 mm
75140-08 8 mm

Nagelzangen, -Scheren
 Nail Nippers, Scissors
 Alicates corta-uñas
 Tronchesini forbici per unghie



75301-10

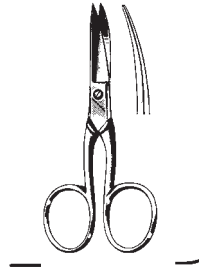

75304-10 10 cm, 4" 75305-10



75331-14
 14 cm, 5 1/2"
 stainless



TURNBULL
 75341-11 11,5 cm, 4 1/2"
 75341-13 13,5 cm, 5 1/4"
 stainless

Nagelhautzangen, Hautscheren, Nagelfeilen
 Cuticle Nippers, Cuticle Scissors, Nail Files
 Pinzas y Tijeras cuticulares, Limas para uñas
 Tronchesine per unghie e pelle, Limette per le unghie



75373-10
10,5 cm, 4"

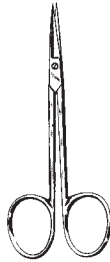

75378-10
10 cm, 4"

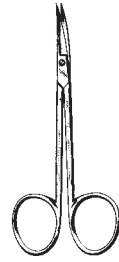

75379-10
10 cm, 4"



75382-16



75386-10 10 cm, 4"
75386-12 12 cm, 4 3/4"

Bürstenspender, Handwaschbürsten
 Brush Dispenser, Nail brushes
 Dispensador de cepillos, Cepillo para uñas
 Distributore di spazzole, Spazzole per unghie

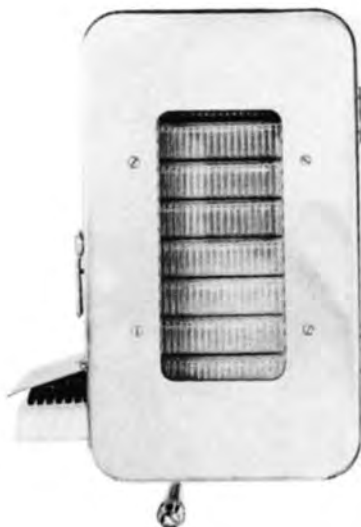

75396-01
 Bürstenspender für 10 Bürsten
 Brush dispenser for 10 brushes
 Distribuidor de cepillos para 10 cepillos
 Distributore per spazzolini da 10

75396-02
 Bürstenspender für 20 Bürsten
 Brush dispenser for 20 brushes
 Distribuidor de cepillos para 20 cepillos
 Distributore per spazzolini da 20

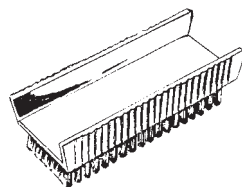

75397-00

Pack. à 10 St.
 Box of 10 pcs.
 caja de 10 pzas.
 confezione da 10 pezzi

Hygiene
Hygiene
Higiene
Igiene



PROBE AND PACKER
75450-00
14,5 cm, 5 3/4"



SPATULA AND PACKER
75440-00
14,5 cm, 5 3/4"



mit Loch, with hole,
con agujero, con foro
75430-12 = 1,5 mm + 2 mm
75430-13 = 1,5 mm + 2,5 mm
14,5 cm, 5 3/4"



14,5 cm, 5 3/4"
ohne Loch, without hole,
sin agujero, senza foro

75400-01 = 1 mm
75400-02 = 1,5 mm
75400-03 = 2 mm
75400-04 = 2,5 mm

mit Loch, with hole,
con agujero, con foro

75410-01 = 1 mm
75410-02 = 1,5 mm
75410-03 = 2 mm
75410-04 = 2,5 mm

Hygiene
Hygiene
Higiene
Igiene

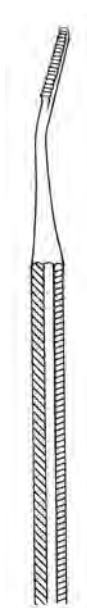

75420-15
15 cm, 6"

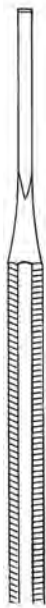

75430-01
12,5 cm, 5"

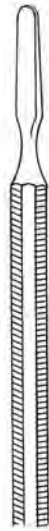

75440-11
11,5 cm, 4 1/2"

Nagelzangen
 Nail Nippers
 Alicates corta-uñas
 Tronchesini per unghie

stainless steel



75450-13
 concave

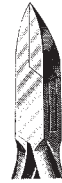

75460-13
 gerade
 straight
 recto
 retta

75450-13 - 75460-13
 13 cm, 5 1/8"

stainless steel



75470-11
 10 cm
 4"



75475-11
 11,5 cm
 4 1/2"



75480-13
 12,5 cm
 5"



fine
 75485-13
 12,5 cm
 5"



75490-15
 15 cm
 6"

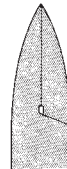

fine
 75500-15
 15 cm
 6"

Nagelzangen
Nail Nippers
Alicates corta-uñas
Tronchesini per unghie

stainless steel

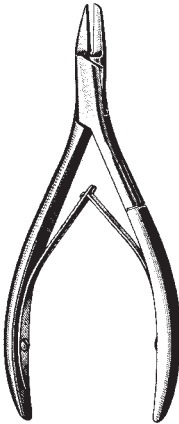

ANVIL
75550-13
13 cm, 5 1/8"

stainless steel

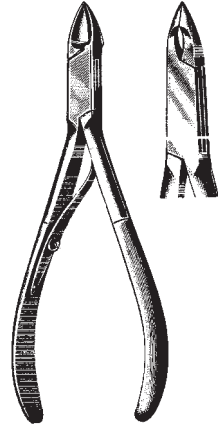

75600-10
10 cm, 4"

stainless steel



75618-15
15,2 cm, 6"

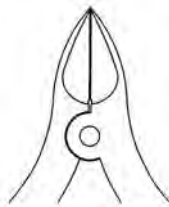

gerade
straight

stainless steel

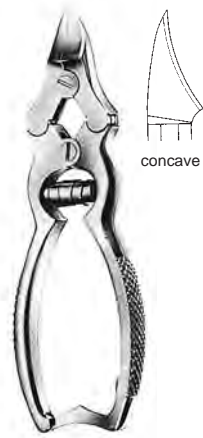

75620-15
15,5 cm, 6"



concave

Nagelzangen, Nagelscheren
 Nail Nippers, Nail scissors
 Alicates corta-uñas, Tijeras para uñas
 Tronchesini per unghie, Forbici per unghie



75630-12
 12 cm, 4³/₄"



75640-15
 15 cm, 6"

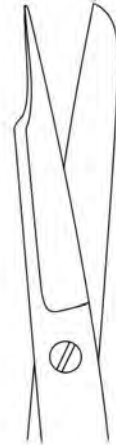

Nagelspaltscheren
 Nail splitting scissors
 Tijeras para hender uñas
 Forbici per staccare unghie

Nadel-Sterilisierkästen, Kappenzangen
 Needle Sterilizing cases, Sterilizing Forceps
 Estuches para esterilizar agujas, Combinacion tapa-pinza
 Scatole per sterilizzare aghi, Pinza coperchio

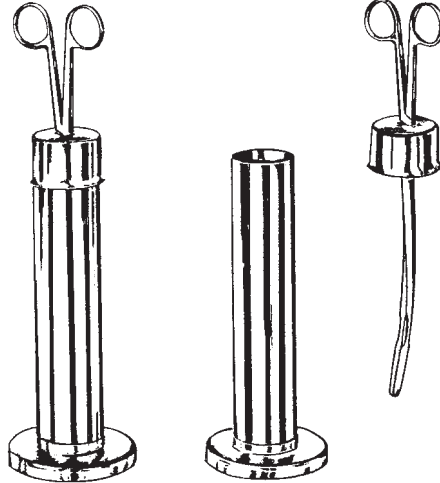

89111-25 25 cm, 10"
 89111-32 32 cm, 12 1/4"



89112-65
 65 x 15 mm



89113-65



89114-00
 150 x 95 x 13 mm



89115-50 50 x 25 x 4,5 mm
 89115-65 65 x 42 x 8,0 mm
 89115-75 75 x 25 x 4,5 mm



89116-50 50 x 25 x 4,5 mm
 89116-65 65 x 42 x 8,0 mm
 89116-75 75 x 25 x 4,5 mm

Sterilisierkästen
 Sterilizing Cases
 Cajas para esterilización
 Scatole per sterilizzazione



89117-20 200 x 100 x 25 mm
 89117-23 230 x 130 x 25 mm
 89117-27 275 x 230 x 25 mm

Sterilisier-Behälter mit Silikonmatte
 Micro instrument tray with silicone mat
 Caja para instrumental micro-quirurgico con alfombrilla de silicona
 Scatola per sterilizzazione con stuola in silicone

89118-20
 89118-23
 89118-27

Silikonmatte
 Silicone mat
 Alfombrilla de silicona
 Stuola in silicone

Instrumentenkästen
Instrument Boxes
Cajas para instrumentos
Scatole per strumenti

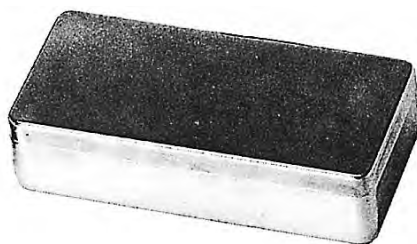

Abmessungen in mm	ohne Knopfdeckel
Sizes in mm	lid without knob
tamaños en mm	tapa sin botón
misura in mm	coperchio senza bottone

I x b x h mm	
165x 85x35	89122-16
200x100x50	89122-21
260x150x50	89122-26
310x200x50	89122-30

Sterilisierkästen
 Sterilizing Cases
 Cajas para esterilización
 Scatole per sterilizzazione



Abmessungen in mm (l x b x h)
 Sizes in mm (l x b x h)
 tamaños en mm (l x f x a)
 misura in mm (l x l x a)

230 x 130 x 50
 260 x 150 x 50
 275 x 235 x 50
 300 x 200 x 50
 325 x 275 x 50
 420 x 175 x 50

230 x 130 x 75
 260 x 150 x 75
 300 x 200 x 75
 325 x 275 x 75
 420 x 175 x 75

Behälter
 Containers
 Recipientes
 Recipienti

89124-23
 89124-26
 89124-27
 89124-30
 89124-32
 89124-42

89125-23
 89125-26
 89125-30
 89125-32
 89125-42

Satz Spezialfilter (5 Paar)
 Set of special filters (5 pairs)
 Juego de filtros especiales (5 pares)
 Set die 5 paia di filtri speciali

89126-23
 89126-26
 89126-27
 89126-30
 89126-32
 89126-42

89127-23
 89127-26
 89127-30
 89127-32
 89127-42

Schalen
Trays
Bandejas
Bacinelle

18/10
Stainless Steel
Acero inoxidable
Acciaio inossidabile

matt
satin finish
pulidas mate
opaco



Abmessungen in mm sizes in mm Tamaños en mm misura in mm Ø x h	Inhalt capacity capacidad capacità l	
40x19	0,05	89127-04
61x30	0,07	89127-06
80x40	0,14	89127-08
116x50	0,35	89127-11
128x55	0,45	89127-12
147x65	0,70	89127-14
167x75	1,10	89127-16
187x85	1,60	89127-18



Abmessungen in mm sizes in mm Tamaños en mm misura in mm Ø x h	Inhalt capacity capacidad capacità l	
110x28	0,15	89129-11



	mm x mm	l
89133-16	165 x 60	0,75
89133-17	175 x 70	1,00
89133-22	220 x 80	2,00
89133-24	240 x 110	3,00
89133-25	255 x 115	4,00
89133-31	310 x 120	6,00
89133-34	345 x 125	8,50
89133-38	380 x 130	11,00



89139-17	170 x 100 x 35 mm	0,50 l
89139-25	250 x 140 x 40 mm	1,25 l
89139-27	275 x 150 x 45 mm	2,25 l

Meßbecher, Dose, Standgefäß, Mehrzweckschalen
 Graduated Measures, Box, Jars, Universal Trays
 Copas graduadas, Recipientes, Tarros, Bandejas para instrumentos
 Bicchieri graduati, Recipienti, Recipienti cilindrici, Bacinelle per strumenti



l	
0,25	89140-02
0,5	89140-05
1,0	89140-10
2,0	89140-20



89141-10
100 x 20 mm

18/10
Stainless Steel
Acero inoxidable
Acciaio inossidabile

matt
satin finish
pulidas mate
opaco



	mmxmm
89142-01	30x 90
89142-02	50x100
89142-03	50x130
89142-04	50x175
89142-05	75x100
89142-06	75x130
89142-07	75x175



89147-21 - 89147-42

	l x b x h
89147-21	210x160x10 mm
89147-24	240x180x10 mm
89147-30	310x150x10 mm
89147-31	310x210x10 mm
89147-35	350x240x10 mm
89147-40	400x270x20 mm
89147-42	420x280x10 mm



89145-23 - 89145-40

	l x b x h
89145-23	230x155x30 mm
89145-30	300x175x30 mm
89145-31	300x175x40 mm
89145-35	350x240x36 mm

Medizinlöffel, -becher, Tablettenschale, Sputumbecher, Stechbecken, Plazentabecken
 Medicine Spoon and Cups, Trays for tablets, Sputum Cup, Bed Pan, Placenta Pan
 Cuchara graduada, Vasos graduados, Platos para tabletas, Escupidera, Silleta, Cubeta para placenta
 Cucchiaino per medicinali, bicchieri per medicinali, Bacinelle per compresse, Sputacchiera, Padella, bacinella per placenta



89146-20 20 cc
110 x 20 mm



89147-10 100 cc
89147-25 250 cc



89148-25 25 cc
89148-50 50 cc



89148-31
ø 310 mm



89148-32



89148-35
350 x 290 x 90 mm



89149-13 110 x 13 mm
89149-20 95 x 20 mm



89150-30
90 x 80 mm

Verbandstofftrommel, Sterilisiersiebschalen
 Sterilizing Drums, Sterilization Trays
 Tambores p. esterilización, Cestas de esterilización
 Tamburi p. sterilizzazione, Cestelli per sterilizzazione



SCHIMMELBUSCH

	Ø	mmxmm
89152-08	125x	80
89152-10	125x	100
89152-12	125x	125
89155-08	150x	80
89155-10	150x	100
89155-13	150x	130
89155-15	150x	150
89155-19	150x	190
89159-14	190x	145
89159-16	190x	165
89159-19	190x	190
89159-24	190x	240
89164-14	240x	145
89164-16	240x	165
89164-19	240x	190
89164-24	240x	240
89164-29	240x	290
89164-34	240x	340
89164-39	240x	390
89169-14	290x	145
89169-16	290x	165
89169-19	290x	190
89169-24	290x	240
89169-29	290x	290
89169-34	290x	340
89169-39	290x	390
89174-14	340x	145
89174-16	340x	165
89174-19	340x	190
89174-24	340x	240
89174-29	340x	290
89174-34	340x	340
89174-39	340x	390
89179-14	390x	145
89179-16	390x	165
89179-19	390x	190
89179-24	390x	240
89179-29	390x	290
89179-34	390x	340
89179-39	390x	390
89179-49	390x	490
89179-59	390x	590

18/10

Stainless Steel
 Acero inoxidable
 Acciaio inossidabile
 Acciaio inossidabile

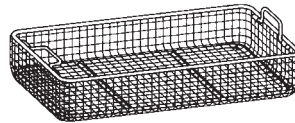

R390.03 255x245x 30 mm
 R390.05 255x245x 50 mm
 R390.07 255x245x 70 mm
 R390.10 255x245x100 mm

R190.03 485x255x 30 mm
 R190.05 485x255x 50 mm
 R190.07 485x255x 70 mm
 R190.10 485x255x100 mm

R191.03 540x255x 30 mm
 R191.05 540x255x 50 mm
 R191.07 540x255x 70 mm
 R191.10 540x255x100 mm

Siebschalen, Endoskopiekorb
Trays
Bandejas
Cestelli

Aus perforiertem Blech
From Perforated Sheet Metal
De chapa de acero perforada
In acciaio perforato

18/10
Stainless Steel
Acero inoxidable
Acciaio inossidabile



	cmxcmxcm
89250-10	24x24x 5
89250-20	24x24x 8
89250-30	24x24x10
89250-40	48x26x 5
89250-50	52x26x 8
89250-60	52x26x10

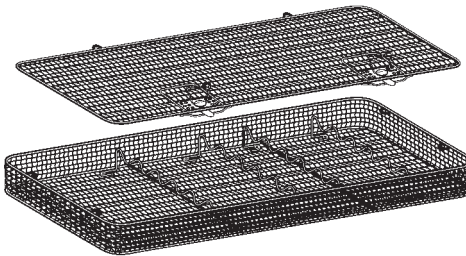

für Lichtleiterkabel
for cold light cables
para cables de luz fría
per cavi a fibre/ottiche
89255-60 420x250x60 mm

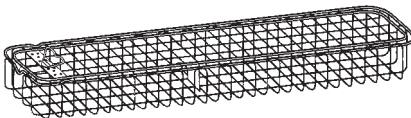

für 1 Endoskop, for 1 endoscope,
para 1 endoscopio, per 1 endoscopio
89256-29 290x80x52 mm
89256-46 460x80x52 mm
89256-67 670x80x52 mm

für 2 Endoskope, for 2 endoscopes,
para 2 endoscopios, per 2 endoscopi rigidi
89257-46 460x80x52 mm

Schlauchklemmen, Messgerät, Sterilisierklammern
 Tubing Clamp, Decimal spring caliper, Safety pins
 Pinzas para tubos, calibrador decimal, Cadres de estérilización
 Morsetti serratubi, compasso, pinze per sterilizzazione

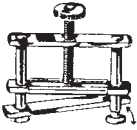

HOFFMANN
 89260-13 13 mm
 89260-17 17 mm
 89260-20 20 mm
 89260-25 25 mm
 89260-30 30 mm
 89260-40 40 mm

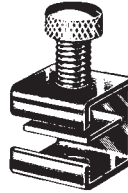

SIMPLEX
 89265-12

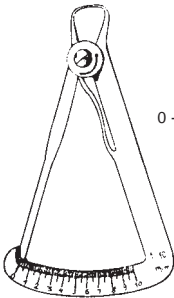

0 - 10 mm

IWANSON
 89270-15



BUNT
 29150-12
 12 cm, 4 3/4"



MAYO
 29152-14
 14 cm, 5 1/2"

Reinigungspistole
Water Jet Pistol
Pistola-lavatora
Pistola lavatrice



89500-00
komplett mit 9 Aufsätzen
complete with 9 tips
con 9 toberas
completa con 9 raccordi

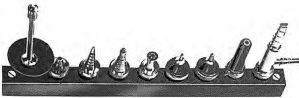

89500-01
Reinigungsaufsatz für Flaschen
Cleansing Tip for bottles
Tobera para botellas
Raccordo di lavaggio per bottiglie



89500-02
Reinigungsaufsatz für Recordspritzen-Konen
Cleansing Tip for Cones of Record Syringes
Tobera para conos de jeringas Record
Raccordo per coni di siringhe Record



89500-03
Reinigungsaufsatz für Katheter
Cleansing Tip for Catheters
Tobera para catéteres
Raccordo di lavaggio per cateteri



89500-04
Reinigungsaufsatz für Drainageschläuche
Cleansing Tip for Drainage Tubings
Tobera para tubos de drenaje
Raccordo di lavaggio per tubi di drenaggio



89500-05
Reinigungsaufsatz für Hohlgefäße (Brause)
Cleansing Tip for Receptacles (Shower)
Tobera para recipientes (ducha)
Raccordo di lavaggio per recipienti (doccia)

89500-12
Pistole allein
Pistol only
Pistola sola
Pistola sola

89500-06
Reinigungsaufsatz für Kanülen mit Recordkonus
Cleansing Tip for hypodermic needles with Record Cone
Tobera para agujas de inyección con cono Record
Raccordo di lavaggio per aghi ipodermici con cono Record



89500-07
Reinigungsaufsatz für Kanülen mit Luerkonus
Cleansing Tip for hypodermic needles with Luer Cone
Tobera para agujas de inyección con cono Luer
Raccordo di lavaggio per aghi ipodermici con cono Luer



89500-08
Reinigungsaufsatz für Meß- und Vollpipetten
Cleansing Tip for Meas. and Volumetric Pipettes
Tobera para pipetas de medida y volumétricas
Raccordo di lavaggio per pipette comuni e graduate



89500-09
Reinigungsaufsatz für feine Pipetten
Cleansing Tip for fine pipettes
Tobera para pipetas finas
Raccordo di lavaggio per pipette fine



89500-10
Reinigungsaufsatz 31 cm (12 1/4") gerade
Cleansing Tip 31 cm (12 1/4") straight
Tobera 31 cm (12 1/4") recta
Raccordo 31 cm (12 1/4") retto



89500-11
Reinigungsaufsatz 30 cm (11 3/4") aufgebogen
Cleansing Tip 30 cm (11 3/4") curved
Tobera 30 cm (11 3/4") curva
Raccordo di lavaggio 30 cm (11 3/4") curvo

89501-03
Überwurfmutter zum Anschluß an Gewindehähne
Couplings for connection to water tap
Tuercas-hembras para conexión al grifo de agua
Dadi premistoppa per connessione ai rubinetti filettati

Hochfrequenz-Chirurgie
 High Frequency Surgery
 Electrocirugía
 Electrochirurgia

Mindestbestellmenge 10
 Minimum order quantity 10
 Cantidad mínima 10
 Minimo di quantitativo 10



91010-01
 Fig. 1



91010-02
 Fig. 2 45°



91010-03
 Fig. 3 120°



91010-11
 Fig. 11
 Ø 3 mm



91010-12
 Fig. 12
 Ø 5 mm



91010-13
 Fig. 13
 Ø 8 mm



91010-14
 Fig. 14



91010-15
 Fig. 15 45°
 7,0x1,5 mm



91010-16
 Fig. 16 45°
 7 mm



91010-17
 Fig. 17
 6,0x1,3 mm



91010-18
 Fig. 18 30°
 7,0x1,7 mm



91010-21
 Fig. 21
 7,0x1,7 mm



91010-31
 Fig. 31 45°
 Ø 0,6 mm



91010-33
 Fig. 33 45°
 Ø 1,7 mm



91010-34
 Fig. 34 45°
 Ø 3,0 mm



91010-35
 Fig. 35



91010-36
 Fig. 36 90°

Schaft
 shaft
 vástago
 asta
 Ø 2,4 mm

Hochfrequenz-Chirurgie
High Frequency Surgery
Electrochirurgia
Elettrochirurgia

Mindestbestellmenge 10
Minimum order quantity 10
Cantidad minima 10
Minimo di quantitativo 10



91011-51
Fig. 51 45°
Ø 3 mm



91011-52
Fig. 52 45°
7,0x1,7 mm



91011-53
Fig. 53 45°



91011-54
Fig. 54



91011-55
Fig. 55



91011-56
Fig. 56 45°
Ø 5 mm



91011-61
Fig. 61 45°



91011-62
Fig. 62 90°

Schaft
shaft
vástago
ast
Ø 2,4 mm

Serie STANDARD



91020-01



91020-02

Schaft
shaft
vástago
asta
Ø 4 mm



91020-03



91020-04



Ø mm
5 91022-05
10 91022-10
20 91022-20



Ø mm
10 91024-10
15 91024-15
20 91024-20



Ø mm
2 91030-02
4 91030-04
6 91030-06

Schaft
shaft
vástago
asta
Ø 4 mm

Bipolare Koagulation
 Bipolar Coagulation
 Coagulación bipolar
 Coagulazione bipolare



91102-11
 11 cm, 4 3/8"



91104-11
 11 cm, 4 3/8"



91109-11
 11 cm, 4 3/8"
 45°



91113-11
 11 cm, 4 3/8"
 45°



91115-11
 11 cm, 4 3/8"
 45°



91122-16
 16,5 cm, 6 1/2"



91123-16
 16,5 cm, 6 1/2"



91124-16
 16,5 cm, 6 1/2"
 1 mm



91125-16
 16,5 cm, 6 1/2"



91127-16
 16,5 cm, 6 1/2"
 1 mm

Bipolare Koagulation
 Bipolar Coagulation
 Coagulación bipolar
 Coagulazione bipolare



91142-16
 16,5 cm, 6 1/2"



91144-16
 16,5 cm, 6 1/2"



91146-16
 16,5 cm, 6 1/2"
 1 mm



91152-19
 19,5 cm, 7 3/4"



91154-19
 19,5 cm, 7 3/4"
 1 mm



91157-19
 19,5 cm, 7 3/4"
 1 mm



91159-19
 19,5 cm, 7 3/4"
 2 mm

Bipolare Koagulation
 Bipolar Coagulation
 Coagulación bipolar
 Coagulazione bipolare



91162-19
 19,5 cm, 7 3/4"
 2 mm



91164-19
 19,5 cm, 7 3/4"
 1 mm



91166-19
 19,5 cm, 7 3/4"
 2 mm



91167-19
 19,5 cm, 7 3/4"
 1 mm



91169-19
 19,5 cm, 7 3/4"
 1 mm



91172-03 - 91172-12
 22,5 cm, 8.9"



91172-03
 0,3 mm



91172-07
 0,7 mm



91172-12
 1,2 mm

Bipolare Koagulation
 Bipolar Coagulation
 Coagulación bipolar
 Coagulazione bipolare

Verbindungskabel
 Connection Cords
 Cables de conexión
 Cavi da connessione



		ERBE SELECT	AESCLAP	USA Mod.	MARTIN
3 m	118"	91190-30	91191-30	91192-30	91193-30
5 m	197"	91190-50		91192-50	91193-50

für Elektro-Chirurgie-Einheiten
 for Electrosurgery Equipment
 para Electrobisturías
 per Elettrobisturi

**Index
Indice
Index
Verzeichnis**

ABDOMINAL- A. BOWEL SPATULA KÜMMEL.....	143/2, 144	ANAL RETRACTOR SMITH-BUIE.....	561	ATRAUMATIC TISSUE FORCEPS DEBAKEY.....	99
ABDOMINAL RETRACTORS KIRSCHNER.....	187, 187/1	ANASTKL. DE MARTEL-WOLFSON.....	546	AUFRANC RETRACTOR.....	289
ABDOMINAL RETRACTORS BABY GOSSET.....	181	ANASTOMOSIS CLAMP BECK.....	516	AUFREIBER KJENTSCHER.....	321
ABDOMINAL RETRACTORS BALFOUR.....	182	ANASTOMOSIS CLAMP BECK.....	520	AUFRICHT NOSE HOOK.....	447
ABDOMINAL RETRACTORS BALFOUR BABY.....	182	ANASTOMOSIS CLAMP COOLEY.....	519, 520	AUFRICHT NOSE RASP.....	443
ABDOMINAL RETRACTORS BALFOUR-US.....	184	ANASTOMOSIS CLAMP COOLEY-DERRA.....	519	AURIKELCLAMP HARKEN.....	503
ABDOMINAL RETRACTORS CHARNELY.....	289	ANASTOMOSIS CLAMP DEBAKEY.....	505	AUTOPSY KNIVES.....	48
ABDOMINAL RETRACTORS COLLIN.....	190	ANASTOMOSIS CLAMP LAMBERT-KAY.....	505	AUTOPSY SAW.....	231/1
ABDOMINAL RETRACTORS COLLIN-LOKTTIE.....	191	ANATOMIC TISSUE FORCEPS BROPHY.....	84	AUVARD VAGINAL SPECULA.....	576
ABDOMINAL RETRACTORS DENIS-BROWNE.....	186	ANATOMIC TISSUE FORCEPS.....	81/2	AWL.....	304
ABDOMINAL RETRACTORS DOYEN.....	189/1	ANATOMIC TISSUE FORCEPS ADSON.....	81/2	AWL HARGIS.....	463
ABDOMINAL RETRACTORS FRAZIER.....	181	ANATOMIC TISSUE FORCEPS ADSON MICRO.....	81/2	AWL PERTHES.....	304
ABDOMINAL RETRACTORS GELPI.....	189/1, 189/2	ANATOMIC TISSUE FORCEPS BONNEY.....	88	AXENFELD CHALAZIO CURETTE.....	377
ABDOMINAL RETRACTORS GOSSET.....	181	ANATOMIC TISSUE FORCEPS CUSHING.....	83	AYER CHALAZIO TISSUE FORCEPS.....	393
ABDOMINAL RETRACTORS KIRSCHNER.....	185, 187	ANATOMIC TISSUE FORCEPS CUSHING-TAYLOR.....	87		
ABDOMINAL RETRACTORS RICARD.....	191	ANATOMIC TISSUE FORCEPS DUEHRSEN.....	84	B	
ABDOMINAL RETRACTORS RIGBY.....	189/2	ANATOMIC TISSUE FORCEPS GERALD.....	86	BABCOCK BOWEL GRASPING FORCEPS.....	539
ABDOMINAL RETRACTORS ROCHARD.....	186	ANATOMIC TISSUE FORCEPS MCINDOE.....	85	BABINSKI PERCUSSION HAMMER.....	24
ABDOMINAL SPATULA KADER.....	143/1	ANATOMIC TISSUE FORCEPS POTTS-SMITH.....	81	BABY BURKE BIOPSY FORCEPS.....	590
ABDOMINAL SPATULA LERICHE.....	143/2	ANATOMIC TISSUE FORCEPS SEMKEN.....	86	BABY GOSSET ABDOMINALRETRACTORS.....	181
ABLI OPHTHALMOLOGIC SCISSORS.....	58	ANATOMIC TISSUE FORCEPS TAYLOR.....	87	BABY MITCHENBAUM SUPERCUT SCISSORS.....	71
ABRAHAM TONSIL FORCEP.....	466	ANATOMIC TISSUE FORCEPS TC.....	81	BABY TISCHLER RONGEUR.....	592
ABRAHAM TONSIL KNIVES.....	466	ANATOMIC TISSUE FORCEPS TYPE USA.....	81	BABY WEBSTER NEEDLE HOLDER.....	208
ACCESSORIES FOR AUTOPY SAW.....	231/3	ANATOMIC TISSUE FORCEPSSTILLE.....	81	BABY YANKAUER SUCTION TUBE.....	27
ADENOID CURETTE BARNHILL.....	450	ANDERSON ADSON RETRACTORS.....	172	BABY-KOCHER BOWEL CLAMP.....	540
ADENOID CURETTE BECKMANN.....	450	ANDERSON RETRACTOR.....	198	BABY-OLSEN-HEGAR NEEDLE HOLDER.....	212
ADENOID CURETTEST. CLAIR-THOMSON.....	450	ANDREW TONGUE DEPRESSOR.....	452	BABYPHON SPHYGMOANOMETER.....	10
ADENOTOM LA FORCE.....	450	ANDREW-PYNCHON SUCTION TUBE.....	28	BACK HOLDER ABDOMINAL RETRACTOR SYSTEM.....	192, 193, 194, 195
ADLERKREUTZ VASCULARTISSUE FORCEPCS.....	84	ANESTOPHON.....	23	BACKHAUS TOWEL CLAMP.....	132
ADSON RETRACTORS.....	173	ANEURYSM CLAMP DEBAKEY-BAHNSON.....	506	BACKHAUS-CLIP.....	132
ADSON ANATOMIC TISSUE FORCEPS.....	81/2	ANEURYSM CLIPS APPLIER FORCEPS.....	357, 358, 359, 360	BAILEY RIB SPREADER.....	489
ADSON ANATOMIC TISSUE FORCEPS.....	81/2	ANEURYSM VASCULAR CLIP YASARGIL.....	349, 350, 351, 352, 353, 354, 355, 356	BAILEY-BABY RIB SPREADER.....	489
ADSON BABY HEMOSTATIC CLAMP.....	113	ANOSCOPE HIRSCHMANN.....	562	BAILEY-GIBBON RIB SPREADER.....	489
ADSON BONE RONGEUR.....	236	ANOSCOPE IVES-FANSLER.....	562	BAINBRIDGE HEMOSTATIC CLAMP.....	120
ADSON DURAHOOK.....	328	ANTRUM CURETTE COAKLEY.....	449	BAINBRIDGE VASCULAR CLAMP.....	495
ADSON HEMOSTATIC CLAMP.....	112	ANTRUM RASP GALLAHER.....	446	BAKES GALL DUCT DILATOR.....	532
ADSON HOLDING CLAMP.....	298	ANTRUM RASP LEWIS.....	443	BALFOUR ABDOMINALRETRACTORS.....	182
ADSON HYPOPHYSE-TISSUE FORCEPS.....	334	ANTRUM-CURETTE.....	435	BALFOUR BABY ABDOMINALRETRACTORS.....	182
ADSON MICRO ANATOMIC TISSUE FORCEPS.....	81/2	ANVIL NAISPALTFORCEPS.....	613	BALFOUR HOOK.....	193
ADSON MICRO SURGICAL TISSUE FORCEPS.....	81/2	AORTIC DILATOR COOLEY.....	528	BALFOUR-US ABDOMINALRETRACTORS.....	184
ADSON NEEDLE HOLDER.....	211	AORTIC-DILATOR TUBBS.....	528	BALL AND SOCKET TOWEL CLAMP.....	133
ADSON RASPATORIES.....	282	APPENDIXBOWEL CLAMP ALLEN.....	544	BALL ELECTRODE MONOPOLAR.....	628, 629
ADSON RETRACTORS.....	172, 173, 174	APPENDIXBOWEL CLAMP KLEINSCHMIDT.....	544	BALLENGER SCHWINGKNIVES.....	436
ADSON SUCTION TUBE.....	337	APPLIER FORCEPS ANEURISMEN CLIPS.....	357, 358, 359, 360	BALLENGER SEPTUM ELEVATOR.....	439
ADSON SURGICAL TISSUE FORCEPS.....	81/2	APPLIER FORCEPS BIEMER.....	361, 366	BALLENGER TONSIL FORCEPS.....	467
ADSON-BROWN SURGICAL TISSUE FORCEPS.....	82	APPLIER FORCEPS MEHDORN.....	362	BANDAGE CUFF.....	295
ADSON-DEBAKEY ATRAUMATIC FORCEPS.....	81/2	APPLIERFORCEPS JOHNS-HOPKINS.....	104	BANDAGE DRUMSSCHIMMELBUSCH.....	622
AHLE OBWEGESER.....	463	APPLIERFORCEPS MC KENZIE.....	326	BANDAGE SCISSORS.....	70
AIR BLOWER.....	405	APPLIERFORCEPS SMITHWICK.....	326	BANDAGE SCISSORS BERGMANN.....	69/1
AIR BLOWER POLITZER.....	406	APPLIERFORCEPS SWEET.....	326	BANDAGE SCISSORS BRUNS.....	70
AIR INJECTION EYE CANNULA.....	394	APPLING FORCEPS RANEY.....	327	BANDAGE SCISSORS ESMARCH.....	69/2
AIR PUMP.....	295	APPROXIMATOR BIEMER.....	366	BANDAGE SCISSORS KNOWLES.....	70
ALAN-PARKS RECTAL-SPECULA.....	561	APPROXIMATOR BIEMER-MÜLLER.....	363	BANDAGE SCISSORS LISTER.....	69/1
ALDERDYCE ELEVATOR.....	282	APPROXIMATOR MÜLLER.....	364	BANDAGE SCISSORS LORENZ.....	70
ALEXANDER BIOPSY FORCEPS.....	589	ARCHER SPLINTERFORCEPS.....	92	BANDAGE SCISSORS REDA EXCENTER.....	69/2
ALEXANDER CHISELS.....	259	ARL CATARACT LOOP.....	378	BANDAGE SCISSORS SEUTIN.....	69/2
ALEXANDER RASPATORIES.....	276	ARMSYSTEM.....	188	BANDAGE SCISSORS SMITH US ARMY.....	69/2
ALLEN APPENDIX BOWEL CLAMP.....	544	ARRUGA CAPSULAR FORCEPS.....	391	BANDAGE SCISSORS UNIVERSAL.....	70
ALLIS BOWEL GRASPING FORCEPS.....	537	ARRUGA EXTRAKTION HOOK.....	375	BANE-HARTMANN BONE RONGEUR.....	237
ALLIS-ADAIR BOWEL GRASPING FORCEPS.....	537	ARRUGA EYE SPECULA.....	370	BANGERTER CYCLODIALYSIS SPATULA.....	379
ALLIS-BABY BOWEL GRASPING FORCEPS.....	537	ARRUGA NEEDLE HOLDER.....	214	BARACANI INTERCHANGEABLE TIPS.....	472
ALLISON LUNG SPATULA.....	489	ARRUGA WOUND CURETTE.....	378	BARANY AIR BLOWER.....	405
ALM RETRACTOR.....	168	ASCH SEPTUM STRAIGHTENING FORCEPS.....	449	BARBARA HOOK.....	419
ALVIS FOREIGN-BODY CURETTE.....	374	ATRAUMA BULLDOG CLAMP.....	100	BARBAN GONIOTOMY KNIVES.....	373
AMNIOKOPPE.....	601	ATRAUMA BULLDOG CLAMP.....	100, 102	BARNHILL ADENOID CURETTE.....	450
AMNIOTOME BEACHAM.....	586	ATRAUMA CLAMP DEBAKEY.....	100	BARON SUCTION TUBE.....	336
AMPUTATION KNIVES CATLIN.....	44	ATRAUMA CLAMP DEBAKEY.....	103	BARR RECTAL-SPECULA.....	559
AMPUTATION KNIVES LANGENBECK.....	44	ATRAUMA CLAMP GLOVER.....	100	BARRAQUER CILIA FORCEPS.....	395
AMPUTATION KNIVES LISTON.....	44	ATRAUMA-BULLDOG CLAMP GLOVER.....	103	BARRAQUER EYE SPECULA.....	370
AMPUTATION KNIVES REDA.....	44	ATRAUMA-NEONATAL CLAMP.....	523	BARRAQUER EYESCISSORS.....	75
AMPUTATION SAW BIER.....	296	ATRAUMATIC FORCEPS ADSON-DEBAKEY.....	81/2	BARRAQUER FIXATION FORCEPS.....	390
AMPUTATION SAW CHARRIERE.....	296				
AMPUTATION SAW SATTERLEE.....	296				

**Index
Indice
Indice
Verzeichnis**

BARRAQUER KERATOPLAST-KNIVES.....	373	BIPOLAR-CABLE.....	633	BONE HOLDING FORCEPS.....	249
BARRAQUER NEEDLE HOLDER.....	217	BIPOLAR-TISSUE FORCEPS.....	630, 631	BONE HOLDING FORCEPS BIRCHER-GANSKE.....	246
BARRAQUER NEEDLE HOLDER.....	216, 217	BIPOLAR-TISSUE FORCEPS BAJONNET.....	632	BONE HOLDING FORCEPS DINGMANN.....	246
BARRAQUER-KATZIN IRIS TISSUE FORCEPS.....	384	BIRCHER-GANSKE BONE HOLDING FORCEPS.....	246	BONE HOLDING FORCEPS FARABEIF.....	243
BARRET HOOK FORCEPS.....	582	BIRKETT HEMOSTATIC CLAMP.....	116	BONE HOLDING FORCEPS FARABEIF-L.....	243
BARTON OBSTETRICAL FORCEPS.....	603	BISHOP-HARMAN IRIS TISSUE FORCEPS.....	386	BONE HOLDING FORCEPS FERGUSSON.....	243
BATTERY HANDLE F. COLD LIGHT.....	33	BISHOP-HARMAN IRRIGATION CANNULA.....	394/1	BONE HOLDING FORCEPS KERN.....	244
BATTERY HANDLE F. WARM LIGHT.....	32	BLADDER RETRACTORS LEGUE.....	553	BONE HOLDING FORCEPS LAMBOTTE.....	244
BAUMGARTNER NEEDLE HOLDER.....	208	BLADDER RETRACTORS MILLIN.....	552	BONE HOLDING FORCEPS LANE.....	244
BEACHAM AMNIOTOME.....	586	BLADDER RETRACTORS THOMSON-WALKER.....	552	BONE HOLDING FORCEPS LANGENBECK.....	243
BECHERT NUCLEUS ROTATOR.....	379	BLADDER RETRACTORSJUDD-MASSON.....	552	BONE HOLDING FORCEPS LEWIN.....	246
BECK ANASTOMOSIS KL.....	520	BLADDER SPATULA KOCHER.....	552	BONE HOLDING FORCEPS REDA.....	246, 247
BECK VASCULAR CLAMP.....	516	BLADDER SPATULA LEGUEU.....	552	BONE HOLDING FORCEPS REILL.....	248
BECKER CYSTOTOM.....	375	BLADDER SPREADER MILLIN.....	553	BONE HOLDING FORCEPS SEMB.....	243
BECKMANN ADENOID CURETTE.....	450	BLADE SCALPEL.....	42	BONE HOLDING FORCEPS ULRICH.....	248
BECKMANN RETRACTORS.....	176	BLADEBREAKER CASTROVIEJO.....	45	BONE HOLDING FORCEPS VAN BUREN.....	249
BECKMANN-ADSON RETRACTORS.....	175	BLADEBREAKER REDA.....	45	BONE HOLDING FORCEPS VERBRUGGE.....	245
BECKMANN-EATON RETRACTORS.....	176	BLADEBREAKER TROUTMAN-CHRIS.....	45	BONE KNIVES.....	44
BED PAN.....	621	BLADE-REMOVER.....	42	BONE LEVERS.....	284, 288
BEEBEE CROWNSCISSORS.....	68	BLADES RAZOR.....	45	BONE LEVERS BENNETT.....	283
BEER CILIA FORCEPS.....	395	BLAKE GALL STONE FORCEPS.....	531	BONE LEVERS BLOUNT.....	288
BEESON PLASTER RETRACTOR.....	232	BLAKE UTERINE CURETTE.....	595	BONE LEVERS HOHMANN.....	284
BELLUCCI MICRO-EAR SCISSORS.....	413	BLOHMKE TONSIL FORCEPS.....	467	BONE LEVERS HOHMANN.....	285
BELLUCCI MICRO-SCISSORS.....	417	BLOOD VESSEL CLAMP DIETRICH.....	510	BONE LEVERS HOHMANN MINI.....	286
BENDER.....	322	BLOOD VESSEL CLAMP MORRIS-DEBAKEY.....	506	BONE LEVERS KOENIG.....	283
BENDER LANE.....	325	BLOOD VESSEL CLAMP WEBER.....	501	BONE LEVERS LANGE-HOHMANN.....	286
BENGOLEA HEMOSTATIC CLAMP.....	112	BLOUNT BONE LEVERS.....	288, 289	BONE LEVERS SMILLIE.....	291
BENNETT BONE LEVERS.....	283	BLOWER KABIERKE.....	405	BONE LEVERS VERBRUGGE-MÜLLER.....	287
BENSAUDE PROCTOSCOPE.....	565	BLUMENTHAL BONE RONGEUR.....	236	BONE PLATE HOLDING FORCEPS LANE.....	325
BENSON PYLORUSRETRACTOR.....	544	BODENHAMMER RECTAL-SPECULA.....	559	BONE RONGEUR ADSON.....	236
BERENS DISCISION KNIVES.....	372	BOEHLER EXTENSION BOW.....	312	BONE RONGEUR BANE-HARTMANN.....	237
BERGMANN BANDAGE SCISSORS.....	69/1	BOERMA OBSTETRICAL FORCEPS.....	604	BONE RONGEUR BEYER.....	237, 238
BERGMANN HAMMER.....	272	BOETTCHER TONSIL SCISSORS.....	59	BONE RONGEUR BLUMENTHAL.....	236
BERKE MUSCLE FORCEPS.....	389	BÖHLER BONE CUTTING FORCEPS.....	241	BONE RONGEUR BOEHLER.....	238
BERLINER PERCUSSION HAMMER.....	24	BÖHLER BONE RONGEUR.....	238	BONE RONGEUR CLEVELAND.....	235
BERNHARD TOWEL CLAMP.....	133	BOIES ELEVATOR.....	277	BONE RONGEUR ECHLIN.....	240
BERRY WIRE FORCEPS.....	319	BONACCOLTO STRABISMUS FORCEPS.....	385	BONE RONGEUR FRIEDMAN-MICRO.....	234
BETHUNE RIB SCISSORS.....	481	BONE CURETTES.....	255, 256	BONE RONGEUR FRIEDMAN-MINI.....	234
BEYER BONE RONGEUR.....	237, 238	BONE CURETTES BRUNS.....	251, 254	BONE RONGEUR FRYK-HOLM.....	230
BIEMER APPLIER FORCEPS.....	361, 366	BONE CURETTES BUSHE.....	256	BONE RONGEUR JANSEN.....	237
BIEMER APPROXIMATOR.....	366	BONE CURETTES DAUBENSPECK.....	255	BONE RONGEUR KLEINERT-KUTZ.....	237
BIEMER VASCULAR CLIP.....	361	BONE CURETTES HALLE.....	253	BONE RONGEUR LEMPERT.....	237
BIEMER-MÜLLER APPROXIMATOR.....	363	BONE CURETTES JACOBSON.....	257	BONE RONGEUR LUER.....	236
BIER AMPUTATION SAW.....	296	BONE CURETTES JANSEN.....	257	BONE RONGEUR MARQUARD.....	239
BILLEAU EAR LOOP.....	409	BONE CURETTES LEMPERT.....	256	BONE RONGEUR MAYFIELD.....	238
BIOPSY CURETTE HEANY.....	587	BONE CURETTES MARTINI.....	257	BONE RONGEUR MEAD.....	235
BIOPSY CURETTE KEVORKIAN.....	587	BONE CURETTES SCHEDE.....	251	BONE RONGEUR OLIVECRONA.....	237
BIOPSY CURETTE NOVAK.....	587	BONE CURETTES SCOVILLE.....	253	BONE RONGEUR RUSKIN.....	239
BIOPSY CURETTE RANDALL.....	587	BONE CURETTES SPINAL.....	253	BONE RONGEUR SAUERBRUCH.....	240
BIOPSY CURETTE TYPE MÜNCHEN.....	587	BONE CURETTES SPRATT.....	251	BONE RONGEUR SCAGLIETTI.....	240
BIOPSY FORCEPS ALEXANDER.....	589	BONE CURETTES VOLKMANN.....	251, 257	BONE RONGEUR SEMB.....	240
BIOPSY FORCEPS BABY BURKE.....	590	BONE CURETTES WILLIGER.....	255, 257	BONE RONGEUR SMITH-PETERSEN.....	238
BIOPSY FORCEPS BURKE.....	590	BONE CUTTING FORCEPS BOEHLER.....	241	BONE RONGEUR STELLBRINK.....	234
BIOPSY FORCEPS EPPENDORFER.....	590	BONE CUTTING FORCEPS LISTON.....	241	BONE RONGEUR ZAUFAL-JANSEN.....	238
BIOPSY FORCEPS FAURE.....	588	BONE CUTTING FORCEPS MCINDOE.....	241	BONE RONGEURLEKSELL-STILLE.....	240
BIOPSY FORCEPS KERVORKIAN-PACIFIC.....	592	BONE CUTTING FORCEPS RUSKIN.....	241	BONE RONGEURSTILLE-LUER.....	239
BIOPSY FORCEPS KEVORKIAN.....	589	BONE CUTTING FORCEPS SEMB.....	242	BONE RONGEURSTILLE-RUSKIN.....	239
BIOPSY FORCEPS KEVORKIAN.....	591	BONE CUTTING FORCEPSSCOTTE-K.....	241	BONEFENDER NAIL BENDER.....	322
BIOPSY FORCEPS MAXI GRASPER.....	593	BONE CUTTING FORCEPSSITTLE-K.....	241, 242	BONEHOOK VOLKMANN.....	156
BIOPSY FORCEPS SCHUBERT.....	588	BONE FILES.....	612/1	BONERASP.....	294
BIOPSY FORCEPS SCHUMACHER.....	588, 589	BONE HAND DRILLS BUNELL.....	299	BONERASP PUTTI.....	314
BIOPSY FORCEPS THOMAS-GAYLOR.....	588	BONE HAND DRILLS HUDSON.....	299	BONEWIRE SOFT.....	294
BIOPSY FORCEPS TISCHLER-DOWN.....	591	BONE HAND DRILLS KIRSCHNER.....	299	BONN IRIS TISSUE FORCEPS.....	387
BIOPSY FORCEPS TISCHLER-KERVORKIAN.....	592	BONE HAND DRILLS MOORE.....	298	BONNEY ANATOMIC TISSUE FORCEPS.....	388
BIOPSY FORCEPS TISCHLER-MORGAN.....	591	BONE HAND DRILLS RALK.....	300	BONNEY SURGICAL TISSUE FORCEPS.....	388
BIOPSY FORCEPS TOWNSEND MINI.....	591	BONE HAND DRILLSSTILLE-SHERMAN.....	298	BOSE TRACHEA HOOK.....	476, 477
BIOPSY FORCEPS TOWNSEND TISCHLER MINI.....	591	BONE HAND DRILLSSTILLE-FELDMAN.....	298	BOUCHERON EAR SPECULA.....	399
BIOPSY FORCEPS VAN DOREN.....	588	BONE HOLDING CLAMP FELDHEIM.....	249	BOWEL CLAMP BABY-KOCHER.....	540
BIOPSY FORCEPS WITTNER.....	589	BONE HOLDING CLAMP GERSTER.....	250	BOWEL CLAMP BRUNNER.....	543
BIOPSY FORCEPSTISCHLER-MORGAN.....	590	BONE HOLDING CLAMP LAMBERT-LOWMAN.....	249	BOWEL CLAMP DOYEN.....	542
BIOPSY NEEDLE MENGHINI.....	206	BONE HOLDING CLAMP LOWMAN.....	249	BOWEL CLAMP FEHLAND.....	540
BIOPSY NEEDLEFRANKLIN-SILVERMANN.....	206	BONE HOLDING CLAMP LOWMAN-HOGLUND.....	249	BOWEL CLAMP KOCHER.....	540
BIOPSY-SUCTION CURETTE.....	600	BONE HOLDING FORCEPS.....	249	BOWEL CLAMP MAYO-ROBSON.....	541

**Index
Indice
Indice
Verzeichnis**

BOWEL CLAMP PAYR.....	548	BRUNNER RIB SCISSORS.....	481	CATARACT KNIVES DEUTSCHMANN.....	371
BOWEL CLAMP RESANO.....	542	BRUNS BANDAGE SCISSORS.....	70	CATARACT KNIVES GRAEFE.....	371
BOWEL CLAMP SCUDDER.....	541	BRUNS BONE CURETTES.....	251, 254	CATARACT LOOP ARLT.....	378
BOWEL CLAMPSTONE-WATT.....	545	BRUSH DISPENCOR.....	611	CATARACT LOOP SNELLEN.....	378
BOWEL GRASPING FORCEPS ALLIS.....	537	BRYANT DRESSINGFORCEPS.....	137	CATARACT LOOP WEBER.....	378
BOWEL GRASPING FORCEPS ALLIS-ADAIR.....	537	BUCHWALD TONGUE DEPRESSORS.....	451	CATARACT LOOP WILDER.....	378
BOWEL GRASPING FORCEPS ALLIS-BABY.....	537	BUCK EAR CURETTE.....	407	CATETHER INTRODUCING FORCEPS MAGILL.....	28
BOWEL GRASPING FORCEPS ATRAUMA.....	111	BUCK FOREIGN-BODY LEVER.....	412	CATETHER FORCEPS COOLEY.....	510
BOWEL GRASPING FORCEPS BABCOCK.....	539	BUCK PERCUSSION HAMMER.....	24	CATETHER GUIDE GUYON.....	554
BOWEL GRASPING FORCEPS COLLIN.....	539	BUCK-GRAMCKO BONE LEVERS.....	285	CATLIN AMPUTATION KNIVES.....	44
BOWEL GRASPING FORCEPS DOYEN-BABY.....	540	BUCK-GRAMCKO BONE LEVERS.....	285	CAUTER WADSWORTH-TODD.....	378
BOWEL GRASPING FORCEPS DUVAL.....	539	BUIE RECTAL ABSUCTION TUBE.....	566	CERVICAL TRACTION TONG CRUTCHFIELD.....	327
BOWEL GRASPING FORCEPS JUDD-ALLIS.....	538	BULLDOG CLAMP ATRAUMA.....	100	CHALAZIO CURETTE AXENFELD.....	377
BOWEL GRASPING FORCEPS LITTLEWOOD.....	538	BULLDOG CLAMP DEBAKEY.....	100, 103	CHALAZIO CURETTE HEBRA.....	377
BOWEL GRASPING FORCEPS LOCKWOOD-ALLIS.....	538	BULLDOG CLAMP DIETRICH.....	101	CHALAZIO CURETTE MEYHOEFER.....	377
BOWEL GRASPING FORCEPS THOMS-ALLIS.....	538	BULLDOG CLAMP GLOVER.....	103	CHALAZIO TISSUE FORCEPS AYER.....	393
BOWEL GRASPING FORCEPS WILLIAMS.....	539	BULLDOG CLAMP JOHNS-HOPKINS.....	104	CHALAZIO TISSUE FORCEPS DESMARRES.....	393
BOWEL SPATULA HABERER.....	143/1	BÜLOW-GUNAR-HEY TUBINGCLAMP.....	130	CHALAZIO TISSUE FORCEPS LAMBERT.....	393
BOWEL SPATULA LERICHE.....	143/2	BURKE UTERINE CURETTE.....	597	CHAPUT TISSUE GRASPING FORCEPS.....	110
BOWEL SPATULA REVERDIN.....	143/1	BUNELL BONE HAND DRILLS.....	299	CHARNLEY ABDOMINALRETRACTORS.....	289
BOWEL SPATULA RIBBON.....	143	BUNELL TENDON GUIDE.....	294	CHARRIERE AMPUTATION SAW.....	296
BOWMAN DISCISION KNIVES.....	372	BUNELL TENDON PASSING INSTR.....	292	CHEATLE STERILIZATION FORCEPS.....	227
BOWMAN DISCISION NEEDLE GERADE.....	374	BUNGE EXENTERATIONSLS.....	378	CHEEK RETRACTORSTERNBERG.....	453
BOWMAN EYE SPECULA.....	370	BUNT STERILIZATION CLAMP.....	227	CHEEKSTEIN NEEDLE HOLDER.....	210
BOWMAN LACHRYMAL PROBES.....	361	BURCH FIXATION FORCEPS.....	373	CHELSEA-EATON PROCTOSCOPE.....	563
BOX PETRI.....	620	BURKE BIOPSY FORCEPS.....	590	CHERON DRESSINGFORCEPS.....	137
BOYNTON NEEDLE HOLDER.....	214	BUSCH EPISOTOMY SCISSORS.....	64	CHERRY LAMINECTOMY RETRACTOR.....	488
BOZEMANN DRESSINGFORCEPS.....	138	BUSHE BONE CURETTE.....	256	CHEST SUPPORT KLEINSASSER.....	366
BOZEMANN NEEDLE HOLDER.....	211	BUTTONPROBES JACOBSON.....	335	CHEVALIER-JACKSON.....	473
BOZEMANN-DOUGLAS DRESSINGFORCEPS.....	138			CHEVALIER-JACKSON TRACHEA CANNULA.....	479
BRAIN KNIVES.....	48			CHILDE CLIP FORCEPS.....	224
BRAIN SPATULA DAVIS.....	337	C		CHILDREN ATRAUMA VASCULAR CLAMP.....	526
BRAINSPATULA CUSHING.....	336	CABLE BIPOLAR.....	633	CHISEL NEIVERT-ANDERSON.....	442
BRAINSPATULA CUSHING.....	369	CALIPER TOWNLEY.....	26	CHISELS.....	259, 264
BRAINSPATULA HEIFETZ.....	369	CALPERS.....	26	CHISELS ALEXANDER.....	259
BRAINSPATULA OLIVECRONA.....	336	CANFIELD TONSIL-KNIVES.....	466	CHISELS ALEXANDER.....	259
BRAND TENDON GRASPING INSTRUMENT.....	293	CANNULA.....	406	CHISELS BRUNETTI.....	268
BRAND TENDON PASSING INSTR.....	294	CAPLAN NOSE FORCEPS.....	428	CHISELS COTTLE.....	440
BRAUN GRANIPLAST.....	607	CAPSULA SCISSORS RESANO.....	53/2	CHISELS HIBBS.....	265
BRAUN DECAPITATING HOOK.....	607	CAPSULAR FORCEPS ARRUGA.....	391	CHISELS HOKK.....	265
BRAUN HOOK FORCEPS.....	582	CAPSULAR FORCEPS CASTROVIEJO.....	391	CHISELS KILLIAN.....	442/1
BRAUN UTERINE-DEPRESSOR.....	586	CAPSULAR FORCEPS ELSCHNIG.....	391	CHISELS LAMBOTTE.....	261
BRAUN-STADLER EPISOTOMY SCISSORS.....	64	CAPSULAR FORCEPS FUCHS.....	391	CHISELS LEXER.....	263
BREAST RETRACTOR.....	198	CAPSULAR FORCEPS GILL-ARRUGA.....	390	CHISELS MINI-LAMBOTTE.....	262
BREISKY VAGINAL SPECULA.....	577	CAPSULAR FORCEPS HESS.....	391	CHISELS NOVOTEX.....	264
BREITEN-MEASURING INSTRUMENT.....	594	CAPSULAR FORCEPS KALT.....	391	CHISELS OBWEGESER.....	463
BRIDGE HEMOSTATIC CLAMP.....	116	CAPSULAR FORCEPS SCHWEIGGER.....	391	CHISELS SMITH-PETERSEN.....	261
BRISTOW BONE LEVERS.....	290	CAPSULAR FORCEPS TERSON.....	391	CHISELSBLADE.....	266
BRISTOW BONE LEVERS.....	290	CAPSULAR GRASPING FORCEPS MILLIN.....	526	CHISELSSTILLE.....	260
BRODIE PROBES.....	199	CARDIOVASCULAR CLAMP.....	551	CILIA FORCEPS BARRAQUER.....	395
BRONCHO.FORCEPS CHEVALIER-JACK.....	473	CARMALT SPLINTER TISSUE FORCEPS.....	91	CILIA FORCEPS BEER.....	395
BRONCHUS CLAMP.....	126	CAROLL TENDON GRASPING INSTRUMENT.....	293	CILIA FORCEPS DOUGLAS.....	395
BRONCHUSCLAMP FINOCCHIETTO.....	490	CAROTIS-SHUNT CLAMP JAVID.....	511	CILIA FORCEPS GRADLE.....	395
BRONCHUSCLAMP HARRINGTON.....	490	CARPENTER TONSIL KNIVES.....	465	CILIA FORCEPS LITTAUER.....	395
BRONCHUSCLAMP LEES.....	504	CARTILAGE KNIVES.....	47	CILIA FORCEPS REDA.....	395
BRONCHUSCLAMP PRICE-THOMAS.....	490	CASPAR HEMOSTATS.....	258	CINELLI SEPTUM CHISELS.....	441
BRONCHUSCLAMP SEMB.....	491	CASPAR RETRACTORS.....	179, 180	CIRCULAR RONGEUR.....	432
BROPHY ANATOMIC TISSUE FORCEPS.....	84	CASTANEDA NEONATAL VASCULAR CLAMP.....	527	CIRCUMCISIONS INSTRUMENT.....	556
BROPHY SURGICAL TISSUE FORCEPS.....	84	CASTROVIEJO PROBE.....	381	CITELLI RONGEUR.....	430
BROWN NEEDLE HOLDER.....	209	CASTROVIEJO BLADEBREAKER.....	391	CLAMP VASEKTOMIE.....	553/2
BROWN TISSUE FORCEPS.....	83	CASTROVIEJO CAPSULAR FORCEPS.....	45	CLAMPHOLDING.....	326
BRUENINGS.....	468, 472	CASTROVIEJO CYCLODIALYSIS SPATULA.....	379	CLAR HEAD LIGHTS.....	22
BRUENINGS EAR SPECULA.....	401	CASTROVIEJO DISCISION KNIVES.....	372	CLARK EYE SPECULA.....	370
BRUENINGS INTERCHANGEABLE TIPS.....	472	CASTROVIEJO EYE SPECULA.....	371	CLAYMAN TONSIL NEEDLE.....	466
BRUENINGS SEPTUM FORCEPS.....	425	CASTROVIEJO FIXATION FORCEPS.....	390	CLAYMAN.....	376
BRUENINGS TONGUE DEPRESSORS.....	451	CASTROVIEJO HORNYSKINSCISSORS.....	79	CLEANING PISTOL.....	626
BRUENINGS TONSIL-KNIVES.....	466	CASTROVIEJO MEASURANCE CIRCLE.....	380	CLEVELAND BONE RONGEUR.....	235
BRUNETTI CHISELS.....	268	CASTROVIEJO NEEDLE HOLDER.....	215	CLIP FORCEPS CHILDE.....	224
BRÜNINGS-LUCAS CHISELS.....	260	CASTROVIEJO TISSUE FORCEPS.....	392	CLIP FORCEPS COLLIN.....	224
BRUNNER BOWEL CLAMP.....	543	CASTROVIEJO-MICRO NEEDLE HOLDER.....	215	CLIP FORCEPS MICHEL.....	224
BRUNNER GUIDEPROBES.....	221	CASTROVIEJO-STANDARD NEEDLE HOLDER.....	216	CLIP FORCEPSRICHTER-HEATH.....	224
BRUNNER GUIDEPROBES.....	221	CATARACT CURETTE DAVIEL.....	377	CLIP MICHEL.....	224
BRUNNER RETRACTOR.....	167	CATARACT CURETTE GRAEFE.....	377	CLIP TISSUE FORCEPS HEGENBARTH.....	224
		CATARACT CURETTE KNAPP.....	378		

**Index
Indice
Indice
Verzeichnis**

CLIP TISSUE FORCEPS MICHEL.....	224	COTLE FIXATION FORCEPS.....	410	D	
CLIP TISSUE FORCEPS WACHENFELDT.....	224	COTTLE HAMMER.....	273	DANDY HEMOSTATIC CLAMP.....	109
CLIP-APPLIER FORCEPS.....	523, 524	COTTLE NOSE HOOK.....	447, 447/1	DANDY NERVE HOOK.....	328
CLOWARD LAMINA SPREADER.....	339	COTTLE NOSE SCISSORS.....	59	DARLING RETRACTORS.....	178
CLOWARD LAMINECTOMY RETRACTOR FORCEPS.....	342	COTTLE NOSE SPECULA.....	423	DARTIGUES UTERINE-GRASPING FORCEPS.....	585
CLOWARD RETRACTORS.....	178	COTTLE SCISSORS.....	56	DASTOOR STRABISMUS FORCEPS.....	386
COAKLEY ANTRUM CURETTE.....	449	COTTLE SEPTUM CHISELS.....	440	DASTOOR SUCTION TUBE.....	380
COAKLEY TROCAR.....	204	COTTLE SEPTUM ELEVATOR.....	439	DAUBENSPECK BONE CURETTES.....	255
COBB CURETTE.....	252	COTTLE SEPTUM KNIVES.....	435	DAVIDSON(SCAPULA) RETRACTOR.....	166
COBB GOUGES.....	262	COTTLE SKIN HOOK.....	447, 448	DAVIEL CATARACT CURETTE.....	377
COBB RASPATORIES.....	280	COTTLE-JOSEPH SEPTUM.....	439	DAVIS BRAIN SPATULA.....	337
COLCLOUGH INTERVERTEBRAL DISC RONGEUR.....	344/1	COTTLE-KAZANJIAN BONE CUTTING FORCEPS.....	241	DAVIS DURA DISSECTOR.....	379
COLD LIGHT GUIDE HOLLINGER.....	37	COTTLE-NEIVERT.....	448	DAVIS FOREIGN-BODY NEEDLE.....	374
COLD LIGHT GUIDE JACKSON.....	37	COTTON-APPLICATOR.....	230	DAVIS STERILIZATION TISSUE FORCEPS.....	227
COLD LIGHTCLAMP FOR AMNIOSCOPE.....	601	COTTON-APPLICATOR FARRELL.....	203	DAVIS-BOYLE SPERRE.....	455
COLLER-CRILE HEMOSTATIC CLAMP.....	106	COTTON-APPLICATOR JOBSON-HORNBYE.....	203	DAVIS-MEYER MOUTH GAG.....	457
COLLIER NEEDLE HOLDER.....	208	COTTON-APPLICATOR REDA.....	203	DAY HOOK.....	409
COLLIER PELVIMETER.....	605	COTTON-APPLICATOR TOBOLD.....	203	DE BAKY NEEDLE HOLDER.....	210
COLLIN ABDOMINAL RETRACTORS.....	190	COTTON-APPLICATOR UCKERMANN.....	203	DE BAKY VASCULAR CLAMP.....	494
COLLIN BOWEL GRASPING FORCEPS.....	539	COXETER METAL CATHETER.....	555	DE BAKY VASCULAR CLAMP.....	494
COLLIN CLIP FORCEPS.....	224	CRAFOOD-SELLORS HEMOSTATIC CLAMP.....	118	DE BAKY VASCULAR SCISSORS.....	60, 61
COLLIN DRESSING FORCEPS.....	137	CRAFOOD HEMOSTATIC CLAMP.....	118	DE BAKY VASCULAR DILATOR.....	529
COLLIN DYNAMOMETER.....	25	CRAFOOD LUNG SCISSORS.....	65/2	DE BOER RIB SPREADER.....	486
COLLIN HAMMER.....	270	CRANIPLAST BRAUN.....	607	DE LEE OBSTETRICAL FORCEPS.....	602
COLLIN LOKTIE ABDOMINALE.....	191	CRANIPLAST TARNIER.....	607	DE MARTEL GUIDE SLEEVE.....	330
COLLIN NAVAL STRING CLAMP.....	605	CREGO ELEVATOR.....	282	DE MARTEL-WOLFSON.....	546
COLLIN PELVIMETER.....	605	CRILE HEMOSTATIC CLAMP.....	107	DEAN IRIS KNIVES.....	372
COLLIN RETRACTOR.....	139	CRILE NEEDLE HOLDER.....	213	DEAN TONSIL SCISSORS.....	59
COLLIN SCALPEL-HANDLE.....	40	CRILE NERVE HOOK.....	328	DEAVER DISSECTING SCISSORS.....	52
COLLIN TISSUE GRASPING FORCEPS.....	110	CRILE RETRACTOR.....	140	DEAVER RETRACTOR.....	145
COLLIN TONGUE FORCEPS.....	453	CRILE-MURRAY NEEDLE HOLDER.....	209	DEAVER-GRIP RETRACTOR.....	146
COLLIN UTERINE-GRASPING FORCEPS.....	585	CRILE-RANKIN HEMOSTATIC CLAMP.....	107	DEBAKEY AORTIC-ANAST CLAMP.....	505
COLLIN UTERINE-PROBES.....	586	CRILE-WOOD NEEDLE HOLDER.....	209	DEBAKEY ATRAUMA BULLDOG CLAMP.....	100, 103
COLLIN VAGINAL SPECULA.....	570	CRITCHETT EYE SPECULA.....	370	DEBAKEY ATRAUMA CLAMP.....	100
COLLIN-DUAL GRASPING PINZES.....	85	CROWN SCISSORS BEEBEE.....	68	DEBAKEY ATRAUMA CLAMP.....	103
COLLIN-HARTMANN RETRACTOR.....	141	CRUTCHFIELD HEAD HOLDER.....	327	DEBAKEY ATRAUMATIC TISSUE FORCEPS.....	99
COLLUMELLA TISSUE FORCEPS COTTLE.....	448	CRUTCHFIELD CERVICAL TRACTION TONG.....	327	DEBAKEY RETRACTOR.....	189/1
COLVER TONSIL FORCEPS.....	467	CUFF FOR LEG.....	295	DEBAKEY SUCTION TUBE.....	28
COMEDONE EXTRACTOR SAALFELD.....	608	CUFF FOR UPPER ARM.....	295	DEBAKEY VASCULAR CLAMP.....	507, 514, 515, 516
COMEDONE EXTRACTOR SCHAMBERG.....	608	CULLER IRIS SPATULA.....	378	DEBAKEY VASCULAR SCISSORS.....	61
COMEDONE EXTRACTOR UNNA.....	608	CUP MEDICINE.....	621	DEBAKEY VASCULAR SCISSORS TC.....	60
COMEDONE EXTRACTOR WALTON.....	608	CUP SPUTUM.....	621	DEBAKEY-BAHNSON ANEURYSM CLAMP.....	506
COMPRESSION BANDAGE.....	296	CURETTE ANTRUM.....	435	DEBAKEY-DIETRICH MINI BULLDOG CLAMP.....	101
CONE CURETTE.....	280	CURETTE COBB.....	252	DEBAKEY-MOSQUITO HEMOSTATIC CLAMP.....	509
CONE HEAD PUNCH.....	331	CURETTE FAULKNER.....	449	DEBAKEY-PEAN ATRAUMA CLAMP.....	512
CONE RASPATORIES.....	280	CURETTE FORCEPS.....	416	DEBAKEY-RANKIN ATRAUMA CLAMP.....	513
CONNIN-AMSLER MARKERS.....	380	CURETTE HOUSE.....	420	DECAPITATING HOOK BRAUN.....	607
CONVERSE NOSE HOOK.....	448	CUSCO VAGINAL SPECULA.....	570	DEJERINE PERCUSSION HAMMER.....	24
CONVERSE SEPTUM KNIVES.....	435	CUSHING (TAYLOR) TISSUE FORCEPS TC.....	87	DELEE RETRACTOR.....	574
COOLEY ANASTOMOSIS CLAMP.....	519, 520	CUSHING ANATOMIC TISSUE FORCEPS.....	83	DEMEL WIRE GUIDE NEEDLE.....	315
COOLEY AORTIC DILATOR.....	528	CUSHING BRAIN SPATULA.....	336, 369	DEMEL WIRE INSTRUMENT.....	315
COOLEY CATHETER FORCEPS.....	510	CUSHING DRILL.....	299	DENHART MOUTH GAGS.....	454
COOLEY RETRACTOR.....	148	CUSHING LAMINECTOMY RETRACTOR FORCEPS.....	340	DENIS-BROWNE ABDOMINAL RETRACTORS.....	186
COOLEY RIB SPREADER.....	487	CUSHING NERVE ENHOOK.....	328	DERF NEEDLE HOLDER.....	208
COOLEY VASCULAR CLAMP.....	518, 522	CUSHING RETRACTOR.....	152	DERMATOM HUMBY.....	50
COOLEY-DERRA ANASTOMOSIS CLAMP.....	519	CUSHING RETRACTOR.....	153	DERMATOM SILVER.....	50
COOLEY-NEONATAL RIB SPREADER.....	485	CUSHING RETRACTOR.....	151, 152, 153	DERMATOME SCHINK.....	49
COOLY SUCTION TUBE.....	28	CUSHING SURGICAL TISSUE FORCEPS.....	83	DERMATOME BLADE.....	49
COOPER LIGATUREE NEEDLE.....	219	CUSHING TISSUE FORCEPS.....	87	DESCHAMPS LIGATUREE NEEDLE.....	218
CORDES INTERCHANGEABLE TIPS.....	472	CUSHING-TAYLOR ANATOMIC TISSUE FORCEPS.....	87	DESJARDINS GALL STONE.....	532
CORNEAL DISSECTOR GREEN.....	374	CUZZI OVUM CURETTE.....	606	DESJARDINS GALL STONE CURETTE.....	534
CORNEAL DISSECTOR PATON.....	373	CYCLODIALYSIS SPATULA BANGERTER.....	379	DESJARDINS GALL STONE FORCEPS.....	521
CORNEAL SCARIFIER ELSCHNIG.....	373	CYCLODIALYSIS SPATULA CASTROVIEJO.....	379	DESJARDINS HEMOSTATIC CLAMP.....	131
CORNEAL SCARIFIER GILL.....	373	CYCLODIALYSIS SPATULA ELSCHNIG.....	379	DESMARRES CHALAZIO TISSUE FORCEPS.....	393
CORNEAL SCARIFIER SATO.....	373	CYCLODIALYSIS SPATULA WHEELER.....	379	DESMARRES RETRACTOR.....	183
CORNEAL SCARIFIER TOOK.....	373	CYSTOTOM BECKER.....	375	DEUTSCHMANN CATARACT KNIVES.....	371
CORNEAL SCLEROTOME KUHNH.....	373	CYSTOTOM GRAEFE.....	375	DEVILBISS HEAD FORCEPS.....	332
CORONAL BROW RETRACTOR.....	198	CZERNY HOOK FORCEPS.....	584	DIAGNOSTIC SET ECO 'C'.....	16
CORWIN-HEGAR WIRE FORCEPS.....	319	CZERNY RECTAL-SPECULA.....	559	DIAGNOSTIC SET ECO 'T'.....	16
CORYLLOS RETRACTOR.....	166			DIAGNOSTIC SET RI-MINI.....	17
CORYLLOS RIB SCISSORS.....	480			DIAGNOSTIC SET UNI III.....	15
COS MICRO-EAR FORCEPS.....	414			DIFFENBACH VASCULAR CLAMP.....	104
COTTLE COLUMELLA TISSUE FORCEPS.....	448				

**Index
Indice
Index
Verzeichnis**

DIETER MICRO-EAR FORCEPS.....	414	DRESSINGFORCEPS FOERSTER.....	136	EARSYRINGE REINER.....	406
DIETRICH BLOOD VESSEL CLAMP.....	510	DRESSINGFORCEPS GROSS-MAIER.....	134	ECHLIN BONE RONGEUR.....	240
DIETRICH MINI-BULLDOG CLAMP.....	101	DRESSINGFORCEPS LISTER (SINUS).....	137	ECO "C" DIAGNOSTIC SET.....	16
DIETRICH VASCULAR SCISSORS.....	60	DRESSINGFORCEPS M.SPERRER.....	135	ECO "T" DIAGNOSTIC SET.....	16
DILATION BOUGIE DITTEL.....	554	DRESSINGFORCEPS MAIER.....	134	EICKEN (KILLIAN) IRRIGATION CANNULA.....	433
DILATION BOUGIE GUYON.....	554	DRESSINGFORCEPS PELKMANN.....	137	ELEVATOR ALDERDYCE.....	282
DILATION BOUGIE VAN BUREN.....	554	DRESSINGFORCEPS RAMPLEY.....	136	ELEVATOR BOIES.....	277
DINGMANN BONE HOLDING FORCEPS.....	246	DRESSINGFORCEPS SIMS-MAIER.....	134	ELEVATOR CREGO.....	282
DINGMANN MOUTH GAGS.....	456	DRESSINGFORCEPS ULRICH.....	135	ELEVATOR DINGMANN.....	463, 463/3
DINGMANN RASPATORIES.....	463	DRESSINGTISSUE FORCEPS JACKSON.....	471	ELEVATOR KEY.....	282
DINGMANN RETRACTOR.....	463	DRILL.....	299	ELEVATOR LEMPERT.....	420
DINGMANN SPREADER.....	456	DRILL BITS.....	302	ELEVATOR LUNIATSCHEK.....	465
DIPLOMAT SPHYGMOMANOMETER.....	5	DRILL CUSHING.....	299	ELEVATOR MCDONALD.....	283
DISCISION KNIVES BERENS.....	372	DRILL ERRICO.....	299	ELEVATOR MURPHY-LANE.....	283
DISCISION KNIVES BOWMAN.....	372	DRILL MC KENZIE.....	299	ELEVATOR SAYRE.....	281
DISCISION KNIVES CASTROVIEJO.....	372	DRILL SUPPORT.....	310	ELEVATOR WATSON-CHEYNE.....	434
DISCISION KNIVES JAEGER.....	372	DRILL WIRE.....	299	ELEVATORIUM FREER.....	283
DISCISION KNIVES WHEELER.....	373	DRILLWIRE KIRSCHNER.....	306, 307	ELLIOT OBSTETRICAL FORCEPS.....	602
DISCISION KNIVES ZIEGLER.....	373	DRIVER KUENTSCHER.....	321	ELLIS FOREIGN-BODY GOUGES.....	372
DISCISION NEEDLE.....	374	DRIVERS.....	321	ELSCHING CAPSULAR FORCEPS.....	391
DISCISION NEEDLE BOWMAN.....	374	DUBOIS GYNECOLOGICAL SCISSORS.....	63	ELSCHING CORNEAL SCARIFIER.....	373
DISSECTING SCISSORS.....	52	DUEHRSEN ANATOMIC TISSUE FORCEPS.....	84	ELSCHING CYCLODIALYSIS SPATULA.....	379
DISSECTING SCISSORS.....	53/2	DUPLAY DRESSINGFORCEPS.....	134	ELSCHING FIXATION FORCEPS.....	389
DISSECTING SCISSORS DEAWER.....	52	DUPLAY HOOK FORCEPS.....	582	EMMETT FISTULA HOOK.....	594
DISSECTING SCISSORS JORGENSEN.....	53	DUPLEX STETHOSCOPE.....	23	ENDERNAL STEINMANN.....	307
DISSECTING SCISSORS LEXER.....	53	DUPUY-WEISS TONSIL KNIVES.....	466	ENDOSCOPE EASSEMBLEY.....	188
DISSECTING SCISSORS LEXER-BABY.....	53	DURA DISSECTOR.....	332	ENDOSCOPE WIREBASKET.....	623
DISSECTING SCISSORS LEXER-BABY TC.....	53	DURA DISSECTOR DAVIS.....	332	ENDOSPECULA KOGAN.....	577
DISSECTING SCISSORS MAYO.....	52	DURA DISSECTOR FRAZIER.....	333	ENGEL PLASTER CAST SAW.....	229
DISSECTING SCISSORS MAYO TC.....	52	DURA DISSECTOR HOEN.....	333	ENTEROTOMY SCISSORS.....	66
DISSECTING SCISSORS MAYO-NOBLE.....	52	DURA DISSECTOR HORSLEY.....	333	ENTROPIUM FORCEPS SNELLEN.....	393
DISSECTING SCISSORS MAYO-STILLE.....	52	DURA DISSECTOR MILLIGAN.....	332	ENUCLEATION CURETTE WELLS.....	378
DISSECTING SCISSORS MAYO-STILLE.....	52	DURA DISSECTOR MORGILL.....	332	ENUCLEATION SCISSORS.....	58
DISSECTING SCISSORS MAYO-STILLE TC.....	52	DURA DISSECTOR SACHS.....	332	EPIGLOTTIS RETRACTOR FRAENKEL.....	471
DISSECTING SCISSORS METZENBAUM.....	53/1	DURA DISSECTOR TOENNIS.....	332	EPIGLOTTIS RETRACTOR JACKSON.....	471
DISSECTING SCISSORS METZENBAUM.....	53/1	DURA DISSECTOR WOODSON.....	333	EPIGLOTTIS RETRACTOR REICHERT.....	471
DISSECTING SCISSORS METZENBAUM FINO.....	53/1	DURA HOOK.....	335	EPISOTOMY SCISSORS WALDMANN.....	64
DISSECTING SCISSORS METZENBAUM TC.....	53/1	DURA HOOK JACOBSON.....	335	EPKER OSTEOTOME.....	464/2
DISSECTING SCISSORS PECK-JOSEPH.....	74	DURA KNIVES KOOS.....	335	EPPENDORFER BIOPSY FORCEPS.....	590
DISSECTING SCISSORS TOENNIS-ADSON.....	65	DURAHOOK ADSON.....	328	ESMARCH BANDAGE SCISSORS.....	69/2
DISSECTING SCISSORS METZENBAUM FINO TC.....	53/1	DURANT GRASPING TISSUE FORCEPS.....	88	ESMARCH PLASTER KNIVES.....	233
DISSECTOR FISCH.....	420	DURASSCISSORS SCHMIEDEN-TAYLOR.....	65/1	ETHICON CLIP FORCEPS.....	524
DISSECTOR GORNEY.....	277	DUVAL BOWEL GRASPING FORCEPS.....	539	EVES TONSIL SNARE.....	468
DISSECTOR PENFIELD.....	333	DUVAL GRASPING TISSUE FORCEPS.....	85	EXACTA SPHYGMOMANOMETER.....	8
DITTEL DILATION BOUGIE.....	554	DYNAMOMETER COLLIN.....	25	EXENTERATION CURETTE BUNGE.....	378
DIX FOREIGN-BODY CHISELS.....	374	E.....		EXTENSIONS BOWS BOEHLER.....	312
DIX FOREIGN-BODY INSTRUMENT.....	380	EAR CATHETER HARTMANN.....	408	EXTENSIONS BOWS KIRSCHNER.....	312
DOUBLECURETTE VOLKMANN.....	257	EAR CURETTE BUCK.....	407	EXTENSIONS BOWS KIRSCHNER US.....	312
DOUGHTY TONGUE BLADE.....	458	EAR CURETTE GROSS.....	409	EXTIRPATIONSCHISELS ROLLET.....	374
DOUGLAS CILIA FORCEPS.....	395	EAR FORCEPS HARTMANN.....	411	EXTRACTION DISSECTOR LANG.....	378
DOUGLAS TONSIL KNIVES.....	466	EAR FORCEPS HEYMANN-KNIGHT.....	425	EXTRACTION HOOK.....	322
DOUGLAS TROCAR.....	205	EAR FORCEPS JANSEN.....	424	EXTRACTION HOOK KNAPP.....	375
DOYEN ABDOMINALRETRACTORS.....	189/1	EAR FORCEPS JITTAEU.....	411	EXTRACTION HOOK ROLLET.....	375
DOYEN BOWEL CLAMP.....	540	EAR FORCEPS LUCAC.....	410	EXTRACTION HOOK ARRUGA.....	375
DOYEN GYNECOLOGICAL SCISSORS.....	63	EAR FORCEPS TILLEY.....	411	EXTRAKTOR KUENTSCHER.....	322
DOYEN MYOMA A SCREW.....	594	EAR FORCEPS TROELTSCH.....	424	EYE CANNULA MCINTYRE.....	394
DOYEN PROBES.....	199	EAR FORCEPS WILDE (TROELTSCH).....	410	EYE CANNULA TYPE AIR INJECTION.....	394
DOYEN RASPATORIES.....	278	EAR KNIVES POLITZER.....	408	EYE CANNULA TYPE SHEETS.....	394/2
DOYEN RETRACTOR.....	163	EAR KNIVES SEXTON.....	408	EYE MAGNET REDA.....	395
DOYEN SCISSORS.....	63	EAR LEVER ZAUFAL.....	409	EYE SPECULA ARRUGA.....	370
DOYEN TOWEL CLAMP.....	133	EAR LEVER ZAUFAL-JANSEN.....	409	EYE SPECULA BARRAQUER.....	370
DOYEN UTERINE POLYP FORCEPS.....	585	EAR LOOP BILLEAU.....	409	EYE SPECULA BOWMAN.....	370
DOYEN VAGINAL SPECULA.....	574	EAR LOOP SHAPLEIGH.....	410	EYE SPECULA CASTROVIEJO.....	371
DOYEN-BABY BOWEL CLAMP.....	540	EAR SPECULA BOUCHERON.....	399	EYE SPECULA CLARK.....	370
DOYEN-JANSEN(MOLT).....	454	EAR SPECULA BRUNENJENS.....	401	EYE SPECULA CRITCHETT.....	370
DOYEN-JANSEN(MOLT) MOUTH GAGS.....	454	EAR SPECULA GRUBER.....	399	EYE SPECULA GRAEFFE.....	370
DOYEN-STILLE RETRACTOR.....	167	EAR SPECULA HARTMANN.....	399	EYE SPECULA LANCASTER.....	371
DRESSINGFORCEPS.....	135	EAR SPECULA HARTMANN.....	399	EYE SPECULA LISTER-BURCH.....	370
DRESSINGFORCEPS BOZEMANN.....	138	EAR SPECULA POLITZER.....	399	EYE SPECULA MELLINGER.....	370
DRESSINGFORCEPS BOZEMANN-DOUGLAS.....	138	EAR SPECULA RICHMAU-HOLMGREN.....	400	EYE SPECULA MELLINGER-AXENFELD.....	370
DRESSINGFORCEPS BRYANT.....	137	EAR SPECULA SIEGLE.....	402	EYE SPECULA MUELLER.....	371
DRESSINGFORCEPS CHERON.....	137	EAR SPECULA TOYNBEE.....	399	EYE SPECULA MURDOCK.....	370
DRESSINGFORCEPS COLLIN.....	137	EARPROBESSTACKE.....	199	EYE SPECULA PARK.....	371

**Index
Indice
Indice
Verzeichnis**

EYE SPECULA SMITH.....	370	FIXATION FORCEPS LESTER.....	389	GASS HOOK.....	376
EYE SPECULA WEEK.....	370	FIXIERFORC BURCH.....	373	GALUSS KOPFSCHWARTE.....	605
EYE SPECULA WILLIAMS.....	370	FIXIERVORRICHTUNG ROCHARD.....	186	GELPI ABDOMINALRETRACTORS.....	189/1, 189/2
EYE SPECULA ZIEGLER.....	371	FLAT FORCEPS.....	316, 317	GELPI HOOK.....	193
EYE SPECULAST.ENVENSON.....	371	FOERSTER DRESSINGFORCEPS.....	136	GERMIN HEMOSTATIC CLAMP.....	116
EYE SUCTION -IRRIGATION CANNULA.....	394	FOERSTER IRIS TISSUE FORCEPS.....	383	GERALD ANATOMIC TISSUE FORCEPS.....	85
EYESCISSORS BARRAQUER.....	75	FOMON NOSE RASP.....	444	GERALD SURGICAL TISSUE FORCEPS.....	87
EYESCISSORS NOYES.....	75	FOMON NOSE SCISSORS.....	58	GERSTER BONE HOLDING CLAMP.....	250
EYESCISSORS VANNAS.....	79	FOMON RASPATORIES.....	277	GERZOG HAMMER.....	270
EYESCISSORS WECKER.....	75	FOMON RHINOPLASTSCISSORS.....	65/1	GIERTZ-STILLE RIB SCISSORS.....	481
EYESCISSORS WESTCOTT.....	75	FOMON SEPTUM CHISELS.....	441	GIGLI SAW.....	332
F.....		FOMON SKIN HOOK.....	447/1	GILL CORNEAL SCARIFIER.....	373
FACE LIFT SCISSORS FREEMAN.....	74	FOMON TC NOSE RASP.....	445	GILL IRIS TISSUE FORCEPS.....	384
FACE LIFT SCISSORS GORNEY.....	73	FOREGGER LARYNGOSCOOP.....	29, 31	GILL-ARRUGA CAPSULAR FORCEPS.....	390
FACE LIFT SCISSORS KAYE.....	73	FOREIGN-BODY CHISELS DIX.....	374	GILL-HESS IRIS TISSUE FORCEPS.....	384
FACE LIFT SCISSORS REES.....	73	FOREIGN-BODY CURETTE ALVIS.....	374	GILLIES NEEDLE HOLDER.....	212
FANSLER PROCTOSCOPE.....	564	FOREIGN-BODY FORCEPS HARTMANN.....	412	GILLIES SKIN HOOK.....	448
FARABEUF BONE HOLDING FORCEPS.....	243	FOREIGN-BODY FORCEPS HARTMANN-HOFFMANN.....	412	GILLIES SURGICAL TISSUE FORCEPS.....	86
FARABEUF RASPORIESIES.....	274	FOREIGN-BODY FORCEPS HARTMANN-WULLSTEIN.....	412	GIL-VERNET RETRACTOR.....	152
FARABEUF RETRACTOR.....	139	FOREIGN-BODY FORCEPS MATHIEU.....	553/1	GLOVER TRAUMA CLAMP.....	100
FARABEUF-COLLIN RASPORIESIES.....	274	FOREIGN-BODY GOUGES ELLIS.....	374	GLOVER BULLDOG CLAMP.....	103
FARABEUF-LAMBOTTE BONE HOLDING FORCEPS.....	243	FOREIGN-BODY GOUGES WALTON.....	374	GLOVER VASCULAR CLAMP.....	515
FARRELL COTTON-APPLICATOR.....	203	FOREIGN-BODY INSTR. DIX.....	380	GLUCK RIB SCISSORS.....	480
FARRIOR EAR SPECULA.....	400	FOREIGN-BODY LEVER BUCK.....	412	GOELET RETRACTOR.....	141
FARRIOR EAR SPECULA.....	400	FOREIGN-BODY LEVER QUIRE.....	412	GOLDMANN-FOX GUMSCISSORS.....	67
FAULKNER CURETTE.....	449	FOREIGN-BODY NEEDLE.....	374	GOMEL MICROSURGICAL TISSUE FORCEPS.....	96
FAURE BIOPSY FORCEPS.....	588	FOREIGN-BODY NEEDLE DAVIS.....	374	GOMMEL MICRO-SCISSORS.....	80
FAURE PERITONEUMCLAMP.....	123	FOREIGN-BODY NEEDLE FRANCIS.....	374	GOINIOMETER F. FINGER.....	25
FAVALORO VASCULAR SCISSORS.....	61	FOREIGN-BODY NEEDLE LA FORCE.....	374	GOINIOMETER MOELTGEN.....	25
FEHLAND BOWEL CLAMP.....	542	FOREIGN-BODY NEEDLE LEVINSON.....	374	GOINIOTOMY KNIVES BARKAN.....	373
FEILCHENFELD TISSUE FORCEPS.....	91	FOX LUPUS CURETTE.....	608	GOINIOTOMY KNIVES SCHIEE.....	573
FELDHEIM BONE HOLDING CLAMP.....	249	FRAENKEL INTERCHANGEABLE TIPS.....	472	GOOD TONSIL SCISSORS.....	379
FERGUSSON BONE HOLDING FORCEPS.....	243	FRANCIS FOREIGN-BODY NEEDLE.....	374	GOODELL UTERINE DILATATOR.....	581
FERGUSSON FRAZIER STUCTION TUBE.....	337	FRANKLIN-SILVERMANN BIOPSY NEEDLE.....	206	GORNEY DISSECTOR.....	277
FERGUSSON GALL SINE CURETTE.....	533	FRAZIER ABDOMINALRETRACTORS.....	181	GORNEY FACE LIFT SCISSORS.....	73
FERGUSSON HAEMORRHOIDALCLAMP.....	109	FRAZIER DURA DISSECTOR.....	333	GOSSET ABDOMINALRETRACTORS.....	181
FERGUSSON SURGICAL SCISSORS.....	66	FRAZIER PUNCTION CANNULA.....	337	GOUGES.....	264
FERRIERA RETRACTOR.....	197	FRAZIER SKIN HOOK.....	149	GOUGES PARTSCH.....	259
FERRIS-SMITH LAMINECTOMY RETRACTOR FORCEPS.....	343	FREEMAN FACE LIFT SCISSORS.....	74	GOUGES COBB.....	262
FERRIS-SMITH SURGICAL TISSUE FORCEPS.....	85	FREEMAN RETRACTOR.....	198	GOUGES HIBBS.....	263
FERRIS-SMITH-KERRISON RONGEUR.....	344, 344/2	FREER ELEVATORIUM.....	434	GOUGES LEXER MINI.....	265
FIBERGLAS-LIGHT GUIDE KLEINSASSER.....	36	FREER SEPTUM CHISELS.....	439, 442	GOUGES WEST.....	442/1
FICHOCHIETTO-BABY RIB SPREADER.....	482	FREER SEPTUM ELEVATOR.....	437	GOUGES ZIELKE.....	264
FILES BONE.....	612/1	FREER SEPTUM KNIVES.....	434	GOUGESSTILLE.....	260
FINGER NAIL DRILL.....	297	FREER SKIN HOOK.....	448	GOURDET UTERINE CURETTE.....	599
FINGER PROTECTOR LANGENBECK.....	311	FRENZEL NYSTAGMUS SPECTACLES.....	20	GRADLE CILIA FORCEPS.....	395
FINGER RING SAW REDA.....	297	FRENZEL TONGUE DEPRESSORS.....	451	GRADLE OPHTHALMOLOGIC SCISSORS.....	57
FINGER RING SAW WALTON.....	297	FRIEDMANN MINI BONE RONGEUR.....	234	GRADUATED MEASURE.....	620
FINGER-GONIOMETER.....	25	FRIEDMANN SPECULA.....	577	GRAEFE CATARACT CURETTE.....	377
FINGERSAW LANGENBECK.....	296	FRITSCH RETRACTOR.....	163	GRAEFE CATARACT KNIVES.....	371
FINOCCHIETTO BRONCHUSCLAMP.....	490	FRYKHOLM BONE RONGEUR.....	240	GRAEFE CYSTOTOM.....	375
FINOCCHIETTO RIB SPREADER.....	482	FUCHS CAPSULAR FORCEPS.....	391	GRAEFE DISCISION KNIVES.....	372
FINOCCHIETTO NEEDLE HOLDER.....	211	FUCHSIG HEMOSTATIC CLAMP.....	113	GRAEFE DISCISION KNIVES.....	372
FINOCCHIETTO RIB SPREADER.....	484	FÜHR.PROBES BRUNNER.....	221	GRAEFE FIXATION FORCEPS.....	389
FINOCCHIETTO-BABY RIB SPREADER.....	482	FÜHR.PROBES PAYR.....	221	GRAEFE IRIS TISSUE FORCEPS.....	382
FINOCCHIETTO-BURFORD RIB SPREADER.....	483	FÜHR.PROBES VIENNA.....	221	GRAEFE SCISSORS.....	56
FINSEN RETRACTOR.....	168	G.....		GRAEFE STRABISMUS HOOK.....	375
FISCH DISSECTOR.....	420	GALEAHOOK YASARGIL.....	330	GRAEFE TISSUE FORCEPS.....	83
FISCH FINE HOOK.....	335	GALL DUCT DILATOR BAKES.....	420	GRAEVE HOOK.....	149
FISCHER IRIS TISSUE FORCEPS.....	384	GALL STONE CURETTE DESJARDINS.....	534	GRAEVE EYE SPECULA.....	379
FISH PROBES.....	199	GALL STONE CURETTE LUER-KOERTE.....	533	GRAHAM NERVE HOOK.....	328
FISHER TONSIL-KNIVES.....	466	GALL STONE CURETTE MAYO.....	534	GRASPING FORCEPS.....	415
FISTULA HOOK EMMETT.....	594	GALL STONE CURETTE MOOR.....	532	GRASPING FORCEPS LAHEY.....	479
FISTULA PROBES PRATT.....	563	GALL STONE FORCEPS BLAKE.....	531	GRASPING FORCEPS MARTEL.....	110
FISTULAPROBES LOCKHART-MUMMERY.....	200	GALL STONE FORCEPS DESJARDINS.....	531	GRASPING FORCEPS PRATT.....	110
FIXATION FORCEPS BARRAQUER.....	390	GALL STONE FORCEPS MAYO-BLAKE.....	531	GRASPING FORCEPS WILLET MARTEL.....	110
FIXATION FORCEPS CASTROVIEJO.....	390	GALL STONE FORCEPS MIXTER.....	531	GRASPING TISSUE FORCEPS COLLIN-DUVAL.....	85
FIXATION FORCEPS COTTLE.....	410	GALL STONE PROBES DESJARDINS.....	532	GRASPING TISSUE FORCEPS DURANTE.....	88
FIXATION FORCEPS ELSCHNING.....	389	GALL STONE PROBES MAYO.....	534	GRASPING TISSUE FORCEPS DUVAL.....	85
FIXATION FORCEPS GRAEFE.....	389	GALL STONE PROBES MOYNIHAN.....	532	GRASPING TISSUE FORCEPS LERCHE.....	83
FIXATION FORCEPS GREEN.....	390	GALLAHER ANTRUM RASP.....	446	GRASPING TISSUE FORCEPS RUSS MODELL.....	85
				GRAVE VAGINAL SPECULA.....	570

**Index
Indice
Index
Verzeichnis**

GRAY HEMOSTATIC CLAMP.....	121	HARGIS AWL.....	463	HEMOSTATIC CLAMP LAHEY.....	120
GREEN CORNEAL DISSECTOR.....	374	HARGIS MANDIBULAR BODY RETRACTOR.....	463/6	HEMOSTATIC CLAMP LAWRENCE.....	119
GREEN FIXATION FORCEPS.....	390	HARGIS RASPATORY.....	463/2	HEMOSTATIC CLAMP LERICHE.....	111
GREEN MUSCLE HOOK.....	375	HARKEN AURIKELCLAMP.....	503	HEMOSTATIC CLAMP LOVELACE.....	109
GREEN RETRACTOR.....	160	HARMS LACHRYMAL PROBES.....	381	HEMOSTATIC CLAMP LOWER.....	120
GREEN-ARMYtage.....	605	HARMS PROBES.....	333	HEMOSTATIC CLAMP MAYO-GUYON.....	122
GREVEN MICRO-EAR FORCEPS.....	414	HARRINGTON BRONCHUSCLAMP.....	490	HEMOSTATIC CLAMP MEEKER.....	119
GROSS EAR CURETTE.....	409	HARRINGTON HOOK.....	193	HEMOSTATIC CLAMP MICRO-HARTMANN.....	104
GROSS-MAIER DRESSINGFORCEPS.....	134	HARRINGTON-PEMBERTON RETRACTOR.....	147	HEMOSTATIC CLAMP MIXTER.....	119, 121
GRUBER EAR SPECULA.....	399	HARRINGTON RETRACTOR.....	408	HEMOSTATIC CLAMP MIXTER-BABY.....	119
GUIDE DRIVER.....	321	HARTMANN EAR CATHETER.....	408	HEMOSTATIC CLAMP MOYNIHAN.....	121
GUIDE NEEDLE REDON.....	207	HARTMANN EAR SPECULA.....	399	HEMOSTATIC CLAMP O'SHAUGNESSY.....	110
GUIDEPROBES KÖNIG.....	221	HARTMANN FOREIGN-BODY FORCEPS.....	412	HEMOSTATIC CLAMP OVERHOLT.....	124
GUIDEPROBES BRUNNER.....	221	HARTMANN FOREIGN-BODY LEVER.....	411	HEMOSTATIC CLAMP PEAN.....	110
GUIDEPROBES KIRSCHNER.....	221	HARTMANN HEMOSTATIC CLAMP.....	104	HEMOSTATIC CLAMP PEAN.....	108
GUIDEPROBES SCHMIEDEN.....	221	HARTMANN IRRIGATION CANNULA.....	433	HEMOSTATIC CLAMP PENNINGTON.....	109
GUIDEPROBES SCHMIEDEN-PAYR.....	221	HARTMANN NOSE SPECULA.....	422, 427	HEMOSTATIC CLAMP PROVIDENCE-HOSPITAL.....	106
GUILLEN SUCTION RASPATORIES.....	433/1	HARTMANN POLYP FORCEPS.....	424	HEMOSTATIC CLAMP ROBERTS.....	117
GUM SCISSORS LA GRANGE.....	69	HARTMANN TONGUE DEPRESSORS.....	452	HEMOSTATIC CLAMP ROCHESTER-CARMALT.....	109
GUMSCISSORS GOLDMAN-FOX.....	67	HARTMANN TUNING FORC.....	403	HEMOSTATIC CLAMP ROCHESTER-OCHSNER.....	108
GUMSCISSORS LOCKLIN.....	69	HARTMANN-HALLE NOSE SPECULA.....	421	HEMOSTATIC CLAMP ROCHESTER-PEAN.....	108
GUMSCISSORS QUINBY.....	67	HARTMANN-HOFFMANN FOREIGN-BODY FORCEPS.....	412	HEMOSTATIC CLAMP RUMEL.....	118
GUTHRIE SKIN HOOK.....	149	HARTMANN-WULLSTEIN FOREIGN-BODY FORCEPS.....	412	HEMOSTATIC CLAMP SAROT.....	117
GUYON CATHETER EINGUIDE.....	554	HAUGH MICRO-EAR FORCEPS.....	414	HEMOSTATIC CLAMP S-CVD MIXTER.....	116
GUYON DILATION BOUGIE.....	554	HAYES RECTUM-ANAST.KL.....	545	HEMOSTATIC CLAMP SPENCER-WELLS.....	109
GUYON HEMOSTATIC CLAMP.....	122	HEAD HOLDER CRUTCHFIELD.....	327	HEMOSTATIC CLAMP STILLE.....	122
GUYON KIDNEY CLAMP.....	122	HEAD LIGHTS CLAR KPLT.....	22	HEMOSTATIC CLAMP TOENNIS.....	117
GUYTON-LUNDSSGAARD SKLEROTOM.....	373	HEAD MIRRORS ZIEGLER.....	21	HEMOSTATIC CLAMP WIKSTROEM.....	117
GYNECOLOGICAL SCISSORS DOYEN.....	63	HEAD PUNCH CONE.....	331	HEMOSTATIC CLAMP ZENKER.....	118
GYNECOLOGICAL SCISSORS DUBOIS.....	63	HEANEY HYSTERECTOMYCLAMP.....	126	HEMOSTATIC CLAMP ZENKER.....	118
GYNECOLOGICAL SCISSORS SIEBOLD.....	62	HEANEY NEEDLE HOLDER.....	210	HEMOSTATIC CLAMP ZENKER.....	118
GYNECOLOGICAL SCISSORS SIMS.....	62	HEANY BIOPSY CURETTE.....	587	HEMOSTATIC CLAMP ZENKER.....	118
GYNECOLOGICAL SCISSORS WERTHEIM.....	63	HEANY RETRACTOR.....	164	HEMOSTATIC CLAMP ZENKER.....	118
		HEANY-BALLENANTINE HYSTERECTOMYCLAMP.....	127	HEMOSTATS.....	259
H.....		HEATH HAMMER.....	273	HENKE TONSIL-ELEVATOR.....	465
HABERER BOWEL SPATULA.....	143/1	HEATH SUTURE SCISSORS.....	66	HENKIN RETRACTORS.....	170
HAEMORRHOIDAL LIGATOR MC GINNEY.....	568	HEBRA CHALAZIO CURETTE.....	377	HENNING PLASTER RETRACTOR.....	232
HAEMORRHOIDALCLAMP FERGISSON.....	109	HEGAR UTERINE DILATOR.....	578, 579	HEPP-SCHIEDL MICRO-SCISSORS.....	78
HAEMORRHOIDALFORCEPS HEYWOOD-SMITH.....	567	HEGENBARTH CLIP TISSUE FORCEPS.....	224	HERRICK NIERENSTIELCLAMP.....	123
HAGLUND-STILLE PLASTER RETRACTOR.....	232	HEIFETZ BRAIN SPATULA.....	369	HESS CAPSULAR FORCEPS.....	391
HAIGHT RIB SPREADER.....	487	HEIMING KIDNEY STONE FORCEPS.....	536	HESS IRIS TISSUE FORCEPS.....	384
HAJEK HAMMER.....	273	HEISS HEMOSTATIC CLAMP.....	112	HEYMANN SEPTUM FORCEPS.....	425
HAJEK SEPTUM CHISELS.....	442/1	HEISTER MOUTH GAGS.....	454	HEYMANN NOSE SCISSORS.....	58
HAJEK-BALLENGER ELEVATOR.....	439	HEMOSTATIC CLAMP ADSON.....	112	HEYMANN-KNIGHT EAR FORCEPS.....	425
HAJEK-KOFLER RONGEUR.....	429, 431	HEMOSTATIC CLAMP ADSON-BABY.....	113	HEYWOOD-SMITH HAEMORRHOIDAL FORCEPS.....	567
HALLE BONE CURETTES.....	253	HEMOSTATIC CLAMP ADSON-BABY.....	113	HIBBS CHISELS.....	265
HALLE SEPTUM ELEVATOR.....	437	HEMOSTATIC CLAMP BAINBRIDGE.....	120	HIBBS GOUGES.....	265
HALOGEN LAMP FOR LARYNGOSCOPE.....	29	HEMOSTATIC CLAMP BENGOLEA.....	112	HIBBS RETRACTOR.....	164
HALSEY NEEDLE HOLDER.....	208	HEMOSTATIC CLAMP BIRKETT.....	116	HILL-FERGISSON RECTAL-SPECULA.....	560
HALSTED-MOSQUITO HEMOSTATIC CLAMP.....	105	HEMOSTATIC CLAMP BRIDGE.....	116	HIRSCHMANN SPATULA.....	331
HAMMER.....	270, 272	HEMOSTATIC CLAMP COLLER-CRILE.....	106	HIRSCHMANN ANOSCOPE.....	562
HAMMER BERGMANN.....	272	HEMOSTATIC CLAMP CRAFOORD.....	118	HOEN DURA DISSECTOR.....	333
HAMMER COLLIN.....	270	HEMOSTATIC CLAMP CRAFOORD-SELLORS.....	118	HOESSEL NEEDLE HOLDER.....	213
HAMMER COTTLE.....	273	HEMOSTATIC CLAMP CRAFOORD-SELLORS.....	118	HOFER RETRACTOR.....	465
HAMMER GERZOG.....	270	HEMOSTATIC CLAMP CRILE.....	107	HOFER RETRACTOR.....	465
HAMMER HAJEK.....	273	HEMOSTATIC CLAMP CRILE-RANKIN.....	107	HOFFMANN TUBING CLAMP.....	624
HAMMER HEALTH.....	273	HEMOSTATIC CLAMP DANDY.....	109	HOHMANN BONE LEVERS.....	284, 285
HAMMER KIRK.....	270	HEMOSTATIC CLAMP DEBAKEY-MOSQUITO.....	509	HOHMANN MINI.....	286
HAMMER LUCAE.....	271	HEMOSTATIC CLAMP DEBAKEY-PEAN.....	513	HOKE CHISELS.....	265
HAMMER MEAD.....	271	HEMOSTATIC CLAMP DEBAKEY-RANKIN.....	512	HOLDING ARM SYSTEM LEVLA...368, 368/1, 368/3, 368/4.....	298
HAMMER OMBREDANNE.....	273	HEMOSTATIC CLAMP DESJARDINS.....	121	HOLDING CLAMP ADSON.....	298
HAMMER PARTSCH.....	271	HEMOSTATIC CLAMP FUCHSIG.....	113	HOLLINGER OP-LARYNGOSCOPE.....	37
HAMMER QUILLING.....	271	HEMOSTATIC CLAMP GEMINI.....	115	HOLLINGER LIGHT GUIDE.....	37
HAMMER WISLING.....	271	HEMOSTATIC CLAMP GRAY.....	121	HOLLSHER NERVE HOOK.....	329
HAMORRHOID.FORCEPS MCGINNEY.....	568	HEMOSTATIC CLAMP GUYON.....	122	HOLTH RONGEUR.....	380
HAEMORRHOID LIGATORRUDD.....	568	HEMOSTATIC CLAMP HALSTED-MOSQUITO.....	105	HOLZBACH HYSTERECTOMYCLAMP.....	126
HANDLE WITH JACOBS CHUCK.....	300	HEMOSTATIC CLAMP HALSTED-MOSQUITO TITANIUM...105.....	105	HOLZBACH HYSTERECTOMYCLAMP.....	126
HANDLE ALONE.....	591	HEMOSTATIC CLAMP HARTMANN.....	104	HOLZHEIMER RETRACTOR.....	168
HANDLE FOR CHISELS/CHISELS.....	266	HEMOSTATIC CLAMP HEISS.....	112	HOOK.....	419, 475
HANDLE FOR CHISELS/OSTEO.....	266	HEMOSTATIC CLAMP JACOBSON.....	105	HOOK BALFOUR.....	193
HANDLE SCALPEL.....	38, 39, 39/1, 39/2, 40, 41	HEMOSTATIC CLAMP JOHNS-HOPKINS.....	120	HOOK BARBARA.....	419
HANDLE SCALPEL MINI.....	41	HEMOSTATIC CLAMP KANTROWITZ.....	119	HOOK DAY.....	409
HANK UTERINE DILATOR.....	580	HEMOSTATIC CLAMP KELLY.....	106	HOOK FISH.....	335
		HEMOSTATIC CLAMP KELLY-RANKIN.....	106	HOOK FORCEPS BARRET.....	582
		HEMOSTATIC CLAMP KOCHER.....	108	HOOK FORCEPS BRAUN.....	582

**Index
Indice
Indice
Verzeichnis**

HOOK FORCEPS CZERNY	584	INTERCHANGEABLE TIPS KRAUSE	472	JEWELRY TISSUE FORCEPS	90
HOOK FORCEPS DUPLAY	582	INTERCHANGEABLE TIPS LANGE	472	JOBSON-HORNVEY COTTON-APPLICATOR	203
HOOK FORCEPS HULKA	583	INTERCHANGEABLE TIPS SCHEINMANN	472	JOHNS HOPKINS APPLIER FORCEPS	104
HOOK FORCEPS IOWA	584	INTERCHANGEABLE TIPS SCHUMACHER	472	JOHNS-HOPKINS BULLDOG CLAMP	104
HOOK FORCEPS JACOBS	583	INTERCHANGEABLE TIPS SEIFERT	472	JOHNS-HOPKINS HEMOSTATIC	120
HOOK FORCEPS JARCHO	583	INTERVERTEBRAL DISC RONGEUR COLCLOUGH	344/1	JOHNSON NEEDLE HOLDER	211
HOOK FORCEPS MUSEUX	583	INTRA ORAL RETRACTORS	463/1, 463/4	JONES TOWEL CLAMP	132
HOOK FORCEPS PRATT	584	INTRAMEDULLARY PINS	322	JONES-CLIP TOWEL CLAMP	132
HOOK FORCEPS SCHRÖDER	584	INZISIONSSCISORS	52	JORGENSEN DISSECTING SCISSORS	53
HOOK FORCEPS SCHROEDER	583	IOWA HOOK FORCEPS	584	JOSEPH (LEWIS) NOSER	443
HOOK FORCEPS SCHROEDER (POZZI)	582	IOWA NEEDLE GUIDE	206	JOSEPH NOSE RASP	443
HOOK FORCEPS SKENE	582	IRIS HOOK O'CONNOR	375	JOSEPH NOSESAW	446
HOOK FORCEPS TEALE	583	IRIS HOOK WIENER	375	JOSEPH RASPATORIES	277
HOOK FORCEPSSTAUDE-MOORE	582	IRIS KNIVES DEAN	372	JOSEPH SEPTUM	437
HOOK GASS	376	IRIS KNIVES KNAPP	372	JOSEPH SEPTUM KNIVES	434
HOOK GELPI	193	IRIS KNIVES ZIEGLER	372	JOSEPH SEPTUM KNIVES	434, 435
HOOK HARRINGTON	193	IRIS SCISSORS	54	JOSEPH SKIN HOOK	149
HOOK KELLY	193	IRIS SCISSORS KNAPP	55	JOSEPH SURGICAL SCISSORS	54
HOOK KUGLEN IRIS	376	IRIS SCISSORS LITTLER	55	JUDD-ALLIS BOWEL GRASPING FORCEPS	538
HOOK LUCAE	409	IRIS SPATULA CULLER	378	JUDD-MASSON BLADDER RETRACTORS	552
HOOK MCGEE	419	IRIS SPATULA WEACKER	378	JUERS MICRO-EAR FORCEPS	414
HOOK SCOVILLE	196	IRIS SUPERCUT SCISSORS	72	JURASZ LARYNGEAL POLYPUS FORCEPS	471
HOOK SINKEY	376	IRIS TISSUE FORCEPS BARRAQUER-KATZIN	384		
HOOK SMELLIE	605	IRIS TISSUE FORCEPS BISHOP-HARMAN	386	K	
HOOK WAGENER	409	IRIS TISSUE FORCEPS BONN	387	KABIERSKJE POWDER BLOWER	405
HOOKSTEVENS	375	IRIS TISSUE FORCEPS FISCHER	384	KADER ABDOMINAL SPATULA	143/1
HOPKINS PLASTER KNIVES	233	IRIS TISSUE FORCEPS FOERSTER	383	KALLMORGEN SPECULA	573
HORIZON CLIP FORCEPS	524	IRIS TISSUE FORCEPS GILL	384	KALT CAPSULAR FORCEPS	391
HORNBY SKIN SCISSORS CASTROVIEJO	79	IRIS TISSUE FORCEPS GILL-HESS	384	KALT NEEDLE HOLDER	214
HORSLEY DURA DISSECTOR	333	IRIS TISSUE FORCEPS GRAEFE	382	KALT NEEDLE HOLDER	214
HÖSEL RETRACTOR	167	IRIS TISSUE FORCEPS HESS	384	KALT-ARRUGA NEEDLE HOLDER	615
HOUSE CURETTE	420	IRIS TISSUE FORCEPS KIRBY-ARTHUR	385	KANE NAVELSTRINGCLAMP	204
HOUSE SUCTION TUBE	337/2	IRIS TISSUE FORCEPS MODELL BONN	387	KALT-ARRUGA NEEDLE HOLDER	615
HOWARTH SEPTUM ELEVATOR	438	IRIS TISSUE FORCEPS TROUTMAN	384, 389	KANTROWITZ HEMOSTATCL	119
HUBER UNIVERSALHANDLE	472	IRIS TISSUE FORCEPS TRUBENGEN	387	KAYE FACE LIFT SCISSORS	79
HUDSON BONE HAND DRILLS	299	IRIS TISSUE FORCEPS TYPE TUEBINGEN	387	KAYSASSER OP-LARYNGOSCOP	35
HUDSON T-HANDLE	300	IRIS TISSUE FORCEPSSTEVENS	383	KEIN NEEDLE	223
HULKA HOOK FORCEPS	583	IRRIGATION CANNULA EICKEN (KILLIAN)	433	KELLY GRIP RETRACTOR	142
HUMBY DERMATOM	50	IRRIGATION CANNULA HARTMANN	433	KELLY HEMOSTATIC CLAMP	106
HUNTER SPLINTER FORCEPS	91	IRRIGATION CANNULA KILLIAN	433/1	KELLY HOOK	193
HURD TONSIL ELEVATOR	465	IRRIGATION CANNULA KILLIAN	433/1	KELLY PROCTOSCOPE	562, 635
HYPOPHYSE CURETTE	334	IRRIGATION CANNULA RITTER-HALLE	433	KELLY RETRACTOR	164
HYPOPHYSE FORCEPS	341	IRRIGATION CANNULA SIEBENMANN	433/1	KELLY UTERINE POLYP FORCEPS	585
HYPOPHYSE-TISSUE FORCEPS ADSON	334	IRRIGATION CANNULA SIMCOE	394/2	KELLY VASCULAR SCISSORS	61
HYSTERECTOMY FORCEPS WERTHEIM-CULLEN	125	IRRIGATIONCANNULA TYPE LACRIMAL	394	KELLY-RANKIN HEMOSTATIC CLAMP	106
HYSTERECTOMY SCISSORS WERTHEIM	63	ISRAEL RETRACTOR	162	KERATOPLAST-KNIVES BARRAQUER	373
HYSTERECTOMYCLAMP HEANEY	126	ITERSON TRACHEA HOOK	477	KERATOPLAST-KNIVES PAUFIQUE	373
HYSTERECTOMYCLAMP HEANEY-BALLENTINE	127	IVES-FANSLER ANOSCOPE	562	KERN BONE HOLDING FORCEPS	244
HYSTERECTOMYCLAMP ROGERS	127	MANSON MEASURING INSTRUMENT	624	KERRISON RONGEUR	428
HYSTERECTOMYCLAMP SEGOND	125			KEVORKIAN BIOPSY CURETTE	587
HYSTERECTOMYCLAMP SEGOND-LANDAU	125	J		KEVORKIAN BIOPSY FORCEPS	589, 591
HYSTERECTOMYCLAMP WERTHEIM	124	JACKSON LARYNGOSCOP	37	KEVORKIAN-PACIFIC BIOPSY FORCEPS	592
HYSTERECTOMYCLAMP WERTHEIM	128	JACKSON TENDON GRASPING FORCEPS	282	KEY ELEVATOR	282
		JACKSON TRACHEA HOOK	476	KEYES PUNCH	608
I		JACKSON VAGINAL SPECULA	573	KIDNEY CLAMP GUYON	122
I.A.D. EXTRAKTION HOOK	593	JACKSON-BURROWS RETRACTOR	189/2	KIDNEY FORCEPS HERRICK	123
I.A.D. GRASPING FORCEPS FLEXIBLE SERPENTINE	593	JACOBS HOOK FORCEPS	583	KIDNEY STONE FORCEPS HEIMING	536
ILLUMINATION ATTACHMENT	322	JACOBSON BUTTONPROBES	335	KIDNEY STONEFORCEPS RANDALL	635
IMPACTOR	322	JACOBSON CURETTE	257	KIDNEY TRAY	519
IMPACTOR/EXTRACTOR	322	JACOBSON DURA HOOK	335	KIELLAND OBSTETRICAL FORCEPS	602
IMPACTOR/EXTRAKTOR	322	JACOBSON HEMOSTATIC CLAMP	105	KIELLAND-LUIKART OBSTETRICAL FORCEPS	603
INEROSSEOUSCISORS MCINDOE	65/1	JACOBSON NEEDLE HOLDER	215	KILLIAN GOUGES	442/1
INGE LAMINA SPREADER	339	JAEGER DISCISION MESSR	372	KILLIAN NOSE SPECULA	423
INJECTION CANNULA INJECTION CANNULA	36	JAEGER LIDPLATTE	371	KILLIAN SEPTUM ELEVATO	438, 439
INSTRU-CARE INSTRUMENT OIL	634	JAMESON STRABISMUS FORCEPS	385	KILLIAN SEPTUM SCISSORS	471
INSTRUMENT BOX	617	JAMESON STRABISMUS HOOK	375	KILLIAN-CLAUS SEPTUM GOUGES	442/1
INSTRUMENT OIL INSTRU CARE	634	JANSEN BONE CURETTES	257	KILNER NEEDLE HOLDER	212
INSUFFLATIONCANNULA VERESS	206	JANSEN BONE RONGEUR	237	KILNER NOSE HOOK	447/1
INTERCHANGEABLE TIPS BARACANI	472	JANSEN EAR FORCEPS	424	KILNER SKIN HOOK	608
INTERCHANGEABLE TIPS BRIENUNGS	472	JANSEN RETRACTOR	168	KILNER SURGICAL SCISSORS	54
INTERCHANGEABLE TIPS CORDES	472	JAR	620	KILNER/RAGNELL SUPERCUT SCISSORS	72
INTERCHANGEABLE TIPS FRAENKEL	472	JARCHO HOOK FORCEPS	583	KILNER-DOUGHTY	456
INTERCHANGEABLE TIPS FRAENKEL	472	JAVID CAROTIS SHUNT CLAMP	511	KIRBY-ARTHUR IRIS FORCEPS	385
INTERCHANGEABLE TIPS FRAENKEL	472	JENNINGS MOUTH GAGS	454	KIRK HAMMER	270

**Index
Indice
Verzeichnis**

KIRSCHNER ABDOMINAL RETRACTOR.....	187, 187/1	LACHRYMAL PROBES BOWMAN.....	381	LARYNGOSCOPE WARM LIGHT HANDLE WITH TRANSFORMER CONNECTION.....	34
KIRSCHNER ABDOMINALRETRACTORS.....	185, 187	LACHRYMAL PROBES HARMIS.....	381	LATEAL VAGINAL RETRACTOR.....	569
KIRSCHNER BONE HAND DRILLS.....	299	LACRIMAL IRRIGATIONS/CANNULA.....	394	LAWRENCE HEMOSTATIC CLAMP.....	119
KIRSCHNER DRILLWIRE.....	306, 307	LAGRANGE SUPERCUT SCISSORS.....	72	LEAD HAND.....	250
KIRSCHNER GUIDEPROBES.....	221	LAHEY GRASPING FORCEPS.....	479	LEBSCHÉ CHISEL.....	267
KIRSCHNER NAIL.....	308, 309	LAHEY HEMOSTATIC CLAMP.....	120	LEES BRONCHUSCLAMP.....	504
KIRSCHNER US EXTENSION BOW.....	312	LAHEY RETRACTOR.....	149, 157	LEGUE BLADDER RETRACTORS.....	553
KLAPP RETRACTOR.....	150	LAMBERT CHALAZIO TISSUE FORCEPS.....	393	LEGUE BLADDER SPATULA.....	552
KLEINERT-KUTZ HOHLMEIB.....	237	LAMBERT-KAY AORTIC-ANASTOMOSIS CLAMP.....	505	LEKSELL(STILLE) BONE RONGEUR.....	240
KLEINERT-KUTZ SKIN HOOK.....	149	LAMBERT-LOWMAN BONE HOLDING CLAMP.....	249	LELAND-JONES VASCULARSCLAMP.....	494
KLEINERT-KUTZ TENDON GRASPING INSTRUMENT.....	294	LAMBOTTE BONE HOLDING FORCEPS.....	244	LEMPERT BONE CURETTES.....	256
KLEINSASSER CHEST SUPPORT.....	36	LAMBOTTE CHISELS.....	261	LEMPERT BONE RONGEUR.....	237
KLEINSASSER FIBERGLAS-LIGHT GUIDE.....	36	LAMBOTTE RASPATORIES.....	274, 275	LEMPERT ELEVATOR.....	420
KLEINSASSER INJECTION CANNULA.....	36	LAMINA SPREADER CLOWARD.....	339	LERCHE GRASPING TISSUE FORCEPS.....	83
KLEINSASSER SUCTION TUBE TUBE.....	36	LAMINA SPREADER INGE.....	339	LERICHE ABDOMINALSPATULA.....	143/2
KLEINSCHMIDT APPENDIXBOWEL CLAMP.....	544	LAMINECTOMY RETRACTOR CHERRY.....	488	LERICHE BOWEL SPATULA.....	143/2
KLINKENBERGH-LOTH VASCULAR SCISSORS.....	65/1	LAMINECTOMY RETRACTOR FORCEPS CLOWARD.....	342	LERICHE HEMOSTATIC CLAMP.....	111
KNAPP CATARACT CURETTE.....	378	LAMINECTOMY RETRACTOR FORCEPS OLDBERG.....	341	LESTER FIXATION FORCEPS.....	389
KNAPP EXTRACTION HOOK.....	375	LAMINECTOMY RETRACTOR FORCEPS SCHLESINGER.....	342	LEVINSON FOREIGN-BODY NEEDLE.....	374
KNAPP IRIS KNIVES.....	372	LAMINECTOMY RETRACTOR FORCEPS SPURLING.....	340	LEWIN BONE HOLDING FORCEPS.....	246
KNAPP IRIS SCISSORS.....	55	LAMINECTOMY RETRACTOR FORCEPS WAGNER.....	343	LEXER BABY DISSECTING SCISSORS.....	53
KNAPP-LUER TRACHOMA FORCEPS.....	393	LAMINECTOMY RETRACTOR FORCEPS CUSHING.....	340	LEXER CHISELS.....	263
KNIGHT SEPTUM FORCEPS.....	425	LAMINECTOMY RETRACTOR FORCEPSFERRIS-SMITH.....	343	LEXER DISSECTING SCISSORS.....	53
KNIVES AMPUTATION.....	44	LAMINECTOMY RETRACTOR FORCEPSLOVE- GRUENWALD.....	340	LEXER MINI GOUGES.....	263
KNIVES BALLENGER.....	436	LAMINECTOMY RETRACTOR SCOVILLE.....	196	LEYLA HOLDING ARM SYSTEM.....	368, 368/1, 368/3, 368/4
KNIVES BONE.....	44	LAMINECTOMY RETRACTOR SCOVILLE-HAVERFIELD.....	196	LICHTENBERG NEEDLE HOLDER.....	213
KNIVES LANGENBECK.....	47	LAMINECTOMY RETRACTOR SCOVILLE-HAVERFIELD.....	196	LICHTWITZ CANNULA.....	433
KNIVES MUCK.....	420	LANCASTER EYE SPECULA.....	371	LICHTWITZ TROCAR.....	204
KNIVES PLESTER.....	418	LANCETTE ELECTRODE MONOPOLAR.....	628, 629	LIEBERMAN EYE SPECULA.....	324
KNIVES ROSEN.....	418	LANDAU VAGINAL SPECULA.....	577	LIGATURE RINGS.....	568
KNIVES SCHUKNECHT.....	418	LANDOLT TUMOR GRASPING FORCEPS.....	341	LIGATUREE NEEDLE.....	219
KNIVES TABB.....	418	LANE BENDER.....	325	LIGATUREE NEEDLE COOPER.....	218
KNIVESWULLSTEIN.....	418	LANE BONE HOLDING FORCEPS.....	244	LIGATUREE NEEDLE DESCHAMPS.....	219
KNOWLES BANDAGE SCISSORS.....	70	LANE BONE LEVERS.....	290	LIGATUREE NEEDLE KRONECKER.....	219
KOCHER BLADDER SPATULA.....	542	LANE BONE LEVERS.....	290	LIGATUREE NEEDLE NELSON.....	219
KOCHER BOWEL CLAMP.....	540	LANE BONE LEVERS.....	290	LIGATUREE NEEDLE SCHMIEDEN-DICK.....	219
KOCHER HEMOSTATIC CLAMP.....	108	LANE BONE PLATE HOLDING FORCEPS.....	325	LIGHT GUIDE.....	37
KOCHER PROBES.....	479	LANE SCREW DRIVER.....	323, 324	LIGHT GUIDE COLD LIGHT JACKSON.....	37
KOCHER RETRACTOR.....	155, 160, 163	LANE SREWHOLDINGFORCEPS.....	325	LIGHT GUIDE HOLLINGER.....	37
KOCHER-LANGENBECK RETRACTOR.....	159	LANE STOMACH CLAMP.....	547	LIP RETRACTOR.....	453
KOENIG NEEDLE.....	223	LANE SURGICAL TISSUE FORCEPS.....	84	LISTER BANDAGE SCISSORS.....	69/1
KOERTE RETRACTOR.....	162	LANE TOWEL CLAMP.....	133	LISTER SUPERCUT SCISSORS.....	72
KOGAN ENDOSPECULA.....	577	LANE TRETOWAN BONE LEVERS.....	290	LISTER(SINUS) DRESSING FORCEPS.....	137
KÖNIG BONE LEVERS.....	284	LANG EXTRACTION DISSECTOR.....	378	LISTER-BURCH EYE SPECULA.....	370
KÖNIG GUIDEPROBES.....	221	LANGE INTERCHANGEABLE TIPS.....	472	LITSON AMPUTATION KNIVES.....	44
KÖNIG RASPATORIES.....	276	LANGE NOSE HOOK.....	448	LITSON BONE CUTTING FORCEPS.....	241
KÖNIG RETRACTOR.....	153	LANGE-HOHMANN.....	286	LITTAUER CILIA FORCEPS.....	395
KOOS DURA KNIVES.....	335	LANGENBECK FINGER PROTCTOR.....	311	LITTAUER EAR FORCEPS.....	411
KOPFSCHWARTENFORCEPS GAUSS.....	605	LANGENBECK AMPUTATION KNIVES.....	44	LITTAUER POLYP FORCEPS.....	425
KRAUSE INTERCHANGEABLE TIPS.....	472	LANGENBECK BONE HOLDING FORCEPS.....	243	LITTAUER SUTURESCISSORS.....	66
KRAUSE POLYP SMARE.....	433/2	LANGENBECK EAR LOOP.....	409	LITTLE RETRACTOR.....	157
KRAUSE POLYP SMARE.....	411, 434	LANGENBECK FINGER SAW.....	296	LITTLER IRIS SCISSORS.....	55
KRAUSE-VOSS POLYP SMARE.....	433/2	LANGENBECK KNIVES.....	47	LITTLEWOOD BOWEL GRASPING FORCEPS.....	538
KRAYENBÜHL NERVE HOOK.....	336	LANGENBECK NEEDLE HOLDER.....	213	LOCKHART-MUMMEY FISTULAPROBES.....	200
KRISTELLER SPECULA.....	572	LANGENBECK RASPATORIES.....	275	LOCKLIN GUM SCISSORS.....	69
KRISTELLER VAGINAL SPECULA.....	572	LANGENBECK RETRACTOR.....	158, 159	LOCKWOOD-ALLIS BOWEL GRASPING FORCEPS.....	538
KRÖNIG TONGUE DEPRESSORS.....	451	LANGENBECK-GREEN RETRACTOR.....	153	LONDON-COLLEGE TEETH TISSUE FORCEPS.....	93
KRONECKER LIGATUREE NEEDLE.....	219	LARSEN TENDON GRASPING FORCEPS.....	292	LOOP ELECTRODE MONOPOLAR.....	628, 629
KUGLEN HOOK.....	376	LARYNGEAL CANNULA WIE.....	470	LOPEZ-REINKE TONSIL.....	465
KUHNT CORNEAL SCLEROTOME.....	373	LARYNGEAL MIRROR.....	423	LORENZ BANDAGE SCISSORS.....	70
KÜMMEL ABDOMINAL- A. BOWEL SPATULA.....	143/2, 144	LARYNGEAL MIRROR MICHEL.....	473	LORNA TOWEL CLAMP.....	133
KÜNTSCHER DRIVER.....	321	LARYNGEAL POLYPUS FORCEPS FRAENKEL.....	471	LOUTE WIRE INSTRUMENT.....	315
KÜNTSCHER EXTRACTOR.....	322	LARYNGEAL POLYPUS FORCEPS JURASZ.....	471	LOVE NERVE HOOK.....	329, 330
KÜNTSCHER REAMER.....	321	LARYNGOSCOPE COLD LIGHHANDLE BATTERY HANDLE.....	33	LOVE RETRACTOR.....	465
L.....		LARYNGOSCOPE FOREGGER.....	29, 31	LOVE-GRUENWALD.....	340
LA FORCE ADENOID CURETTE.....	450	LARYNGOSCOPE HOLLINGER.....	37	LOVELACE HEMOSTATIC CLAMP.....	109
LA FORCE FOREIGN-BODY NEEDLE.....	374	LARYNGOSCOPE JACKSON.....	37	LOVELACE LUNG GRASPING FORCEPS.....	490
LA GRANGE GUM SCISSORS.....	69	LARYNGOSCOPE MCINTOSH.....	29, 31	LOWER HEMOSTATIC CLAMP.....	120
LABORDE TRACHEA DILATOR.....	476	LARYNGOSCOPE MILLER.....	30	LOWMAN BONE HOLDING CLAMP.....	249
LACHRYMAL DILAT. WILDER.....	381	LARYNGOSCOPE WARM LIGHT BATTERY HANDLE.....	32	LOWMAN-HOGLUND BONE HOLDING CLAMP.....	249
LACHRYMAL DILAT.CASTROVIEJO.....	381			LUBET-BARBON NOSE DRESSING FORCEPS.....	424
LACHRYMAL DILATOR ZIEGLER.....	381			LUC SEPTUM FORCEPS.....	426

**Index
Indice
Indice
Verzeichnis**

LUCAE EAR FORCEPS.....	410	MGEE MICRO-EAR FORCEPS.....	414	MIKULICZ PERITONEUMCLAMP.....	123
LUCAE HAMMER.....	271	MCINDOE INEROSSEUSSCISSORS.....	65/1	MIKULICZ RETRACTOR.....	163
LUCAE HOOK.....	409	MCINDOE TISSUE FORCEPS.....	85	MIKULICZ-BABY PERITONEUMCLAMP.....	123
LUCAE PARACENTESIS NEEDLE.....	408	MCINTOSH LARYNGOSCOP.....	29, 31	MILLER LARYNGOSCOP.....	30
LUCAE TUNING FORC.....	404	MCINTYRE EYE CANNULA.....	394	MILLER NOSE RASP.....	444
LUER BONE RONGEUR.....	236	MCIVOR MOUTH GAGS.....	457	MILLIGAN DURA DISSECTOR.....	332
LUER RETRACTOR.....	140	MCKENTY SEPTUM ELEVATOR.....	437, 438	MILLIN BLADDER RETRACTORS.....	552
LUER TRACHEA CANNULA.....	479	MCKENZIE APPLIERFORCEPS.....	326	MILLIN BLADDER SPREADER.....	553
LUER-KOERTE GALL STONE CURETTE.....	533	MCLEAN OBSTETRICAL FORCEPS.....	603	MILLIN CAPSULAR GRASPING FORCEPS.....	551
LUKART OBSTETRICAL FORCEPS.....	603	MCLEAN-LUIKART OBSTETRICAL FORCEPS.....	603	MILLIN PROSTATIC GRASPING FORCEPS.....	551
LUNDGAARD SKLEROTOM.....	373	MCLEAN-TUCKER-LUIKART OBSTETRICAL FORCEPS.....	603	MINI BULLDOG CLAMP DEBAKEY-DIETHRICH.....	101
LUNG GRASPING FORCEPS LOVELACE.....	490	MCPHERSON TISSUE FORCEPS.....	392	MINI QUICK HANDLE.....	301
LUNG SCISSORS CRAFOORD.....	65/2	MEAD BONE RONGEUR.....	235	MINI SCALPEL.....	41
LUNG SPATULA ALLISON.....	489	MEAD HAMMER.....	271	MINI SCALPEL HANDLE.....	41
LUNIATSCHEK ELEVATOR.....	465	MEASURANCE CIRCLE CASTROVIEJO.....	380	MINI-BULLDOG CLAMP.....	101
LUPUS CURETTE FOX.....	608	MEASURING INSTRUMENT.....	594	MINI-LAMBOTTE CHISELS.....	262
LUPUS CURETTE PIFFARD.....	608	MEASURING INSTRUMENT.....	594	MINIMUS SPHYGMOMANOMETER.....	11, 12
		MEASURING INSTRUMENT IWANSON.....	624	MINI-TOWNSEND-DOWN BIOPSY FORCEPS.....	591
M		MEASURING RULE.....	25	MINI-TOWNSEND-UP BIOPSY FORCEPS.....	591
MAGILL CATETHER INTRODUCING FORCEPS.....	28	MEDICINE CUP.....	621	MIXTER GALL STONE FORCEPS.....	531
MAIER DRESSINGFORCEPS.....	134	MEDICINE SPOON.....	621	MIXTER HEMOSTATIC CLAMP.....	116, 119, 120, 121
MALTZ (COTTLE) NOSE RASP.....	444	MEEKER HEMOSTATIC CLAMP.....	119	MIXTER HEMOSTATIC CLAMP S-CVD.....	116
MALTZ NOSE RASP.....	443	MEHDORN APPLIER FORCEPS.....	362	MIXTER-BABY HEMOSTATIC CLAMP.....	119
MANDIBULAR BODY RETRACTOR HARGIS.....	463/6	MEHDORN VASCULAR CLIP.....	362	MIXTER-O-SHAUGNESSY.....	120
MANDRIN FOR TOURNIQUET.....	528	MELLINGER EYE SPECULA.....	370	MIXTER-O-SHAUGNESSY HEMOSTATIC CLAMP.....	120
MANOMETER.....	295, 596	MELLINGER-AXENFELD EYE SPECULA.....	370	MODELL BONN IRIS TISSUE FORCEPS.....	387
MARKERSCONNIN-AMSLER.....	380	MENGHINI BIOPSY NEEDLE.....	206	MOELTGEN GONIOMETER.....	25
MARQUARD BONE RONGEUR.....	239	MENISCUSHOOK BLOUNT.....	289	MOGEN CIRCUMCISION INSTRUMENT.....	556
MARSCHIK TONSIL FORCEPS.....	468	MENISCUSKNIVES NEFF.....	292	MOLLISON RETRACTORS.....	176
MARTEL GRASPING FORCEPS.....	110	MENISCUSKNIVES SMILLIE.....	292	MOLT RESPIRATORIESUM.....	271
MARTIN BONE HOLDING FORCEPS.....	246	MERCEDES THORACIC SPREADER.....	489	MONOPOLAR ELECTRODE BALL.....	628, 629
MARTIN CARTILAGE SCISSORS.....	65/1	MERIAM TEETH TISSUE FORCEPS.....	93	MONOPOLAR ELECTRODE LANCETTE.....	628, 629
MARTIN PELVIMETER.....	605	METAL CATHETER.....	555	MONOPOLAR ELECTRODE LOOP.....	628, 629
MARTIN RETRACTOR.....	175/1	METAL CATHETER COXETER.....	555	MONOPOLAR ELECTRODE NEEDLE.....	628, 629
MARTIN UTERINE-PROBES.....	586	METZENBAUM 'S' SURGICAL SCISSORS.....	54	MOOR GALL STONE CURETTE.....	532
MARTINI BONE CURETTES.....	257	METZENBAUM DISSECTING SCISSORS.....	53/1	MOORE BONE HAND DRILLS.....	298
MASSING-NEVERT NOSE HOOK.....	447/1	METZENBAUM FINO TO DISSECTING SCISSORS.....	53/1	MOORFIELD TISSUE FORCEPS.....	392
MASSON NEEDLE HOLDER.....	210	METZENBAUM NEEDLE HOLDER.....	211	MORGAN PROCTOSCOPE.....	565
MASTIN MUSCLE CLAMP.....	479	METZENBAUM SUPERCUT SCISSORS.....	71	MORITZ-SCHMIDT TONGUE DEPRESSORS.....	452
MATHIEU FOREIGN-BODY FORCEPS.....	553/1	METZENBAUM TO DISSECTING SCISSORS.....	53/1	MORRIS RETRACTOR.....	164
MATHIEU NEEDLE HOLDER.....	213	MEYERDING RETRACTOR.....	150	MORRIS-DEBAKEY AORTIC CLAMP.....	506
MATHIEU RECTAL SPECULA.....	560	MEYERDING RETRACTORS.....	180	MORSE RIB SPREADER.....	484
MATHIEU RETRACTOR.....	141	MEYHOEFER CHALAZIO CURETTE.....	377	MORSE-FAVALORO RIB SPREADER.....	484
MATHIEU-OLSEN NEEDLE HOLDER.....	212	MICHEL CLIP.....	224	MOUTH GAGS DAVIS-BOYLE.....	455
MATSON RASPARTORIES.....	279	MICHEL CLIP FORCEPS.....	224	MOUTH GAGS DENHART.....	454
MATSON-ALEXANDER RASPARTORIES.....	279	MICHEL CLIP TISSUE FORCEPS.....	224	MOUTH GAGS DINGMANN.....	456
MAXI GRASPER BIOPSY FORCEPS.....	593	MICHEL LARYNGEAL MIRROR.....	423	MOUTH GAGS HEISTER.....	454
MAYFIELD BONE RONGEUR.....	238	MICRO FRIEDMANN.....	234	MOUTH GAGS JENNINGS.....	454
MAYO DISSECTING SCISSORS.....	52	MICRO FRIEDMANN BONE RONGEUR.....	234	MOUTH GAGS MCIVOR.....	457
MAYO GALL STONE CURETTE.....	534	MICRO SICKLE KNIVES.....	475	MOUTH GAGS ROSER-KOENIG.....	454
MAYO GALL STONE PROBES.....	534	MICRO-CURETTE FORCEPS WULLSTEIN.....	416	MOUTH GAGSDOYEN-JANSEN(MOLT).....	454
MAYO STERILIZATION CLAMP.....	227	MICRO-EAR FORCEPS.....	413	MOYNIHAN GALL STONE PROBES.....	532
MAYO SUPERCUT SCISSORS.....	71	MICRO-EAR FORCEPS COS.....	414	MOYNIHAN HEMOSTATIC CLAMP.....	123
MAYO TISSUE FORCEPS.....	89	MICRO-EAR FORCEPS DIETER.....	414	MOYNIHAN TOWEL CLAMP.....	131
MAYO TONGUE DEPRESSORS.....	451	MICRO-EAR FORCEPS GREVEN.....	414	MUCK KNIVES.....	420
MAYO-ADAMS RETRACTORS.....	171	MICRO-EAR FORCEPS HAUGH.....	414	MUELLER EYE SPECULA.....	371
MAYO-BLAKE GALL STONE FORCEPS.....	531	MICRO-EAR FORCEPS JUERS.....	414	MULLER APPROXIMATOR.....	364
MAYO-COLLINS RETRACTOR.....	141	MICRO-EAR FORCEPS MCGEE.....	414	MULLER VASCULAR CLIP.....	365
MAYO-COLLINS RETRACTOR-SET.....	141	MICRO-EAR SCISSORS BELLUCCI.....	413	MURDOCK EYE SPECULA.....	370
MAYO-GUYON HEMOSTATIC CLAMP.....	319	MICRO-EAR SCISSORS SHEA.....	413	MURPHY RETRACTOR.....	156
MAYO-HEGAR NEEDLE HOLDER.....	209	MICRO-GRASPING FORCEPSREARSCHAFT.....	415	MURPHY-LANE ELEVATOR.....	283
MAYON-GUYON HEMOSTATIC CLAMP.....	122	MICRO-HARTMANN HEMOSTATIC CLAMP.....	104	MUSCLE CLAMP MASTIN.....	479
MAYO-NOBLE DISSECTING SCISSORS.....	52	MICRO-SCISSORS.....	76, 77, 78, 80	MUSCLE FORCEPS PRINCE.....	387
MAY-OPHTHALMOSKOP UNI.....	14	MICRO-SCISSORS GOMEL.....	80	MUSCLEHOOK.....	267
MAYO-ROBSON BOWEL CLAMP.....	541	MICRO-SCISSORS HEPP-SCHEIDEL.....	78	MUSCLEHOOK GREEN.....	375
MAYO-STILLE DISSECTING SCISSORS.....	52	MICRO-SCISSORS REDA.....	77, 78, 80	MUSCULE FORCEPS BERKE.....	389
MAYO-STILLE SUPERCUT SCISSORS.....	71	MICRO-SCISSORSBELLUCCI.....	417	MUSEUX HOOK FORCEPS.....	583
MC DONALD ELEVATOR.....	283	MICROSURGICAL TISSUE FORCEPS.....	94	MYLES NOSE FORCEPS.....	427
MC GIVNEY HAEMORRHOIDAL LIGATOR.....	568	MICROSURGICAL TISSUE FORCEPS GOMEL.....	96	MYOMA A SCREW DOYEN.....	594
MC INDOE BONE CUTTING FORCEPS.....	241	MICROVASCULAR NEEDLE HOLDER.....	210	MYOMA KNIVES SEGOND.....	594
MC KENZIE DRILL.....	299	MIDDELDRORP RETRACTOR.....	160		
MCCULLOUGH STRABISMUS FORCEPS.....	385	MIDDLETON-JANSEN SEPTUM FORCEPS.....	430		
MCGEE HOOK.....	419	MIKULICZ BOWEL CLAMP.....	543		

**Index
Indice
Index
Verzeichnis**

N			
NABATOFF VARICOSE VEIN PROBES.....	201	NEEDLE YOUNG-BOOMERANG.....	220
NAEGELE OBSTETRICAL FORCEPS.....	602	NEFF MENISCUS KNIVES.....	292
NAGER RETRACTOR.....	465	NEGUS CHEST SUPPORT.....	459
NAGER TONSIL NEEDLE.....	466	NEIVERT NEEDLE HOLDER.....	208
NAIL BRUSHES.....	611	NEIVERT-ANDERSON CHISEL.....	442
NAIL DRILL.....	297	NELATON PROBES.....	199
NAIL FORCEPS.....	609, 613	NELSON LIGATUREE NEEDLE.....	219
NAIL FORCEPS ANVIL.....	613	NELSON STANDARD TROCAR.....	204
NAIL FORCEPS RADOLF.....	297	NELSON TROCAR.....	205
NAIL FORCEPS TURNBULL.....	609	NELSON VASCULARTISSEE FORCEPS.....	89
NAIL IMPACTOR.....	322	NEONATAL VASCULAR CLAMP.....	523
NAIL NIPPERS.....	612/2, 613, 614	NEONATAL VASCULAR CLAMP CASTANEDA.....	527
NAIL RASP.....	610	NERVE ENHOOK CUSHING.....	328
NAIL SCISSORS.....	609	NERVE HOOK CRILE.....	328
NAIL SET.....	609	NERVE HOOK DANDY.....	328
NAIL SKIN FORCEPS.....	613	NERVE HOOK GRAHAM.....	328
NAIL SKIN FORCEPS.....	610, 613	NERVE HOOK HOLSHER.....	329
NAIL SPLITTING SCISSORS.....	614	NERVE HOOK KRAYENBUEHL.....	336
NAVELSTRINGCLAMP COLLIN.....	605	NERVE HOOK LOVE.....	329
NAVELSTRINGCLAMP KANE.....	605	NERVE HOOK LOVE.....	330
NEEDLE.....	222, 223	NERVE HOOK SACHS.....	328
NEEDLE BARBARA.....	419	NERVE HOOK SCOVILLE.....	329, 330
NEEDLE ELECTRODE MONOPOLAR.....	628, 629	NERVE HOOK SMITHWICK.....	328
NEEDLE GUIDE IOWA.....	206	NEUGS TONSIL FORCEPS.....	467
NEEDLE HOLDER ADSON.....	211	NEUROSURGICAL SCISSOR STRULLY.....	85
NEEDLE HOLDER ARRUGA.....	214	NEUROSURGICAL SCISSORS.....	85
NEEDLE HOLDER BABY-OLSEN-HEG.....	212	NEWS TRACHEA HOOK.....	477
NEEDLE HOLDER BABY-WEBSTER.....	208	NIPPERS NAIL.....	612/2, 613, 614
NEEDLE HOLDER BARBAQUER.....	217	NISSEN FINE HEMOSTATIC CLAMP.....	113
NEEDLE HOLDER BARBAQUER MICRO.....	216	NISSEN HEMOSTATIC CLAMP.....	113
NEEDLE HOLDER BAUMGARTNER.....	208	NOISE APPARTUS POLITZER.....	405
NEEDLE HOLDER BOYNTON.....	214	NORDFOLK-NORWICH RETRACTORS.....	172
NEEDLE HOLDER BOZEMANN.....	211	NORTHBENT SUTURE SCISSORS.....	66
NEEDLE HOLDER BROWN.....	209	NOSE DRESSING FORCEPS LUBET-BARBON.....	424
NEEDLE HOLDER CASTROVIEJO.....	215	NOSE DRESSING FORCEPS WESTMACCOTT.....	424
NEEDLE HOLDER CASTROVIEJO.....	216	NOSE FORCEPS CAPLAN.....	428
NEEDLE HOLDER CASTROVIEJO MICRO.....	215	NOSE FORCEPS HARLMANN.....	427
NEEDLE HOLDER CHEEKSTEEN.....	210	NOSE FORCEPS MYLLES.....	427
NEEDLE HOLDER COLLIER125CM.....	208	NOSE FORCEPS SCHMEDEN.....	427
NEEDLE HOLDER CRILE.....	213	NOSE FORCEPS TAKAHASHI.....	427
NEEDLE HOLDER CRILE-MURRAY.....	209	NOSE FORCEPS WATSON-WILLIAMS.....	428
NEEDLE HOLDER CRILE-WOOD TC.....	209	NOSE FORCEPS WEIL-BLAKESLEY.....	426
NEEDLE HOLDER DE BAKEY.....	210	NOSE FORCEPSSTRUYCKEN.....	427
NEEDLE HOLDER DERF.....	208	NOSE HOOK AUFRICHT.....	447
NEEDLE HOLDER FINOCCHIETTO.....	211	NOSE HOOK CONVERSE.....	448
NEEDLE HOLDER GILLIES.....	212	NOSE HOOK COTTLE.....	447, 447/1
NEEDLE HOLDER HALSEY.....	208	NOSE HOOK HOOK.....	447
NEEDLE HOLDER HALSEY.....	208	NOSE HOOK LANGE.....	448
NEEDLE HOLDER HEANEY.....	210	NOSE HOOK MASING-NEIVERT.....	447
NEEDLE HOLDER HOESSEL.....	213	NOSE RASP FOMON.....	444, 445
NEEDLE HOLDER JOACOBSON.....	215	NOSE RASP JOSEPH.....	443
NEEDLE HOLDER JOHNSON.....	211	NOSE RASP JOSEPH (LEWIS).....	443
NEEDLE HOLDER KALT-ARRUGA.....	214	NOSE RASP MALTZ.....	443
NEEDLE HOLDER KILNER.....	212	NOSE RASP MALTZ (COTTLE).....	444
NEEDLE HOLDER LANGENBECK.....	213	NOSE RASP MILLER.....	444
NEEDLE HOLDER LICHTENBERG.....	213	NOSE RASP PEET.....	446
NEEDLE HOLDER MASSON.....	210	NOSE RASP WIENER.....	443
NEEDLE HOLDER MATHIEU.....	213	NOSE SCISSORS.....	429
NEEDLE HOLDER MATHIEU-OLSEN.....	212	NOSE SCISSORS COTTLE.....	59
NEEDLE HOLDER MAYO-HEGAR.....	209	NOSE SCISSORS FOMON.....	58
NEEDLE HOLDER METZENBAUM.....	211	NOSE SCISSORS HEYMANN.....	58
NEEDLE HOLDER MICROVASCULAR.....	210	NOSE SPECULA COTTLE.....	423
NEEDLE HOLDER NEIVERT.....	208	NOSE SPECULA HARTMANN.....	422
NEEDLE HOLDER OLSEN-HEGAR.....	212	NOSE SPECULA HARTMANN-HALLE.....	421
NEEDLE HOLDER RYDER.....	210	NOSE SPECULA KILLIAN.....	423
NEEDLE HOLDER SAROT.....	211	NOSE SPECULA REDA.....	423
NEEDLE HOLDER STEVENS.....	214	NOSE SPECULA THUDICHUM.....	423
NEEDLE HOLDER STRATTE.....	212	NOSE SPECULA TIECK-HALLE.....	423
NEEDLE HOLDER WEBSTER.....	208	NOSE SPECULA TYPE VIENNA.....	421
NEEDLE REVERDIN.....	220	NOSE SPECULA VOLTOLINI.....	421
NEEDLE ROSEN.....	419	NOSEOLIVE POLITZER.....	406
NEEDLE STERILIZATION CASE.....	615	NOSESAW JOSEPH.....	446
		NOTO UTERINE POLYP FORCEPS.....	585
		NOVA SPHYGMOMANOMETER.....	6, 7
		NOVAK BIOPSY CURETTE.....	587
		NOYES EYESCISSORS.....	75
		NOYES POLYP FORCEPS.....	425
		NOYES ROTATOR BECHERT.....	379
		NUSTAGMUS SPECTACLES FRENZEL.....	20
		O	
		OBDUKTIONS-BESTECK.....	269
		OBSTETRICAL CURETTE SELLHEIM.....	607
		OBSTETRICAL FORCEPS BARTON.....	603
		OBSTETRICAL FORCEPS BOERMA.....	604
		OBSTETRICAL FORCEPS DE LEE.....	602
		OBSTETRICAL FORCEPS ELLIOT.....	602
		OBSTETRICAL FORCEPS KIELLAND.....	602
		OBSTETRICAL FORCEPS KIELLAND-LUIKART.....	603
		OBSTETRICAL FORCEPS LUIKART.....	603
		OBSTETRICAL FORCEPS MCLEAN.....	603
		OBSTETRICAL FORCEPS MCLEAN-LUIKART.....	603
		OBSTETRICAL FORCEPS MCLEAN-TUCKER.....	603
		OBSTETRICAL FORCEPS MCLEAN-TUCKER-LUIKART.....	603
		OBSTETRICAL FORCEPS NAEGELE.....	602
		OBSTETRICAL FORCEPS PIPER.....	604
		OBSTETRICAL FORCEPS SIMPSON.....	602
		OBSTETRICAL FORCEPS SIMPSON-BRAUN.....	603
		OBSTETRICAL FORCEPS SIMPSON-LUIKART.....	603
		OBSTETRICAL FORCEPS WRIGLEY.....	602
		OBWEGESER AHLE.....	463
		OBWEGESER BLADE OSTEOTOME.....	464/1
		OBWEGESER RASPARTORIES.....	462
		OBWEGESER RETRACTOR.....	460, 461
		OBWEGESER RETRACTORS.....	463
		OCHSNER TROCAR.....	205
		O'CONNOR IRIS HOOK.....	375
		OELHER SURGICAL TISSUE FORCEPS.....	811
		OLDBERG LAMINECTOMY RETRACTOR FORCEPS.....	341
		OLIVECRONA BONE RONGEUR.....	237
		OLIVECRONA BRAINSPATULA.....	336
		OLIVECRONA DURA DISSECTOR.....	332
		OLIVECRONA WIRESAW.....	332
		OLIVECRONA-TOENNIS (SCOVILLE).....	326
		OLIVECRONA-TOENNIS APPLIERSFORCEPS.....	326
		OLLIER RETRACTOR.....	162
		OLSEN-HEGAR NEEDLE HOLDER.....	212
		OMBREDANNE HAMMER.....	273
		OPHTHALMOSKOP MAY UNI II.....	14
		OP-LARYNGOSKOP HOLLINGER.....	37
		OP-LARYNGOSKOP JACKSON.....	37
		OP-LARYNGOSKOP KLEINSASSER.....	35
		OPHTHALMOLOGIC SCISSORS.....	57, 58
		OPHTHALMOLOGIC SCISSORS AEBLI.....	58
		OPHTHALMOLOGIC SCISSORS GRADLE.....	57
		OPHTHALMOLOGIC SCISSORSSTEVENS.....	58
		OSCILLATION PLASTER CAST SAW.....	230
		OSTEOTOME BLADE OBWEGESER.....	464/1
		OSTEOTOME EPKER.....	464/2
		OSTROEM ANTRUM-PUNCH.....	430
		O'SULLIVAN-O'CONNOR ABDOMINALDECKEN.....	181
		O'SULLIVAN-O'CONNOR ABDOMINALRETRACTORS.....	181
		O'SULLIVAN-O'CONNOR SP.....	576
		OTIS URETHROTOME.....	553
		OTOSKOPE DIAGNOSTIC SET UNI I.....	13
		OVAL RING.....	194
		OVERHOLT HEMOSTATIC CLAMP.....	114
		OVERHOLT-BABY HEMOSTATIC CLAMP.....	114
		OVERHOLT-GEISENDOERFER HEMOSTATIC CLAMP.....	114
		OVERHOLT-MIXER HEMOSTATIC CLAMP.....	115
		OVUM CURETTE CUZZI.....	606
		OVUM CURETTE PESTALOZZA.....	606
		OVUM CURETTE WALLICH.....	607
		OVUM FORCEPS SAENGER.....	606
		OVUM FORCEPS WINTER.....	606

**Index
Indice
Index
Verzeichnis**

REDA SICKLE KNIVES.....	435	RETRACTOR MORRIS.....	164	RIB SPREADER HAIGHT.....	487
REDA SKIN HOOK.....	150	RETRACTOR MURPHY.....	156	RIB SPREADER MORSE.....	484
REDA STERILIZATIONFORCEPS.....	615	RETRACTOR NAGER.....	465	RIB SPREADER MORSE-FAVALORO.....	484
REDA SUTUREFORC.....	221	RETRACTOR OBWEGESER.....	460, 461	RIB SPREADER RIENHOFF-FINOCHIETTO.....	486
REDON GUIDE NEEDLE.....	207	RETRACTOR OLLIER.....	162	RIB SPREADER TUFFIER.....	487
REES FACE LIFT SCISSORS.....	73	RETRACTOR PARKER.....	139	RIB SPREADERBAILEY-GIBBON.....	489
REICHERT DECKEL EPIGLOTTIS RETRACTOR.....	471	RETRACTOR RAGNELL.....	140	RIBBON BOWEL SPATULA.....	143
REILL BONE HOLDING FORCEPS.....	248	RETRACTOR RAMIUS.....	461	RICARD ABDOMINALRETRACTORS.....	191
REINER EAR SYRINGE.....	406	RETRACTOR RICHARDSON.....	142	RICHARDSON RETRACTOR.....	142
REINER PLASTER KNIVES.....	233	RETRACTOR RICHARDSON GRIP.....	142	RICHARDSON-EASTMAN RETRACTOR.....	142
REKORDSYRINGE.....	596	RETRACTOR RICHARDSON-EASTMAN.....	142	RICHARDSON-GRIP RETRACTOR.....	142
RESANO BOWEL CLAMP.....	542	RETRACTOR ROSE.....	140	RICHNAU-HOLMGREN EAR SPECULA.....	400
RESANO CAPSULA SCISSORS.....	53/2	RETRACTOR ROUX.....	139	RICHTER-HEATH CLIP FORCEPS.....	224
RESECTION KNIVES.....	47	RETRACTOR ROUX-BABY.....	140	RIENHOFF-FINOCHIETTO RIB SPREADER.....	486
RETRACTOR ALM.....	168	RETRACTOR ROUX-MINI.....	140	RIGBY ABDOMINALRETRACTORS.....	189/2
RETRACTOR ANDERSON.....	198	RETRACTOR SAUERBRUCH.....	164	RI-MINI DIAGNOSTIC SET.....	17
RETRACTOR ASSEMBLY.....	188	RETRACTOR SAUERBRUCH.....	164, 166	RING OVAL.....	194
RETRACTOR AUFRANC.....	289	RETRACTOR SENN-GREEN.....	153	RING ROUND.....	194
RETRACTOR BREAST.....	198	RETRACTOR SENN-MILLER.....	143	RING SEGMENT.....	194
RETRACTOR BRUNNER.....	167	RETRACTOR SIMON.....	164	RING TONGUE DEPRESSORS.....	455
RETRACTOR COLLIN.....	139	RETRACTOR SPINA-NASALIS.....	461	RINGS LIGATURE.....	568
RETRACTOR COLLIN HARTMANN.....	141	RETRACTOR TEBBETTS.....	197	RITTER-HALLE IRRIGATION CANNULA.....	433
RETRACTOR COOLEY.....	148	RETRACTOR TESSIER.....	463/3	ROBB SPATULA.....	530
RETRACTOR CORONAL BROW.....	198	RETRACTOR TUFFIER.....	147	ROBERTS HEMOSTATIC CLAMP.....	117
RETRACTOR CORYLLOS.....	166	RETRACTOR US-ARMY PARKER-LANG.....	141	ROCHARD ABDOMINAL RETRACTORS.....	186
RETRACTOR CRALE.....	140	RETRACTOR VOLKMANN.....	153	ROCHESTER-CARMALT HEMOSTATIC CLAMP.....	109
RETRACTOR CUSHING.....	151	RETRACTOR VOLKMANN.....	156	ROCHESTER-OCHSNER HEMOSTATIC CLAMP.....	108
RETRACTOR DAVIDSON (SCAPULA).....	166	RETRACTOR YANOSKIE.....	198	ROCHESTER-PEAN HEMOSTATIC CLAMP.....	108
RETRACTOR DEAEVER.....	145	RETRACTOR ZENKER.....	161	ROEDER TOWEL CLAMP.....	132
RETRACTOR DEAEVER GRIP.....	146	RETRACTORS ADSON.....	173	ROGER SEPTUM.....	437
RETRACTOR DEBAKEY.....	189/1	RETRACTORS ADSON.....	172, 173, 174	ROGERS HYSTERECTOMYCLAMP.....	127
RETRACTOR DELEE.....	574	RETRACTORS ANDERSON-ADSON.....	172	ROGGE STERILIZATION FORCEPS.....	227
RETRACTOR DESMARRÉS.....	151	RETRACTORS BECKMANN.....	176	ROLLET EXTRACTION CHISELS.....	374
RETRACTOR DESMARRÉS.....	151	RETRACTORS BECKMANN-ADSON.....	175	ROLLET EXTRACTION HOOK.....	375
RETRACTOR DOYEN.....	163	RETRACTORS BECKMANN-EATON.....	176	RONGEUR CITELLI.....	430
RETRACTOR DOYEN-STILLE.....	167	RETRACTORS CASPAR.....	179, 180	RONGEUR FERRIS-SMITH-KERRISON.....	344, 344/2
RETRACTOR FAREBEUF.....	139	RETRACTORS CLOWARD.....	178	RONGEUR HAJEK-KOFLER.....	429, 431
RETRACTOR FERRIERA.....	197	RETRACTORS DARLING.....	178	RONGEUR HOLTH.....	380
RETRACTOR FINSEN.....	168	RETRACTORS HEINLEY.....	170	RONGEUR KERRISON.....	428
RETRACTOR FREEMAN.....	198	RETRACTORS MAYO-ADAMS.....	171	ROSE RETRACTOR.....	140
RETRACTOR FRITSCH.....	163	RETRACTORS MEYERDING.....	180	ROSEN KNIVES.....	418
RETRACTOR GIL-VERNET.....	152	RETRACTORS MOLLISON.....	171	ROSEN NEEDLE.....	419
RETRACTOR GOELET.....	141	RETRACTORS NORDFOLK-NORDWICH.....	172	ROSEN SUCTION TUBE.....	338
RETRACTOR GREEN.....	160	RETRACTORS PERKINS.....	168	ROSER-KOENIG.....	454
RETRACTOR HARRINGTON.....	147	RETRACTORS PLESTER.....	171	ROUND RING MEDIUM.....	194
RETRACTOR HARRINGTON-PEMBERTON.....	147	RETRACTORS PLESTER.....	171	ROUX MINI RETRACTOR.....	140
RETRACTOR HEANEY.....	164	RETRACTORS PLESTER.....	171	ROUX RETRACTOR.....	139
RETRACTOR HIBBES.....	164	RETRACTORS SCALP-CONTOUR.....	169	ROUX-BABY RETRACTOR.....	140
RETRACTOR HOESSEL.....	167	RETRACTORS TRAVERS.....	172	ROWE.....	459
RETRACTOR HOFER.....	465	RETRACTORS WEITLANER.....	169	RUBIN SEPTUM FORCEPS.....	428
RETRACTOR HOLZHEIMER.....	168	RETRACTORS WULLSTEIN.....	171	RUDD HAEMORRHOIDAL LIGATOR.....	568
RETRACTOR ISRAEL.....	162	RETRACTOR PERCY.....	296	RUMEL HEMOSTATIC CLAMP.....	117
RETRACTOR JACKSON-BURROWS RETRACTOR.....	189/2	REVERDIN BOWEL SPATULA.....	143/1	RUMEL-BELMONT TOURNIQUET.....	528
RETRACTOR JANSEN.....	168	REVERDIN NEEDLE.....	220	RUSKIN BONE RONGEUR.....	239
RETRACTOR KELLY.....	164	REYNOLDS SUPERCUT SCISSORS.....	72	RUSKIN-LISTON BONE CUTTING FORCEPS.....	241
RETRACTOR KELLY GRIP.....	142	REYNOLDS SURGICAL SCISSORS.....	54	RUSS MODELL GRASPING TISSUE FORCEPS.....	85
RETRACTOR KLAPP.....	150	RHINOPLASTIKSCISSORS FOMON.....	65/1	RUSSEL-DAVIS.....	458
RETRACTOR KOCHER.....	155	RIB SCISSORS.....	480	RYDEL-SEIFFERT TUNING FORC.....	404
RETRACTOR KOCHER.....	160, 163	RIB SCISSORS BETHUNE.....	481	RYDER NEEDLE HOLDER.....	210
RETRACTOR KOCHER-KLANGENBECK.....	159	RIB SCISSORS BRUNNER.....	481		
RETRACTOR KOERTER.....	162	RIB SCISSORS CORYLLOS.....	480		
RETRACTOR KONIG.....	153	RIB SCISSORS GIERTZ-STILLE.....	481		
RETRACTOR LAHEY.....	157	RIB SCISSORS GLUCK.....	480		
RETRACTOR LANGENBECK.....	158, 159	RIB SCISSORS SAUERBRUCH.....	481		
RETRACTOR LANGENBECK-GREEN.....	153	RIB SCISSORS SAUERBRUCH-FREY.....	481		
RETRACTOR LITTLE.....	157	RIB SCISSORSSTILLE.....	480		
RETRACTOR LOVE.....	465	RIB SPREADER BAILEY.....	489		
RETRACTOR MARTIN.....	175/1	RIB SPREADER BAILEY-BABY.....	489		
RETRACTOR MATHIEU.....	141	RIB SPREADER COOLEY.....	489		
RETRACTOR MEYERDING.....	157, 177	RIB SPREADER COOLEY-NEONATAL.....	485		
RETRACTOR MEYERDING.....	177	RIB SPREADER DE BOER.....	486		
RETRACTOR MITTELDOERFF.....	160	RIB SPREADER FINOCCHIETTO.....	482, 484		
RETRACTOR MIKULICZ.....	163	RIB SPREADER FINOCCHIETTO-BURFORD.....	483		

S	
SAALFELD COMEDONE EXTRACTOR.....	608
SACHS DURA DISSECTOR.....	332
SACHS NERVE HOOK.....	328
SAENGER OVUM FORCEPS.....	606
SAGITTAL SPLIT RETRACTOR SMITH.....	463/5
SALPINGOGRAPHYSCHULTZE.....	596
SANVENERO SURGICAL SCISSORS.....	54
SAROT HEMOSTATIC CLAMP.....	118
SAROT NEEDLE HOLDER.....	211
SATINSKY TANGENTIALCLAMP.....	502
SATINSKY VASCULARSCISSORS.....	65/1
SATINSKY VASCULARSCLAMP.....	491

**Index
Indice
Indice
Verzeichnis**

SATO CORNEAL SCARIFIER.....	373	SCOVILLE NERVE HOOK.....	329, 330	SIEBENMANN IRRIGATION CANNULA.....	433/1
SATTERLEE AMPUTATION SAW.....	296	SCOVILLE-HAVERFIELD LAMINECTOMY RETRACTORRETRACTOR.....	196	SIEBOLD GYNECOLOGICAL SCISSORS.....	62
SAUERBRUCH BONE RONGEUR.....	240	SCREW DRIVER.....	232	SIEGLE EAR SPECULA.....	402
SAUERBRUCH RETRACTOR.....	164	SCREW DRIVER LANE.....	323	SILICONMATT.....	616
SAUERBRUCH RETRACTOR.....	164, 166	SCREW DRIVER WILLIAMS.....	323	SILVER DERMATOM.....	50
SAUERBRUCH RIB SCISSORS.....	481	SCREW HOLDING SLEEVE.....	324	SILVER SEPTUM CHISELS.....	442
SAUERBRUCH WASTEFORCEPS.....	227	SCUDDER BOWEL CLAMP.....	541	SILVERCLAMP.....	326
SAUERBRUCH-FREY STERNUM SCISSORS.....	481	SEBILEAU ELEVATOR.....	275	SIMCOE IRRIGATION CANNULA.....	394/2
SAW BLADES FOR AUTOPSY SAW.....	231/2	SECTION NEEDLE.....	268	SIMON RETRACTOR.....	164
SAW GIGLI.....	332	SEDILOTT RASPARTORIES.....	274	SIMON UTERINE CURETTE.....	594
SAWTELL TONSIL FORCEPS.....	467	SEGMENTED RING.....	194	SIMPLEX TUBING CLAMP.....	624
SAWYER RECTAL SPECULA.....	560	SEGOND HYSTERECTOMYCLAMP.....	125	SIMPSON OBSTETRICAL FORCEPS.....	602
SAYRE ELEVATOR.....	281	SEGOND MYOMA KNIVES.....	594	SIMPSON-BRAUN OBSTETRICAL FORCEPS.....	602
SCAGLIETTI BONE RONGEUR.....	240	SEGOND-LANDAU HYSTERECTOMYCLAMP.....	125	SIMPSON-LUIKART OBSTETRICAL FORCEPS.....	603
SCALP-CONTOUR RETRACTORS.....	169	SEIFERT INTERCHANGEABLE TIPS.....	472	SIMS GYNECOLOGICAL SCISSORS.....	62
SCALPEL.....	46	SELDIN RASPARTORY.....	277	SIMS RECTAL-SPECULA.....	559
SCALPEL MINI.....	41	SELLHEIM OBSTETRICAL CURETTE.....	607	SIMS UTERINE CURETTE.....	597
SCALPEL STERILE.....	43	SEMB BONE CUTTING FORCEPS.....	242	SIMS UTERINE DILATOR.....	581
SCALPEL-BLADE.....	42	SEMB BONE HOLDING FORCEPS.....	243	SIMS UTERINE-DEPRESSOR.....	586
SCALPEL-BLADE REMOVER.....	42	SEMB BONE RONGEUR.....	240	SIMS UTERINE-PROBES.....	586
SCALPEL-HANDLE.....	38, 39, 39/1, 39/2, 40, 42	SEMB BRONCHUSCLAMP.....	491	SIMS VAGINAL SPECULA.....	573
SCALPEL-HANDLE COLLIN.....	40	SEMB RASPARTORY.....	278	SIMS-MAIER DRESSINGFORCEPS.....	134
SCALPELHANDLE MINI.....	41	SEMKEN ANATOMIC TISSUE FORCEPS.....	86	SINGLE TISSUE FORCEPS.....	88
SCHAEDEL TOWEL CLAMP.....	132	SEMKEN SURGICAL TISSUE FORCEPS.....	86	SINKEY HOOK.....	376
SCHAMBERS COMEDONE EXTRACTOR.....	608	SEMM VAGINAL SPECULA.....	571	SINUS SEPTUM ELEVATOR.....	438
SCHAEDE BONE CURETTES.....	251	SENN-GREEN RETRACTOR.....	153	SINUSCOPY FORCEPS.....	431
SCHAEIE GONIOTOMY KNIVES.....	373	SENN-MILLER RETRACTOR.....	143	SINUSCOPY-TROCAR.....	438
SCHAEINMANN INTERCHANGEABLE TIPS.....	472	SEPTUM CANNULA.....	406	SINUS-PROBES.....	205
SCHERBAK VAGINAL SPECULA.....	575	SEPTUM CHISELS CINELLI.....	441	SIMSIMPACTOR FORCEPS ROWE.....	459
SCHINK DERMATOME.....	49	SEPTUM CHISELS COTTLE.....	440	SKENE HOOK FORCEPS.....	582
SCHIOETZ TONOMETER.....	394/2	SEPTUM CHISELS FOMON.....	441	SKIN HOOK COTTLE.....	447, 448
SCHLESINGER LAMINECTOMY RETRACTOR FORCEPS.....	342	SEPTUM CHISELS FREER.....	439	SKIN HOOK COTTLE-NEIVERT.....	448
SCHMEDEN NOSE FORCEPS.....	427	SEPTUM CHISELS SHEEHAN.....	441	SKIN HOOK FOMON.....	447/1
SCHMID VASCULAR-IRRIGATION CANNULA.....	338	SEPTUM CHISELS SILVER.....	442	SKIN HOOK FRAZIER.....	149
SCHMIEDEN GUIDEPROBES.....	221	SEPTUM ELEVATOR BALLENGER.....	439	SKIN HOOK FREER.....	448
SCHMIEDEN-DICK LIGATUREE NEEDLE.....	219, 221	SEPTUM ELEVATOR COTTLE.....	439	SKIN HOOK GILLIES.....	448
SCHMIEDEN-TAYLOR DURASCISSORS.....	65/1	SEPTUM ELEVATOR COTTLE-JOSEPH.....	439	SKIN HOOK GRAEFFE.....	149
SCHNIDT TONSIL FORCEPS.....	467	SEPTUM ELEVATOR FREER.....	437	SKIN HOOK GUTHRIE.....	149
SCHOENBORN THYROID GLAND HOOK.....	479	SEPTUM ELEVATOR HAJEK-BALLENGER.....	439	SKIN HOOK JOSEPH.....	149
SCHRÖDER HOOK FORCEPS.....	563, 584	SEPTUM ELEVATOR HALLE.....	437	SKIN HOOK KILNER.....	608
SCHRÖDER UTERINE CURETTE.....	595	SEPTUM ELEVATOR HOWARTH.....	437	SKIN HOOK KLEINERT-KUTZ.....	149
SCHROEDER(POZZI) HOOK FORCEPS.....	582	SEPTUM ELEVATOR JOSEPH.....	438	SKIN HOOK REDA.....	150
SCHUBERT BIOPSY FORCEPS.....	588	SEPTUM ELEVATOR KILLIAN.....	438	SKIN SCISSORS.....	610
SCHUKNECHT KNIVES.....	418	SEPTUM ELEVATOR MCKENTY.....	437, 438	SKIN STRAIGHTENING BLADE FOR DERMATOME.....	49
SCHULTZE SALPINGOGRAPH.....	596	SEPTUM ELEVATOR PENNINGTON.....	438	SKIN-PUNCH KEYE.....	608
SCHULZE-BERGMANN RECTAL-SPECULA.....	560	SEPTUM ELEVATOR PIERCE.....	438	SKIN-PUNCH KEYE.....	608
SCHUMACHER BIOPSY FORCEPS.....	588, 589	SEPTUM ELEVATOR ROGER.....	437	SKLEROTOM GUYTON-LUNDGAARD.....	373
SCHUMACHER EPISOTOMY SCISSORS.....	64	SEPTUM FORCEPS BRUENINGS.....	425	SKLEROTOM LUNDGAARD.....	373
SCHUMACHER INTERCHANGEABLE TIPS.....	472	SEPTUM FORCEPS HEYMANN.....	425	SLS CLIP FORCEPS.....	524
SCHUMACHER STERNUM SCISSORS.....	481	SEPTUM FORCEPS KNIGHT.....	425	SLIDER-BALLENGER.....	470
SCHWEIGGER CAPSULAR FORCEPS.....	391	SEPTUM FORCEPS LUC.....	426	SMELLIE HOOK.....	605
SCISSORS CASTROVIEJO.....	79	SEPTUM FORCEPS MIDDLETON-JANSEN.....	430	SMELLIE PERFORATORS.....	607
SCISSORS COTTLE.....	56	SEPTUM FORCEPS RUBIN.....	428	SMILLIE BONE LEVERS.....	291
SCISSORS DOYEN.....	63	SEPTUM GOUGES FREER.....	442/1	SMILLIE MENSICUSKNIVES.....	292
SCISSORS ENTEROTOMY.....	66	SEPTUM GOUGES HAJEK.....	442/1	SMITH EYE SPECULA.....	370
SCISSORS ENUCLEATION.....	58	SEPTUM GOUGES KILLIAN-CLAUS.....	442/1	SMITH SAGITTAL SPLIT RETRACTOR.....	463/5
SCISSORS GORNEY.....	73	SEPTUM KNIVES CONVERSE.....	435	SMITH US ARMY BANDAGE SCISSORS.....	69/1
SCISSORS GRAEFFE.....	56	SEPTUM KNIVES COTTLE.....	435	SMITH-BUIE ANAL RETRACTOR.....	561
SCISSORS HEPP-SCHIEDL.....	78	SEPTUM KNIVES FREER.....	434	SMITH-PETERSEN.....	261
SCISSORS MARTIN CARTILAGE.....	65/1	SEPTUM KNIVES JOSEPH.....	434, 435	SMITH-PETERSEN BONE RONGEUR.....	238
SCISSORS MICRO.....	76	SEPTUM SCISSORS KILLIAN.....	471	SMITHWICK APPLIERFORCEPS.....	326
SCISSORS NEUROSURGICAL.....	65	SEPTUM STRAIGHTENING FORCEPS ASCH.....	449	SMELLEN CATARACT LOOP.....	378
SCISSORS PARAMETRIUM.....	63	SEPTUM STRAIGHTENING FORCEPS WALSHAM.....	449	SNELLEN ENTROPIONUM FORCEPS.....	393
SCISSORS REES.....	73	SERPENTINE BIOPSY FORCEPS.....	593	SOMER UTERINE-GRASPING FORCEPS.....	585
SCISSORS SIEBOLD.....	62	SEUTIN BANDAGE SCISSORS.....	69/2	SPAREBLADE.....	49
SCISSORS SIMS.....	62	SEXTON EAR KNIVES.....	408	SPAREBLADE STERILE.....	50
SCISSORS THOREK.....	65/2	SHAPLEIGH EAR LOOP.....	410	SPATULA.....	203, 612
SCISSORS WAGNER.....	67	SHAYER KNIVES.....	49	SPATULA AND PACKER.....	612
SCISSORS WERTHEIM.....	63	SHEA MICRO-EAR SCISSORS.....	413	SPATULA HIRSCHMAN.....	379
SCOVILLE HOOK CURETTE.....	253	SHEEHAN CHISELS.....	441	SPECULA FRIEDMANN.....	577
SCOVILLE HOOK.....	196	SHEETS EYE CANNULA.....	394/2	SPECULA KALLMORGEN.....	573
SCOVILLE LAMINECTOMY RETRACTORRETRACTOR.....	196	SICKLE KNIVES REDA.....	435	SPECULA KRISTELLER.....	572

**Index
Indice
Index
Verzeichnis**

SPECULA O'SULLIVAN-O'CONNOR.....	576	STILLE RIB SCISSORS.....	480	SURGICAL SCISSORS STANDARD.....	51
SPENCER SUTURE SCISSORS.....	66	STILLE SURGICAL TISSUE FORCEPS.....	81	SURGICAL SCISSORS SYSTRUNK.....	66
SPENCER-WELLS HEMOSTATIC CLAMP.....	109	STILLE-BARRAYA VASCULARTISSUE FORCEPS.....	88	SURGICAL TISSUE FORCEPS.....	81
SPHYGMOMANOMETER BABYPHON.....	10	STILLE-HORSLEY BONE CUTTING FORCEPS.....	242	SURGICAL TISSUE FORCEPS ADSON.....	81/2
SPHYGMOMANOMETER DIPLOMAT.....	5	STILLE-LISTON BONE CUTTING FORCEPS.....	241	SURGICAL TISSUE FORCEPS ADSON MICRO.....	81/2
SPHYGMOMANOMETER EXACTA.....	8	STILLE-LUER BONE RONGEUR.....	239	SURGICAL TISSUE FORCEPS ADSON-BROWN.....	82
SPHYGMOMANOMETER MINIMUS.....	11, 12	STILLE-RUSKIN BONE RONGEUR.....	239	SURGICAL TISSUE FORCEPS BONNEY.....	88
SPHYGMOMANOMETER NOVA.....	6, 7	STILLE-SHERMAN BONE HAND DRILLS.....	298	SURGICAL TISSUE FORCEPS BROPHY.....	84
SPHYGMOMANOMETER PRECISA.....	9	STOCKMANN PENISCLAMP.....	553/1	SURGICAL TISSUE FORCEPS CUSHING.....	83
SPINAL BONE CURETTES.....	253	STOMACH CLAMP LANE.....	547	SURGICAL TISSUE FORCEPS FERRIS-SMITH.....	85
SPINAL HOOK TAYLOR.....	291	STOMACH-/BOWEL SUTUREING APPARATUS VP.ETZ.....	549	SURGICAL TISSUE FORCEPS GERALD.....	87
SPINA-NASALIS RETRACTOR.....	461	STOMACH-BOWEL CLAMP MIKULICZ.....	543	SURGICAL TISSUE FORCEPS GILLIES.....	86
SPLINTERFORCEPS ARCHER.....	92	STONE FORCEPS.....	545	SURGICAL TISSUE FORCEPS LANE.....	84
SPLINTERFORCEPS PEET.....	92	STONE HOLDING CLAMP.....	545	SURGICAL TISSUE FORCEPS OEHLER TC.....	81/1
SPLINTERFORCEPS VIRTUS (RALK).....	92	STRABISMUS FORCEPS BONACCOLTO.....	385	SURGICAL TISSUE FORCEPS POTTS SMITH.....	81
SPLINTERFORCEPSSTIEGLITZ.....	92	STRABISMUS FORCEPS DASTOOR.....	386	SURGICAL TISSUE FORCEPS SEMKEN.....	86
SPLINTERTISSUE FORCEPS.....	91	STRABISMUS FORCEPS JAMESON.....	385	SURGICAL TISSUE FORCEPS STILLE.....	81
SPLINTERTISSUE FORCEPS CARMALT.....	91	STRABISMUS FORCEPS MCCULLOUGH.....	385	SURGICAL TISSUE FORCEPS TAYLOR.....	87
SPLINTERTISSUE FORCEPS FELCHENFELD.....	91	STRABISMUS HOOK GRAEFE.....	375	SURGICAL TISSUE FORCEPS TYPE USA.....	81/1
SPLINTERTISSUE FORCEPS HUNTER.....	91	STRABISMUS HOOK JAMESON.....	375	SURGICAL TISSUE FORCEPS WAUGH.....	83
SPOON MEDICINE.....	621	STRANDELL-STILLE RETRACTOR.....	157	SUTUREFORC REDA.....	221
SPRATT BONE CURETTES.....	251	STRASSBURGER TISSUE FORCEPS.....	89	SUTURESCISSORS HEATH.....	66
SPREADER DAVIS-BOYLE.....	455	STRATTE NEEDLE HOLDER.....	212	SUTURESCISSORS LITTAUER.....	66
SPREADER DAVIS-MEYER.....	457	STRAUSS PENISCLAMP.....	553/1	SUTURESCISSORS NORTHBENT.....	66
SPREADER DINGMANN.....	456	STRIPPER.....	202	SUTURESCISSORS SPENCER.....	66
SPREADER KILNER-DOUGHTY.....	456	STRULLY NEUROSURGICAL.....	85	SUTUREING SET.....	225
SPURLING LAMINECTOMY RETRACTOR FORCEPS.....	340	STRUYCKEN NOSE FORCEPS.....	427	SWEET APPLIERFORCEPS.....	326
SPUTUM CUP.....	621	SUBRAMANIAN-MINIATURE.....	521	SYSTRUNK SURGICAL SCISSORS.....	66
SREW-HOLDINGFORCEPS LANE.....	325	SUCTION -IRRIGATION CANNULA.....	394		
ST.-CLAIR-THOMSON ADENOID CURETTE.....	450	SUCTION HANDLE WULLSTEIN.....	338	T	
ST.MARKS PELVIS-HOOK.....	165	SUCTION RASPIATORIES GULEN.....	433/1	TABB KNIVES.....	418
ST.MARTIN TISSUE FORCEPS.....	392	SUCTION TUBE ADSON.....	337/1	TABLET TRAY.....	621
STACKE EARPPOBES.....	199	SUCTION TUBE ANDREW-PYNCHON.....	28	TAKAHASHI NOSE FORCEPS.....	427
STAMMBERGER FORCEPS.....	431	SUCTION TUBE BABY-YANKAUER.....	27	TANGENTIALCLAMP DEBAKEY-SATINSKY.....	502
STAND.....	188	SUCTION TUBE BARON.....	336	TARNIER CRANIPLAST.....	607
STANDARD SURGICAL SCISSORS.....	51	SUCTION TUBE COOLEY.....	28	TARNIER OBSTETRICAL FORCEPS.....	604
STAUDE-MOORE HOOK FORCEPS.....	582	SUCTION TUBE DASTOOR.....	380	TAYLOR PERCUSSION HAMMER.....	24
STEINMANN ENDER NAIL.....	307, 308	SUCTION TUBE DEBAKEY.....	28	TAYLOR SPINAL HOOK.....	291
STEINMANN TENDON HOLDINGFORCEPS.....	292	SUCTION TUBE FRAZIER/FERGUSSON.....	337	TAYLOR SURGICAL TISSUE FORCEPS.....	87
STELLBRINK BONE RONGEUR.....	234	SUCTION TUBE PLESTER.....	338	TC SCISSORS FREEMAN.....	74
STERILE SCALPEL.....	43	SUCTION TUBE POOLE.....	27	TC SCISSORS PECK-JOSEPH.....	74
STERILE SCALPEL-BLADE.....	42	SUCTION TUBE ROSEN.....	338	TC SCISSORS REES.....	73
STERILE SPARE BLADE.....	50	SUCTION TUBE TUBE KLEINSASSER.....	36	TC SURGICAL SCISSORS FINE REYNOLDS TC.....	54
STERILIZATION CLAMP BUNT.....	227	SUCTION TUBE YANKAUER.....	337/1	TC SURGICAL SCISSORS STANDARD.....	51
STERILIZATION CLAMP MAYO.....	227	SUCTION TUBE YASARGIL.....	337/1	TC TISSUE FORCEPS CUSHING.....	83
STERILIZATION FORCEPS.....	227	SUCTION TUBE ZOELLNER.....	337/1	TC TISSUE FORCEPS GILLIES.....	86
STERILIZATION FORCEPS.....	227	SUCTION TUBEEO HOUSE.....	337/2	TC TISSUE FORCEPS SEMKEN.....	86
STERILIZATION FORCEPS CHEATLE.....	227	SUPERCUT SCISSORS.....	71	TC TISSUE FORCEPS SURGICAL.....	86
STERILIZATION FORCEPS REDA.....	615	SUPERCUT SCISSORS BABY METZENBAUM.....	71	TC TISSUE FORCEPS WANGENSTEEN.....	89
STERILIZATION FORCEPS ROGGE.....	227	SUPERCUT SCISSORS FREEMAN.....	74	TC TISSUE FORCEPSN ANATOMIC.....	81
STERILIZATION FORCEPS UNIVERSAL.....	227	SUPERCUT SCISSORS GORNEY.....	73	TC-SCISSORS GORNEY.....	73
STERILIZATION TRAY.....	622, 623	SUPERCUT SCISSORS IRIS.....	72	TC-SCISSORS KAYE.....	73
STERILIZATION TRAY.....	616, 618	SUPERCUT SCISSORS KAYE.....	73	TEALE HOOK FORCEPS.....	583
STERNBERG CHEEK RETRACTOR.....	453	SUPERCUT SCISSORS KILNER/RAGNELL.....	72	TEBBETTS RETRACTOR.....	197
STERNUM SCISSORS SCHUMACHER.....	481	SUPERCUT SCISSORS LAGRANGE.....	72	TEETH TISSUE FORCEPS LONDON-COLLEGE.....	93
STERNUMCHISELS LEBSCHE.....	267	SUPERCUT SCISSORS LISTER.....	72	TEETH TISSUE FORCEPS MERIAM.....	93
STETHOSCOPE ANESTOPHON.....	23	SUPERCUT SCISSORS MAYO.....	71	TENDON GRASPING FORCEPS.....	293
STETHOSCOPE DUPLEX.....	23	SUPERCUT SCISSORS MAYO-STILLE.....	71	TENDON GRASPING FORCEPS JACKSON.....	292
STETHOSCOPE PINARD.....	23	SUPERCUT SCISSORS METZENBAUM.....	71	TENDON GRASPING FORCEPS LARSEN.....	292
STEVENS IRIS TISSUE FORCEPS.....	383	SUPERCUT SCISSORS REES.....	73	TENDON GRASPING INSTR KLEINERT-KUTZ.....	294
STEVENS LENSENHOOK.....	375	SUPERCUT SCISSORS REYNOLDS.....	72	TENDON GRASPING INSTRUMENT BRAND.....	293
STEVENS NEEDLE HOLDER.....	214	SUPERCUT SCISSORS STEVENS.....	72	TENDON GRASPING INSTRUMENT CAROLL.....	293
STEVENS OPHTHALMOLOGIC SCISSORS.....	58	SUPERCUT SCISSORS WAGNER.....	72	TENDON GUIDE BUNELL.....	294
STEVENS SUPERCUT SCISSORS.....	72	SURGICAL NEEDLE.....	222, 223	TENDON HOLDINGFORCEPSSTEINMANN.....	292
STEVENSON EYE SPECULA.....	371	SURGICAL NEEDLE KEITH.....	223	TENDON PASSING INSTR. BRAND.....	294
STIEGLITZ SPLINTERFORCEPS.....	92	SURGICAL NEEDLE KOENIG.....	223	TENDON PASSING INSTR. BUNNELL.....	292
STILLE ANATOMIC TISSUE FORCEPS.....	81	SURGICAL SCISSORS FERGUSSON.....	66	TERSON CAPSULAR FORCEPS.....	391
STILLE BONE HAND DRILLS.....	298	SURGICAL SCISSORS FINE IRIS.....	54	TESSIER RETRACTOR.....	463/3
STILLE CHISELS.....	260	SURGICAL SCISSORS FINE JOSEPH.....	54	T-HANDLE.....	300, 301
STILLE CHISELS.....	260	SURGICAL SCISSORS FINE KILNER.....	54	T-HANDLE HUDSON.....	300
STILLE GOUGES.....	260	SURGICAL SCISSORS FINE REYNOLDS.....	54	THOMAS UTERINE CURETTE.....	599
STILLE HEMOSTATIC CLAMP.....	122	SURGICAL SCISSORS FINE SANVENERO.....	54	THOMAS-GAYLOR BIOPSY FORCEPS.....	588
STILLE PLASTERS/SCISSORS.....	229	SURGICAL SCISSORS METZENBAUM.....	51, 54	THOMS-ALLIS BOWEL GRASPING FORCEPS.....	538

**Index
Indice
Index
Verzeichnis**

UTERINE CURETTE SIMS	597	VERBRUGGE BONE HOLDING FORCEPS	245	WILLIAMS SCREW DRIVER	323
UTERINE CURETTE THOMAS	599	VERBRUGGE-MÜLLER BONE LEVERS	287	WILLIGER CURETTE	255, 257
UTERINE DILATATOR GOODELL	581	VERESS INSUFFLATION CANNULA	206	WILLIGER HAMMER	271
UTERINE DILATATOR HANK	580	VIENNA GUIDE PROBES	221	WILLIGER RASPORIES	276
UTERINE DILATATOR HEGAR	578, 579	VIRCHOW POST MORTEM KNIVES	48	WINTER OVUM FORCEPS	606
UTERINE DILATATOR PRATT	580	VIRTUS(PALQ) SPLINTERZ	92	WIRE BASKET FOR ENDOSCOPE	623
UTERINE DILATATOR SIMS	581	VOLKMANN BONE CURETTES	251	WIRE FORCEPS	317, 318
UTERINE DILATATOR WYLIE	581	VOLKMANN CURETTE	257	WIRE FORCEPS BERRY TC	319
UTERINE POLYP FORCEPS DOYEN	585	VOLKMANN RETRACTOR	153	WIRE FORCEPS CORWIN-HEGAR TC	319
UTERINE POLYP FORCEPS KELLY	585	VOLKMANN RETRACTOR	153, 156	WIRE FORCEPS MAYO-HABERISSER TC	319
UTERINE POLYP FORCEPS NOTO	585	VOLTOLINI NOSE SPECULA	421	WIRE GAUZE	319
UTERINE-DEPRESSOR BRAUN	586	VU-MORE VAGINAL SPECULA	569	WIRE GRASPING FORCEPS	318
UTERINE-DEPRESSOR SIMS	586			WIRE GUIDE NEEDLE DEMEL	315
UTERINE-GRASPING FORCEPS COLLIN	585	W		WIRE INSTRUMENT DEMEL	315
UTERINE-GRASPING FORCEPS DARTIGUES	585	WACHENFELDT CLIP TISSUE FORCEPS	224	WIRE INSTRUMENT LOUTE	315
UTERINE-GRASPING FORCEPS SOMER	585	WADSWORTH-TODD CAUTER	378	WIRESAW OLIVECRONA	332
UTERINE-KL-FORCEPSGREEN-ARMYTAGE	605	WAGENER-MOSHER TRACHEA CANNULA	477	WIRESAW UNIVERSAL	67
UTERINE-PROBES COLLIN	586	WAGNER HOOK	409	WITNER BIOPSY FORCEPS	589
UTERINE-PROBES MARTIN	586	WAGNER LAMINECTOMY RETRACTOR FORCEPS	343	WOLFF PLASTER FORCEPS	233
UTERINE-PROBES SIMS	586	WAGNER SCISSORS	67	WOODSON DURA DISSECTOR	333
		WAGNER SUPERCUT SCISSORS	72	WORST PROBES	333
V		WALDMANN EPISOTOMY SCISSORS	64	WOUND CURETTE ARRUGA	378
VAGINAL SPECULA	569	WALLICH OVUM CURETTE	607	WRIGLEY OBSTETRICAL FORCEPS	402
VAGINAL SPECULA JACKSON	573	WALSHAM SEPTUM STRAIGHTENING FORCEPS	449	WULLSTEIN KNIVES	618
VAGINAL SPECULA AUWARD	576	WALTON FOREIGN-BODY GOUGES	374	WULLSTEIN MICRO-CURETTE FORCEPS	416
VAGINAL SPECULA BREISKY	577	WALTON COMEDONE EXTRACTOR	608	WULLSTEIN RETRACTORS	171
VAGINAL SPECULA COLLIN	570	WALTON FINGER RING SAW	297	WULLSTEIN SUCTION HANDLE	338
VAGINAL SPECULA CUSCO	570	WANGENSTEEN VASCULARTISSUE FORCEPS	89	WYLIE UTERINE DILATOR	581
VAGINAL SPECULA DOYEN	574	WARTENBERG PINWHEEL	25		
VAGINAL SPECULA GRAVE	570	WASTEFORCEPS SAUERBRUCH	227	Y	
VAGINAL SPECULA KRISTELLER	572	WATER JET PISTOL	626	YANCOOSKIE RETRACTOR	198
VAGINAL SPECULA LANDAU	577	WATSON DERMATOM	50	YANKAUER SUCTION TUBE	27
VAGINAL SPECULA PEDERSON	570	WATSON DERMATOM	50	YANKAUER TONSIL DISSECTOR	465
VAGINAL SPECULA SEMM	571	WATSON-CHEYNE	283	YASARGIL ANEURYSM	
VAGINAL SPECULA SIMS	573	WATSON-CHEYNE PROBES	199 349, 350, 351, 352, 353, 354, 355, 356	
VAGINAL SPECULA TRELAT	571	WATSON-WILLIAMS NOSE FORCEPS	428	YASARGIL GALEAHOOK	330
VAGINAL SPECULA VU-MORE	569	WAUGH SURGICAL TISSUE FORCEPS	83	YASARGIL SUCTION TUBE	337/1
VAGINAL SPECULASCHERBAK	575	WEBER BLOOD VESSEL CLAMP	501	YASARGIL TUMORTISSUE FORCEPS	97
VALLEIX PROBES	586	WEBER CATARACT LOOP	378	YEOMAN RECTAL BIOPSY FORCEPS	566, 567
VAN BUREN BONE HOLDING FORCEPS	249	WEBSTER NEEDLE HOLDER	208	YOUNG BOOMERANG	220
VAN BUREN DILATION BOUGIE	554	WECKER EYESCISSORS	75	YOUNG PROSTATIC HOOK	550
VAN DOREN BIOPSY FORCEPS	588	WECKER IRIS SPATULA	378	YOUNG TONGUE FORCEPS	453
VANNAS EYESCISSORS	79	WEEK EYE SPECULA	370		
VARADY VARIX INSTRUMENT	202	WEIL-BLAKESLEY NOSE FORCEPS	426	Z	
VARICOSE VEIN PROBES NABATOFF	201	WEITLANER RETRACTORS	169	ZAUFAL EAR LEVER	409
VARIX INSTRUMENT VARADY	202	WEITLANER-WULLSTEIN RETRACTORS	169	ZAUFAL-JANSEN BONE RONGEUR	238
VASCULAR CLAMP BAINBRIDGE	495	WELLER DISSECTING SCISSORS	53/2	ZAUFAL-JANSEN EAR LEVER	409
VASCULAR CLAMP COOLY	518, 522	WELLS ENUCULATION CURETTE	378	ZENKER HEMOSTATIC CLAMP	118
VASCULAR CLAMP DE BAKEY	495	WERTHEIM GYNECOLOGICAL SCISSORS	63	ZENKER RETRACTOR	161
VASCULAR CLAMP DEBAKEY	507, 514, 515	WERTHEIM HYSTERECTOMY CLAMP	124, 128	ZIEGLER DISCISION KNIVES	373
VASCULAR CLAMP DEBAKEY CHILDREN	516	WERTHEIM HYSTERECTOMY SCISSORS	63	ZIEGLER EYE SPECULA	371
VASCULAR CLAMP GLOVER	515	WERTHEIM-CULLEN HYSTERECTOMY CLAMP	125	ZIEGLER HEAD MIRRORS	21
VASCULAR CLIP BIEMER	361	WEST NOSE CHISELS	442	ZIEGLER IRIS KNIVES	372
VASCULAR CLIP MEHDORN	362	WESTCOTT EYESCISSORS	75	ZIEGLER LACHRYMAL DILATOR	381
VASCULAR CLIP MUELLER	365	WESTMACOTT NOSE DRESSING FORCEPS	424	ZIELKE GOUGES	264
VASCULAR SCISSORS DE BAKEY	61	WESTON RECTALSNARE	566	ZIOLLNER SUCTION TUBE	337/1
VASCULAR SCISSORS DEBAKEY TC	60	WHEELER CYCLODIALYSIS SPATULA	379		
VASCULAR SCISSORS DIETRICH	60	WHEELER DISSECTION KNIVES	373		
VASCULAR SCISSORS FAVALORO	61	WHITE TONSIL FORCEPS	467		
VASCULAR SCISSORS KELLY	61	WIBERG RASPORIESIUM	277		
VASCULAR SCISSORS POTTS-SMITH	61	WIEDER TONGUE DEPRESSORS	452		
VASCULAR-CANNULA SCHMID	338	WIENER ANTRUM RASP	443		
VASCULAR-DILATOR DEBAKEY	529	WIENER IRIS HOOK	375		
VASCULARDISSECTOR ROBB	530	WIGMORE PLASTER KNIVES	229		
VASCULARSCISSORS KLINKENBERG-LOTH	65/2	WIKSTROEM HEMOSTATIC CLAMP	117		
VASCULARSCISSORS POTTS-DE MARTEL	59	WILDE POLYP SNARE	411		
VASCULARSCISSORS SATINSKY	65/1	WILDE POLYP SNARE	433/2		
VASCULARSCLAMP DIEFFENBACH	104	WILDE(TROELTSCH) EAR FORCEPS	410		
VASCULARSCLAMP SATINSKY	491	WILDER PROBE	381		
VASCULARTISSUE FORCEPS ADLERKREUTZ	84	WILDER CATARACT LOOP	378		
VASCULARTISSUE FORCEPS NELSON	89	WILLET MARTEL GRASPING FORCEPS	110		
VASCULARTISSUE FORCEPSSITTLE-BARRAYA	88	WILLIAMS BOWEL GRASPING FORCEPS	539		
VASEKTOMICELAMP	553/2	WILLIAMS EYE SPECULA	370		

The logo features a stylized 'PMG' monogram in black and blue, followed by the text 'Princeton Medical Group' in a blue serif font.

Princeton
Medical Group

1601 Championship Blvd. Suite 233 Franklin, TN 37064
800 – 875 – 0869 / Fax: 615 – 791 – 8598
www.princetonmedical.net

